

BOSS **DS-2** TURBO Distortion

INSTRUCTIONS

Please read the instructions carefully.

- The DS-2 is a new type distortion unit that features a newly developed turbo circuits.
- All the circuits adopt discrete system, therefore there is very low noise created.
- Two types of distortions are optional by changing the Turbo Modes.
- The turbo I / II. can be controlled by using the footswitch connected to the Remote Jack.

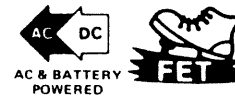
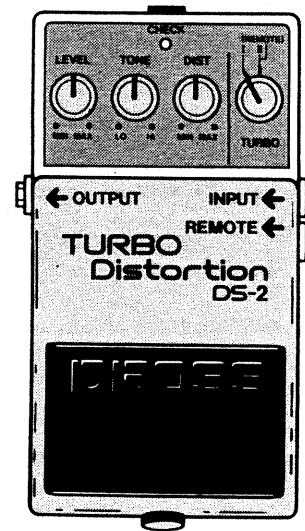

■ SPECIFICATIONS

Power: 9VDC006P × 1, AC Adaptor (PSA series)

Current Draw: 12mA

Controls: Distortion, Tone, Level

Switches: Turbo I/II, Effect ON/OFF

Indicator: Effect ON/OFF (=Battery Check)

Jacks: Input, Output, Remote, AC Adaptor

Equivalent Input Noise: Less than -120dBm (IHF-A)

Input Impedance: 1MΩ

Output Load Impedance: More than 10kΩ

Dimensions: 70(W) × 55(H) × 125(D) mm / 2-3/4" × 2-3/16" × 4-15/16"

Weight: 400g / 14oz

*Specifications are subject to change without notice.

BOSS
Products of Roland

Printed in Taiwan '95-8-D3-11C

BOSS **DS-2**
TURBO
Distortion

INSTRUCTIONS

Please read the instructions carefully.

- The DS-2 is a new type distortion unit that features a newly developed turbo circuits.
- All the circuits adopt discrete system, therefore there is very low noise created.
- Two types of distortions are optional by changing the Turbo Modes.
- The turbo I / II can be controlled by using the footswitch connected to the Remote Jack.



PANEL DESCRIPTION

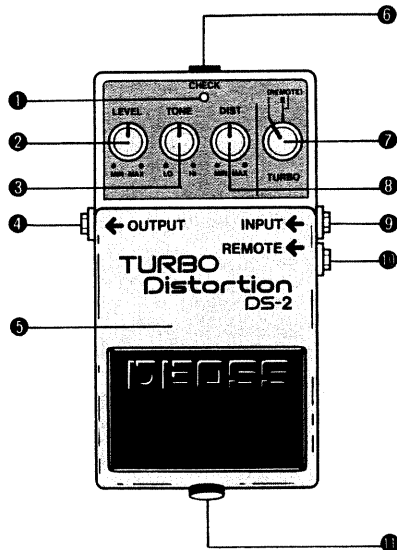

1 Check Indicator

This lights up when the effect is turned on, and therefore can be used as an effect on/off indicator.

* This indicator also serves as battery check. When it becomes dimmer or does not light at all, battery replacement is required.

2 Level Knob

This adjusts the volume of the effect sound. Clockwise rotation raises the volume and counterclockwise rotation decreases.

3 Tone Knob

This adjusts the tone of the effect sound. As you rotate the knob clockwise, higher frequencies are emphasized, and counterclockwise cuts them.

4 Output Jack

Connect an amplifier to this jack.

5 Pedal Switch

Pressing the pedal turns on or off the effect.

6 AC Adaptor Jack

Connect an AC adaptor (BOSS PSA-120, 220 or 240) to this jack for long and secure operation.

7 Turbo Mode Selector Switch

This selects the Turbo Mode I or II. (See "OPERATION" for details.)

8 Distortion Knob

This adjusts the depth of the distortion effect. Rotating the knob clockwise deepens the distortion creating powerful distortion effect. Rotating the knob counterclockwise makes lighter distortion.

9 Input Jack

Connect an electronic musical instrument such as a guitar to this jack.

* Plugging in this jack will automatically switch the unit on. Be sure to disconnect the cord from this jack when the unit is not to be used.

10 Remote Jack

By connecting an optional footswitch such as FS-5L to this jack, you select the Turbo Mode I or II using the pedal.

* To obtain the above remote controlling function, be sure to set the Turbo Mode Switch to the II (REMOTE) position.

11 Thumb Screw

Loosen the screw to open the cover for battery replacement.

* Do not remove the screw from the cover, or you may lose it.

OPERATION

- Make all the necessary connections, then set the controls on the panel as shown below.

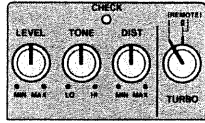

- Press the Pedal Switch and make sure that the Check Indicator lights up.



- Set the Turbo Mode Selector Switch to the desired position, I or II.



TURBO

Turbo I

Turbo I mode gives a powerful distortion sound because of the Turbo circuits. Featuring flat characteristics, the created sound is not muffled even when the volume is turned down. Also the distortion circuits serve to remove unpleasant shrill caused when the sound is extremely distorted.

Turbo II

Sticky distortion with unique characteristic in middle range sound. The turbo circuits serve to create powerful sounds.

- Adjust the depth of distortion with the Distortion Knob.



- Adjust the tone of distortion with the Tone Knob.



- Adjust the volume of the distortion with the Level Knob.



SETTING EXAMPLES

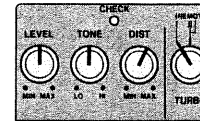

The most usual distortion sound.

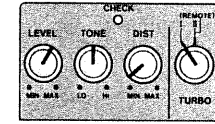

Light distortion. With the guitar's volume turned down, almost normal sound with little distortion is obtained.

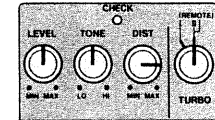

Sticky distortion with unique characteristic in middle range sound. Suitable for lead guitar.

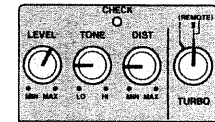

Overdrive like sounds with higher frequencies cut off.

CONNECTION

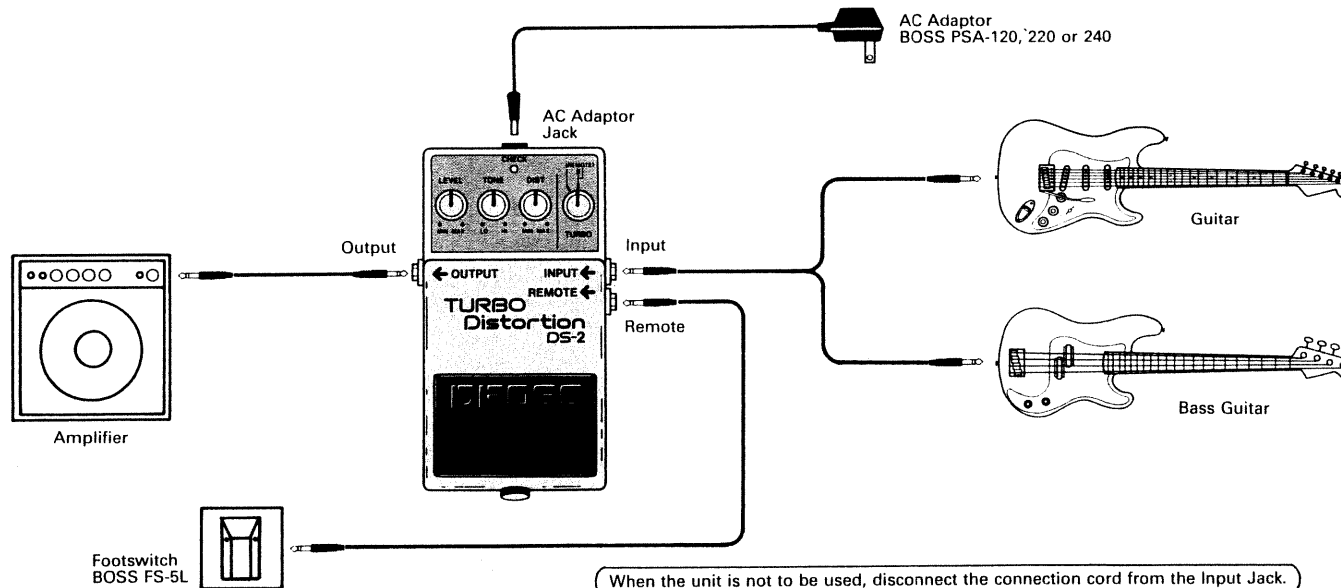

CAUTIONS

- The BOSS manganese battery will last for 10 to 20 hours depending on how you use the unit.
- If the battery voltage drops (the Check Indicator lights dimmer), various symptoms are shown, such as the effect becomes weak, no sound is produced, etc. To prevent that, replace the battery immediately.
- When the unit is not to be used for a long period of time, remove the battery to prevent problems caused by battery leakage.
- Plugging in the Input Jack automatically turns the unit on, so disconnect the cord from the Input Jack when the unit is not in use.
- Avoid using this unit in extreme heat or humidity, or where it may be affected by dust.

■ BATTERY REPLACEMENT

- ① Loosen the Screw of Pedal to open it.
- ② Take out the battery from the Battery Housing and disconnect the Battery Snap.
- ③ Replace with a new battery and connect the Battery Snap.
 - * Be sure that the polarity (+/-) is correct
- ④ Put the Coil Spring to the Spring Base and close the Pedal.
 - * Make sure that the Battery Snap is not caught in the Pedal or Coil Spring.
- ⑤ Insert the screw into the Guide Bush Hole and firmly tighten the screw.

▷ USE ONE 9-VOLT BATTERY

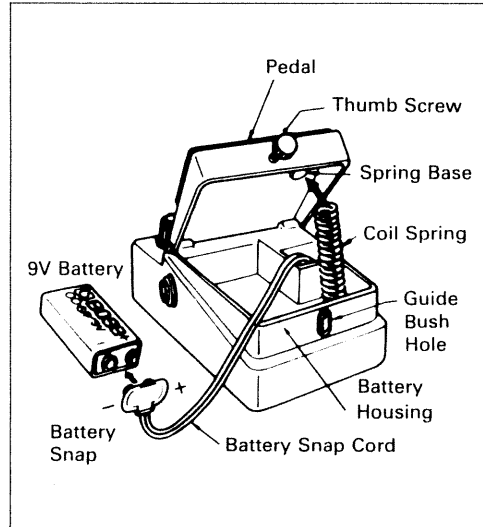

■ AC ADAPTOR

- Be sure to use the AC Adaptor BOSS PSA-120, 220 or 240 depending on the line voltage system in your country.
- Do not use the same socket used for any noise generating or large power consuming device such as a motor, variable lighting system, etc.
- Connect the AC adaptor to the AC Adaptor Jack on the unit, then make sure that nothing is connected to the Input Jack, before connecting the power plug to the socket.
- Be sure to keep the battery securely connected even while using the AC adaptor, then the unit will continue to operate even if the AC adaptor cord comes out during performance.
- When the unit is not in use, disconnect the AC adaptor from the socket.

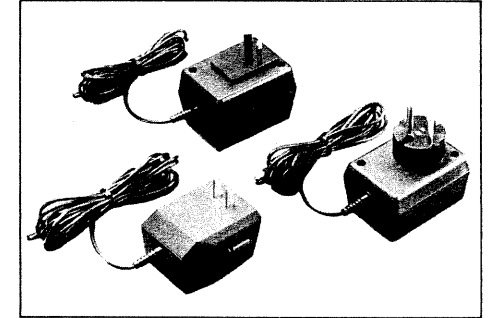

SETTING MEMO

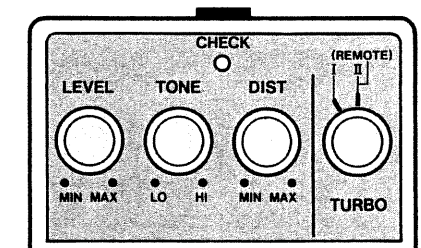
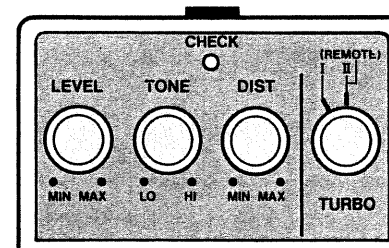
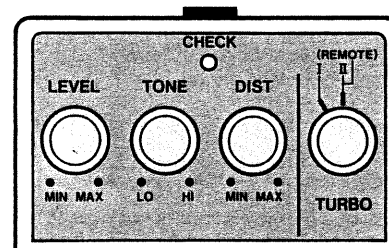
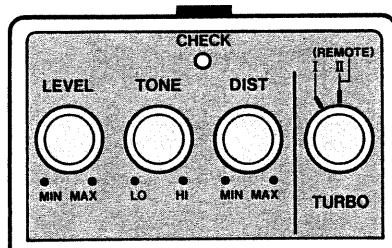
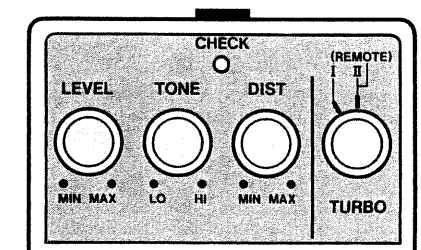
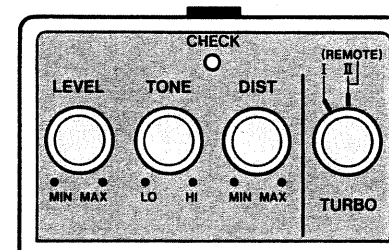
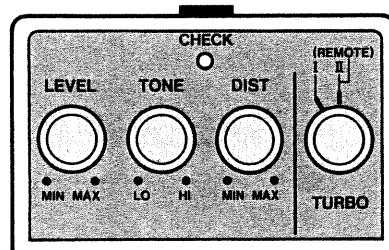
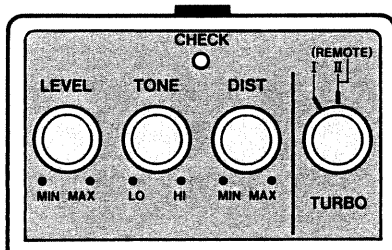

 Roland®

2603070200

UPC

2603070200



18981

 **BOSS**