

# ATOMSTACK Air Assist Kit User Manual



- English
- Deutsche
- Français

Note: The picture is for reference only, the actual product shall prevail.

F03-0046-0AA1 Version:C

For more information, please scan the QR code













Laser Engraver

# Parts List

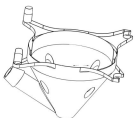
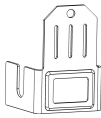
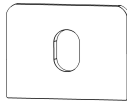

This is parts collection for various models, not each model will use all parts in the sheet.

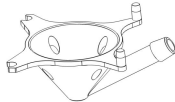
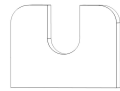
 <p>Pump</p>	 <p>Power Adapter</p>	 <p>trachea</p>	 <p>M3 self-tapping screws</p>	 <p>Set screw</p>	 <p>Inner hexagon screwdriver</p>	 <p>PH1 Phillips screwdriver</p>
 <p>Foot pad 2pcs</p>	 <p>NO. 1 2pcs</p>	 <p>NO. 1-1</p>	 <p>NO. 1-2</p>	 <p>NO. 1-3</p>	 <p>NO. 2</p>	 <p>NO. 2-1</p>

Atomstack A5 10W	Atomstack A5 30W
Atomstack A5 20W	Atomstack A5 Pro

# Installation of Air Guide Hood for Four Models

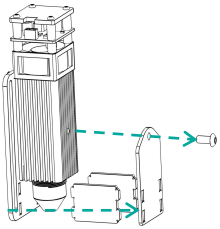

1. Remove the current acrylic shields

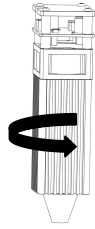

2. Rotate the laser backward 180°

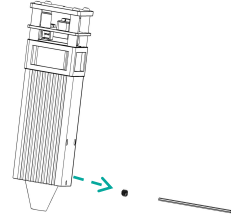

3. Remove the set screw

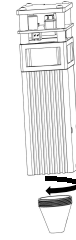

4. Rotate the current air guide hood counterclockwise to remove it.

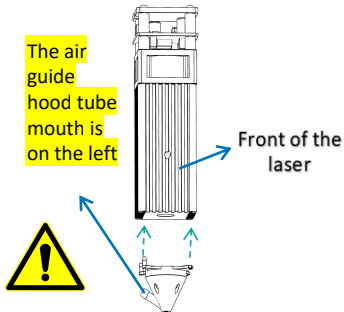

5. Find **NO.1** from the accessories. Install it as shown

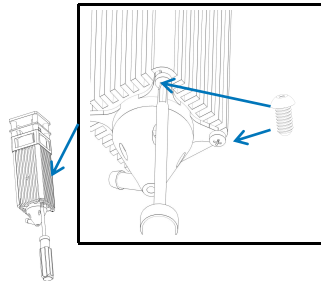

6. Tighten the self-tapping screws with a PH1 Phillips screwdriver

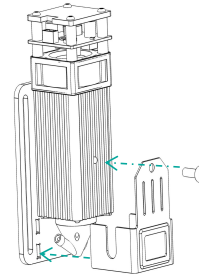

7. Find **NO.1-1** from the accessories and install it as shown.

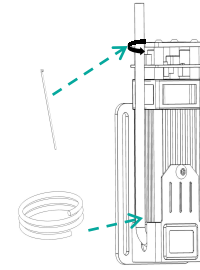

8. Insert the tube and fixed it with a tie

Atomstack A5 M50 Pro	AtomStack P9 M40	Atomstack X7 Pro	AtomStack P9 M50
AtomStack A10 PRO	Atomstack A5 M50	Atomstack S10 Pro	Atomstack X7

## Installation of Air Guide Hood for Eight Models

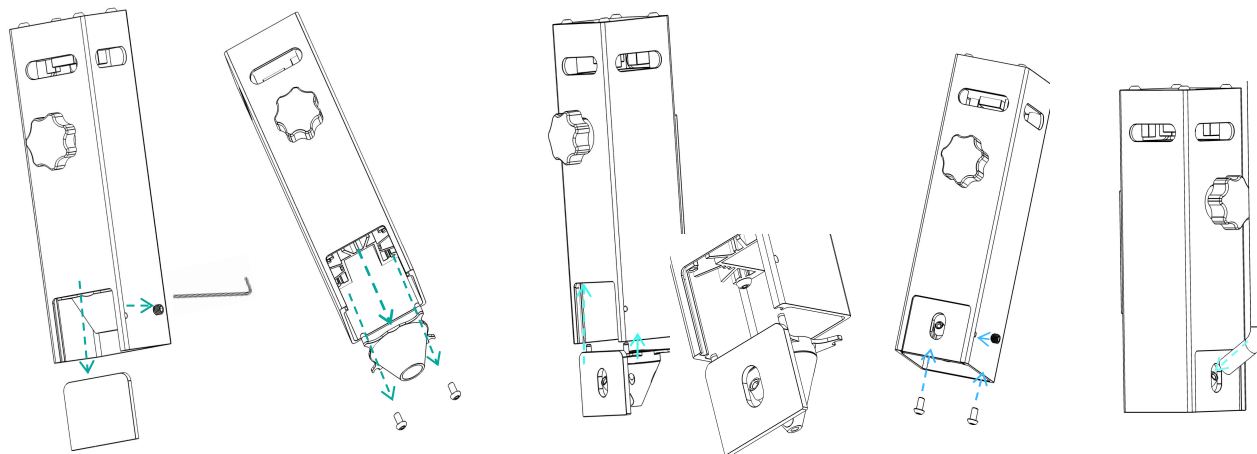

1. Remove the set screw from the right side of the laser and remove the current filter glass or acrylic shield.

2. Remove the current air guide hood.

3. Find **NO.1** and **NO.1-2** from the accessories and install them at the same time as shown.

4. Fix the air guide hood as well as the filter glass.

5. Insert the tube.



If your model is **AtomStack A5 Pro+** or **AtomStack P7 M40**, you need to choose one of the following 2 combinations to support your model.

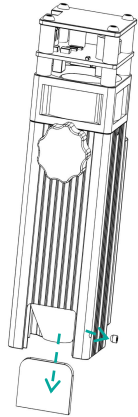

1. Remove the set screw from the right side of the laser and remove the current filter glass or acrylic shield.



2. Remove the current air guide hood.

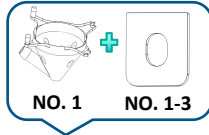

Combination one

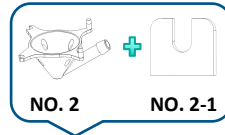

Combination two

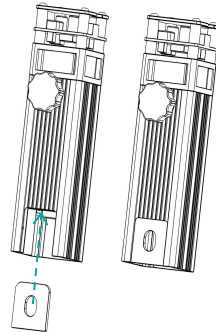

3-1

3-2

locate the combination which contains the wind deflector matches your model( If the bottom surface of the glass and the laser is flush after assembly, proves this wind deflect matches your model), choose this combination.

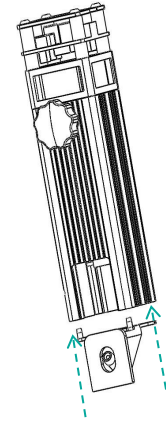

4. Install the combination matches your model, mount the air guide hood and the glass at the same time.

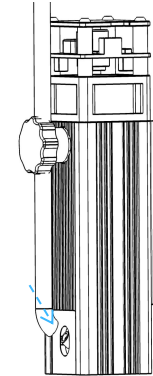

5. Insert the tube.

# Equipment installation and use

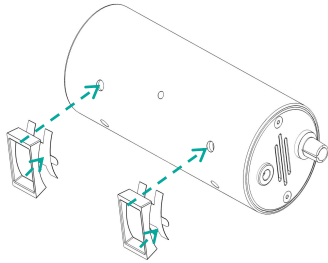

1. Tear off the adhesive protect paper from the silicone pad, align the positioning posts on the silicone pad with the mounting holes on the pump, and paste the silicone pad to pump body.

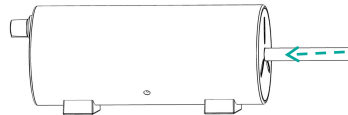

2. Insert the air tube into the air pump port

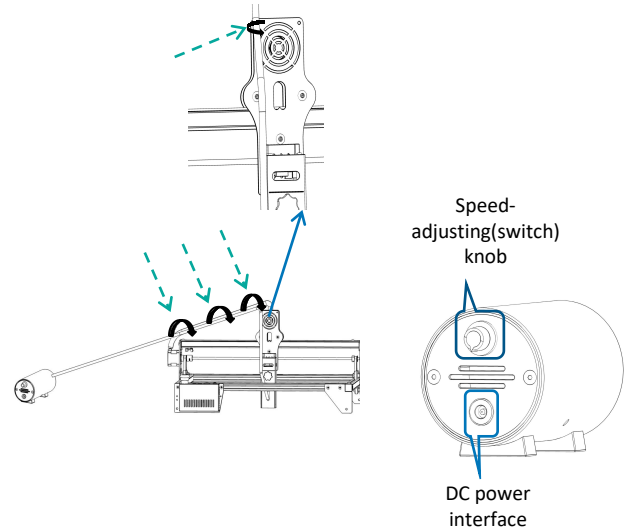

3. The tube on the machine needs to be fixed with the connecting line by the nylon tie. Be careful not to fix it too tight to block the tube.

## Precautions for Use

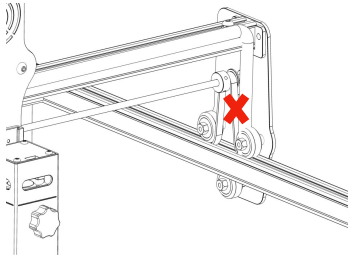

Be careful not to get the tube stuck by the wheels.

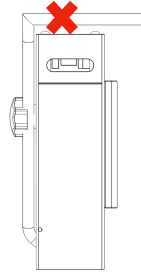

Please do not bend the tube too much to make the tube blocked.

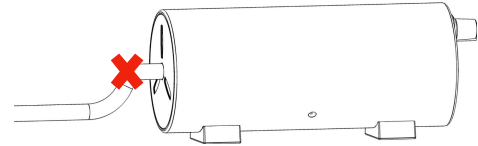

Please note the tube cannot be bent too much to make the tube blocked.



After using the air guide hood of air assist ,please clean the adhesions on the air outlet to prevent from accumulating for a long time to affect the further use.



**Customer Service:**

- For detailed warranty policy, please visit our official website at: [www.atomstack.com](http://www.atomstack.com)
- For technical support and service, please email: [support@atomstack.com](mailto:support@atomstack.com)

**Manufacturer:** Shenzhen AtomStack Technologies Co., Ltd.  
Address: 17th Floor, Building 3A, Phase II, Intelligent Park, No. 76,  
Baohe Avenue, Baolong Street, Longgang Dist., Shenzhen, 518172,  
China.

Scan the code to enter the discussion group.



Scanner APPLICATION:  
QR code reader/ Barcode scanner or any APP with scanner.



# ATOMSTACK Air Assist Kit Benutzerhandbuch

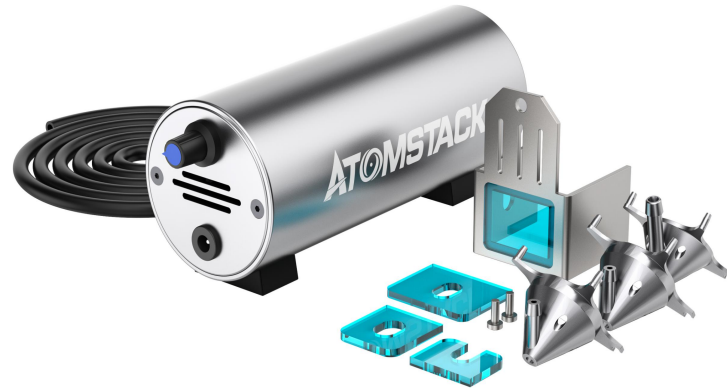

- English
- Deutsche
- Français

Hinweis: Das Bild dient nur als Referenz, das tatsächliche Produkt hat Vorrang

Für weitere Informationen scannen Sie bitte den QR-Code











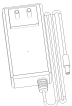

Laser Engraver

# Liste der Einzelteile

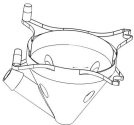
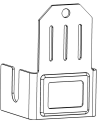
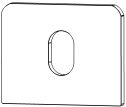

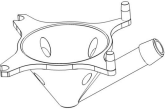
Dies ist eine Teilesammlung für verschiedene Modelle, nicht jedes Modell verwendet alle Teile im Blatt.

 <p>Pumpe</p>	 <p>Netzteil</p>	 <p>Luftröhre</p>	 <p>M3 selbstschneiden de Schrauben</p>	 <p>Feststells chraube</p>	 <p>Innensechskant- Schraubendreher</p>	 <p>PH1Kreuzschlitz chraubendreher</p>
 <p>Fußpolster 2St</p>	 <p>NEIN. 1 2St</p>	 <p>NEIN. 1-1</p>	 <p>NEIN. 1-2</p>	 <p>NEIN. 1-3</p>	 <p>NEIN. 2</p>	 <p>NEIN. 2-1</p>

Atomstack A5 10W	Atomstack A5 30W
Atomstack A5 20W	Atomstack A5 Pro

# Installation der Luftführungshaube für vier Modelle

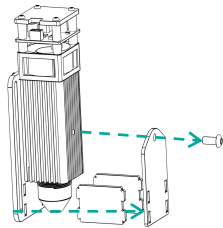

1. Entfernen Sie die aktuellen Acrylabschirmungen



Die Rohrmündung der Luftführungshaube befindet sich auf der linken Seite

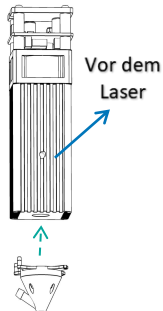

5. Finden Sie **NEIN. 1** aus dem Zubehör. Wie abgebildet installieren

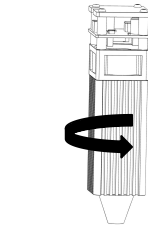

2. Drehen Sie den Laser um 180° nach hinten

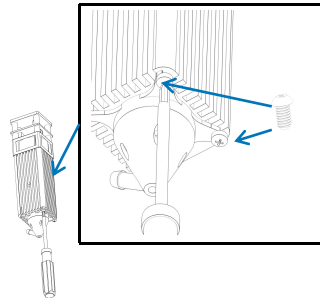

6. Ziehen Sie die Parkerschrauben mit einem Kreuzschlitzschraubendreher PH1 fest

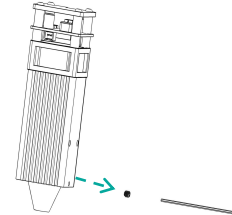

3. Entfernen Sie die Stellschraube

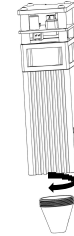

4. Drehen Sie die aktuelle Luftführung gegen den Uhrzeigersinn, um es zu entfernen

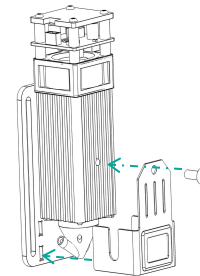

7. Finden Sie **NEIN.1-1** aus dem Zubehör und installieren Sie es wie in der Abbildung gezeigt

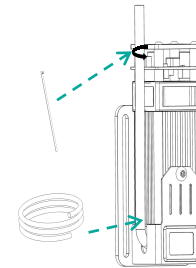

8. Führen Sie das Rohr ein und befestigen Sie es mit einem Kabelbinder

Atomstack A5 M50 Pro	AtomStack P9 M40	Atomstack X7 Pro	AtomStack P9 M50
AtomStack A10 PRO	Atomstack A5 M50	Atomstack S10 Pro	Atomstack X7

## Installation der Luftführungshaube für acht Modelle

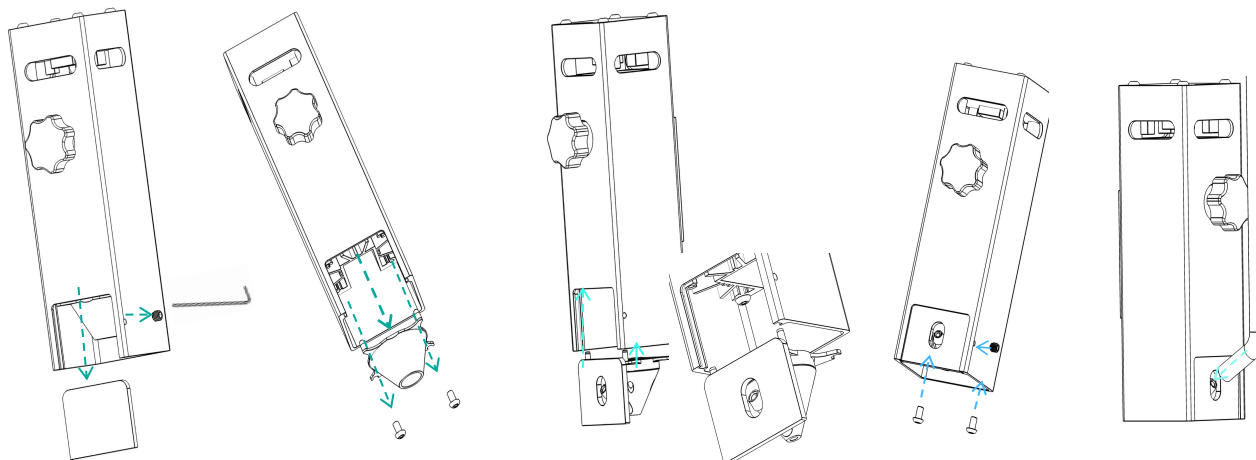

1. Entfernen Sie die Feststellschraube von der rechten Seite des Lasers und entfernen Sie das aktuelle Filterglas oder die Acrylabschirmung.

2. Entfernen Sie die aktuelle Luftführung.

3. Suchen Sie NO.1 und NO.1-2 aus dem Zubehör und installieren Sie sie gleichzeitig wie gezeigt.

4. Befestigen Sie die Luftführung sowie das Filterglas.

5. Setzen Sie das Rohr ein.



Wenn Ihr Modell AtomStack A5 Pro+ oder AtomStack P7 M40 ist, müssen Sie eine der folgenden 2 Kombinationen auswählen, um Ihr Modell zu unterstützen.

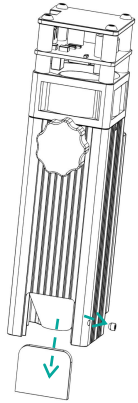

1. Entfernen Sie die Feststellschraube von der rechten Seite des Lasers und entfernen Sie das aktuelle Filterglas oder die Acrylabschirmung.



2. Entfernen Sie die aktuelle Luftführung.

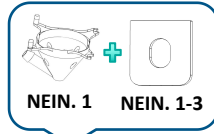

NEIN. 1    NEIN. 1-3

Kombination eins

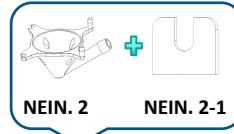

NEIN. 2    NEIN. 2-1

Kombination zwei

Suchen Sie die Kombination, die den Windabweiser enthält, der zu Ihrem Modell passt (Wenn die Unterseite des Glases und der Laser nach der Montage bündig sind, beweist, dass dieser Windabweiser zu Ihrem Modell passt), wählen Sie diese Kombination.

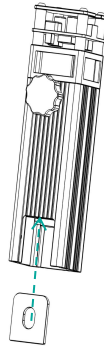

3-1

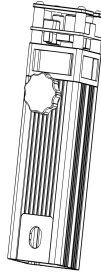

3-2

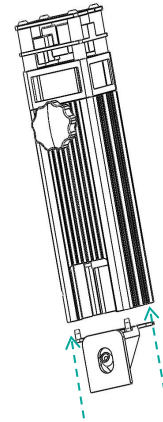

4. Bauen Sie die Kombination passend zu Ihrem Modell ein, montieren Sie gleichzeitig die Luftführung und das Glas.

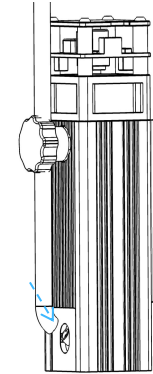

5. Setzen Sie das Rohr ein

# Geräteinstallation und -nutzung

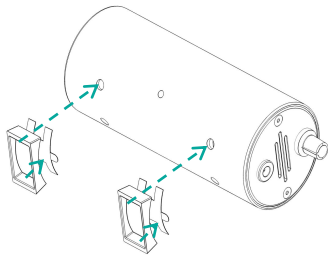

1. Reißen Sie das Klebeschutzpapier von der Silikonunterlage ab, richten Sie die Positionierungsposten auf der Silikonunterlage mit den Befestigungslöchern an der Pumpe aus und kleben Sie die Silikonunterlage auf den Pumpenkörper.

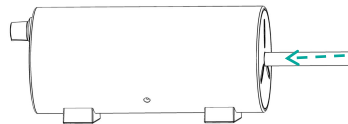

2. Stecken Sie den Luftschlauch in den Luftpumpenanschluss

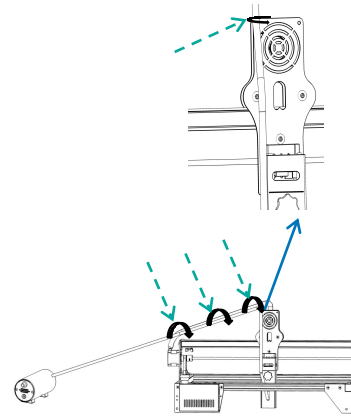

Drehzahlstellknopf (Schalter).

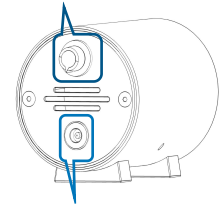

DC-Leistungsschnittstelle

3. Der Schlauch an der Maschine muss mit der Verbindungsleitung durch den Nylonbinder befestigt werden. Achten Sie darauf, es nicht zu fest anzuziehen, um das Rohr zu blockieren.

# Vorsichtsmaßnahmen für die Verwendung

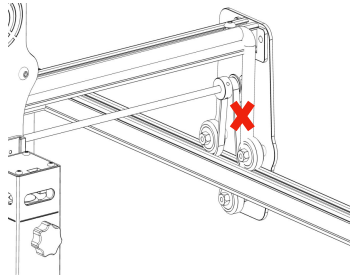

Achten Sie darauf, dass der Schlauch nicht von den Rädern erfasst wird.

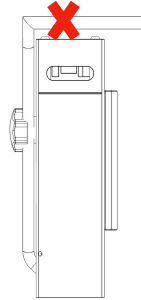

Bitte biegen Sie den Schlauch nicht zu stark, um den Schlauch zu blockieren.

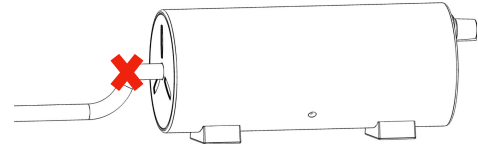

Bitte beachten Sie, dass das Rohr nicht zu stark gebogen werden darf, um das Rohr zu blockieren.



Reinigen Sie nach der Verwendung der Luftführungshaube von Air Assist die Anhaftungen am Luftauslass, um zu verhindern, dass sie sich für längere Zeit ansammeln und die weitere Verwendung beeinträchtigen.



#### Kundendienst:

➤ Für detaillierte Garantiebestimmungen besuchen Sie bitte unsere offizielle Website unter:  
[www.atomstack.com](http://www.atomstack.com)

➤ Für technischen Support und Service senden Sie bitte eine E-Mail: [support@atomstack.com](mailto:support@atomstack.com)

**Hersteller:** Shenzhen AtomStack Technologies Co., Ltd.  
Die Anschrift: 17th Floor, Building 3A, Phase II, Intelligent Park, No. 76, Baohe Avenue, Baolong Street, Longgang Dist., Shenzhen, 518172, China

Scannen Sie den Code, um die Diskussionsgruppe zu betreten.



Scanner ANWENDUNG:  
QR-Code-Leser / Barcode-Scanner oder jede APP mit Scanner.



# ATOMSTACK Air Assist Kit Manuel d'utilisation

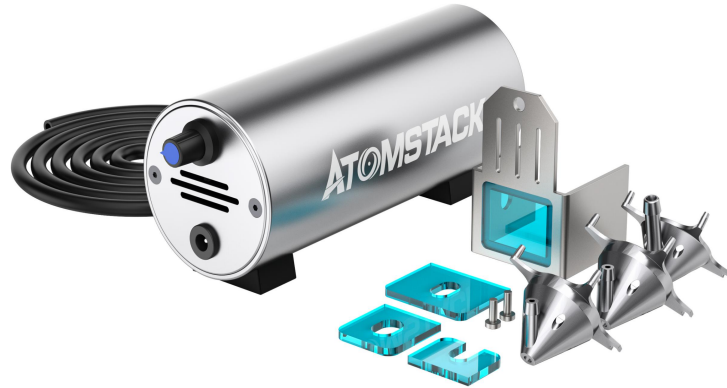

- English
- Deutsche
- Français

Remarque : l'image est fournie à titre indicatif uniquement, le produit réel prévaudra

Pour plus d'informations, veuillez scanner le code QR

















Laser Engraver

# Liste des pièces

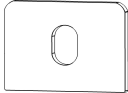

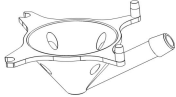
Il s'agit d'une collection de pièces pour différents modèles, chaque modèle n'utilisera pas toutes les pièces de la feuille.

 Pompe	 Adaptateur secteur	 trachée	 Visautotaraudeu ses M3	 Vis de réglage	 Tournevis hexagonal intérieur	 Tournevis cruciforme PH1
 Repose-pied 2 pièces	 NON. 1 2 pièces	 NON. 1-1	 NON. 1-2	 NON. 1-3	 NON. 2	 NON. 2-1

Atomstack A5 10W	Atomstack A5 30W
Atomstack A5 20W	Atomstack A5 Pro

## Installation du capot de guidage d'air pour quatre modèles

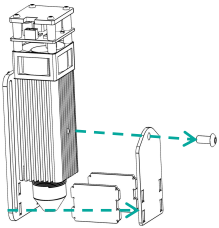

1. Retirez les boucliers acryliques actuels

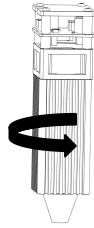

2. Faire pivoter le laser de 180° vers l'arrière

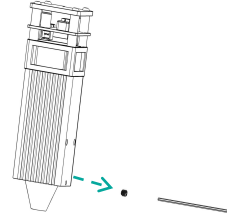

3. Retirez la vis de réglage



4. Faire pivoter le guide d'air actuel dans le sens inverse des aiguilles d'une montre pour le retirer.



L'embouchure du tube du capot de guidage d'air est à gauche

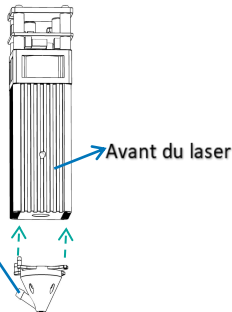

5. Trouvez **NON.1** parmi les accessoires. Installez comme indiqué

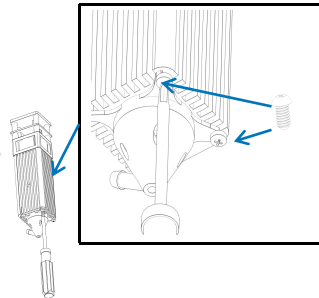

6. Serrez les vis autotaraudeuses avec un tournevis cruciforme PH1

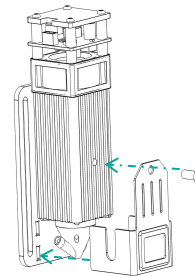

7. Trouvez **NON.1-1** parmi les accessoires et installez-le comme indiqué sur l'image

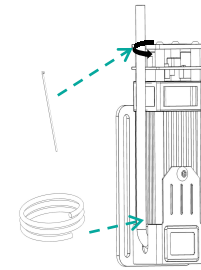

8. Insérez la trachée et fixez-la avec un lien

Atomstack A5 M50 Pro	AtomStack P9 M40	Atomstack X7 Pro	AtomStack P9 M50
AtomStack A10 PRO	Atomstack A5 M50	Atomstack S10 Pro	Atomstack X7

## Installation du capot de guidage d'air pour huit modèles

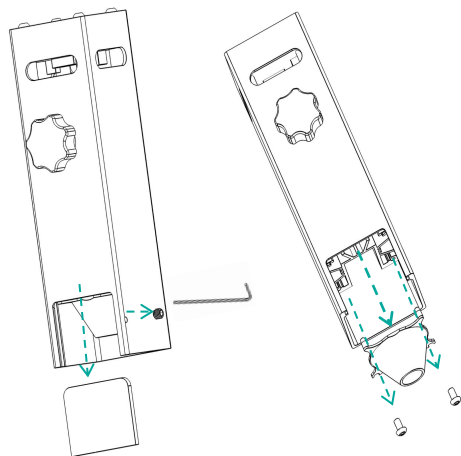

1. Retirez la vis de réglage du côté droit du laser et retirez le verre filtrant actuel ou le bouclier acrylique .

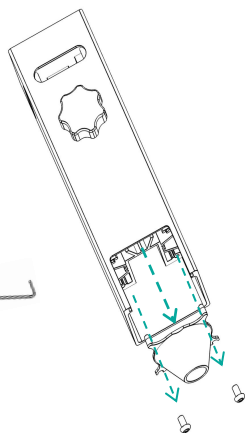

2. Retirer le guide d'air actuel.

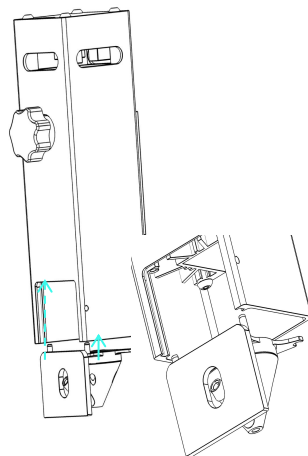

3. Trouvez NO.1 et NO.1-2 parmi les accessoires et installez-les en même temps comme indiqué.

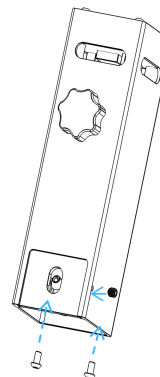

4. Fixez le guide d'air ainsi que le verre filtrant.

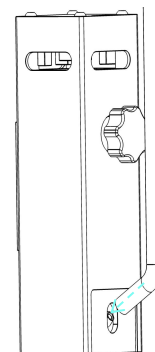

5. Insérez le tuyau.



Si votre modèle est AtomStack A5 Pro+ ou AtomStack P7 M40, vous devez choisir l'une des 2 combinaisons suivantes pour prendre en charge votre modèle.

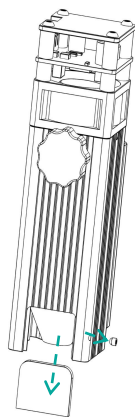

1. Retirez la vis de réglage du côté droit du laser et retirez le verre filtrant actuel ou le bouclier acrylique.



2. Retirer le guide d'air actuel.

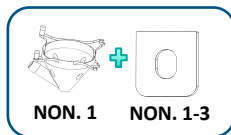

Combinaison un

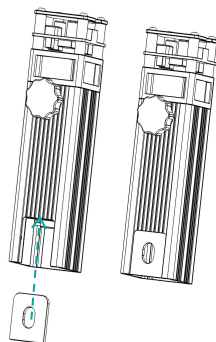

3-1

3-2

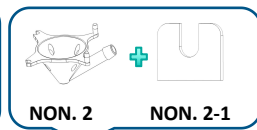

Combinaison deux

localisez la combinaison qui contient le déflecteur de vent correspond à votre modèle (si la surface inférieure du verre et le laser sont alignés après l'assemblage, cela prouve que ce déflecteur de vent correspond à votre modèle), choisissez cette combinaison.

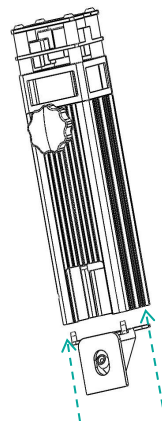

4. Installez la combinaison correspondant à votre modèle, montez le guide d'air et la vitre en même temps.

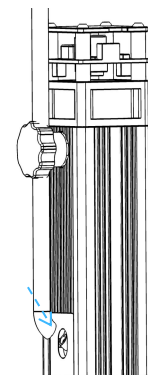

5. Insérez le tuyau.

# Installation et utilisation du matériel

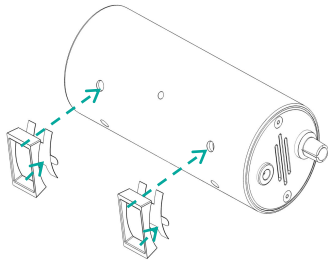

1. Détachez le papier de protection adhésif du tampon en silicone, alignez les poteaux de positionnement sur le tampon en silicone avec les trous de montage sur la pompe et collez le tampon en silicone sur le corps de la pompe.

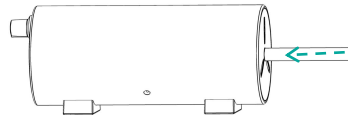

2. Insérez le tube à air dans le port de la pompe à air

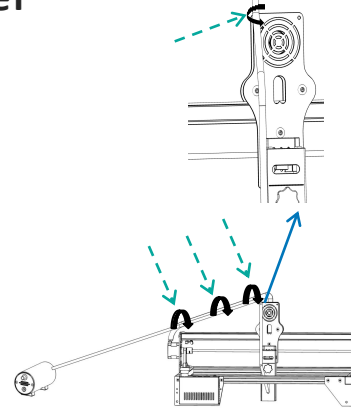

3. Le tube de la machine doit être fixé avec la ligne de connexion par l'attache en nylon. Attention à ne pas le fixer trop serré pour bloquer le tube.

Bouton de réglage de la vitesse (commutateur)

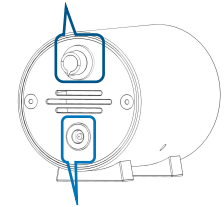

Interface d'alimentation CC

## Précautions d'emploi

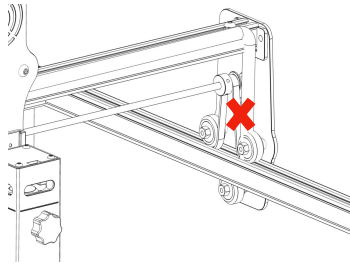

Attention à ne pas coincer le tuyau dans les roues.

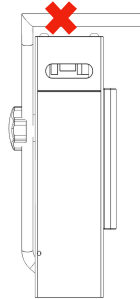

Veillez ne pas trop plier le tube pour bloquer le tube.

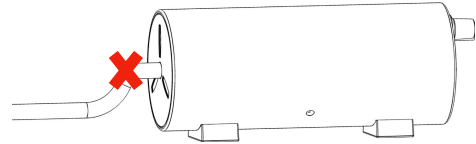

Veillez noter que le tube ne peut pas être trop plié pour bloquer le tube.



Après avoir utilisé le capot de guidage d'air de l'assistance à l'air, veuillez nettoyer les adhérences sur la sortie d'air pour éviter qu'elles ne s'accablent pendant une longue période et n'affectent l'utilisation ultérieure.



#### Service Clients:

➤ Pour une politique de garantie détaillée, veuillez visiter notre site Web officiel à: [www.atomstack.com](http://www.atomstack.com)

➤ Pour le support technique et le service, veuillez envoyer un e-mail: [support@atomstack.com](mailto:support@atomstack.com)

**Fabricant:** Shenzhen AtomStack Technologies Co., Ltd.  
Adresse: 17th Floor, Building 3A, Phase II, Intelligent Park, No. 76, Baohe Avenue, Baolong Street, Longgang Dist., Shenzhen, 518172, China

Scannez le code pour entrer dans le groupe de discussion.



APPLICATIONS du scanner :  
Lecteur de code QR/scanner de code-barres ou toute application avec scanner.