

SAFETY INSTRUCTION

IMPORTANT: NEVER attempt any work without shutting off the electricity.

- Always turn off power at fuse box prior to installation to prevent electrical shock.
- Intended for indoor use. Dry and damp locations.
- For installation and serviced by a qualified, licensed electrician.
- Install in accordance with national electric code, and local regulations.
- Consult with local inspector to assure compliance.
- Do not submerge, or install within 5 feet of a swimming pool.
- Only install with a WAC UL listed Class 2 24VDC LED power supply.
- Do not connect the tape directly to high voltage power
- Do not exceed maximum run recommended for each tape series
- Do not connect the tape with 24VAC output Electronics transformer.

CAUTION

- Read all instructions before installing.
- Handle product with care.
- Do not modify or disassemble product beyond instructions or warranty will be void.
- Cutting anywhere other than the cut point will result in a damage to the tape light
- Failure to follow safety warnings, and installation instruction will void the warranty
- 3-wires are needed for proper operation of InvisiLED® Dim-To-Warm
- Tape light will begin to flash if maximum rated output power from WAC 24VDC Dim-To-Warm power supply is overloaded.



Avoid contact with sharp objects



Install on stable clean, dry surface

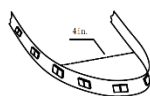

Do not bend the tape light to a diameter less than 4 inches

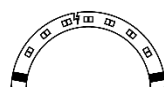

Do not bend the tape light on a horizontal plane



Do not fold or twist LED Tape

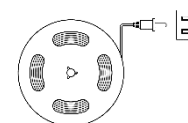

Do not power the LED tape while attached to the spool or tightly coiled

WIRING AND INSTALLATION:

1. Turn Power off at circuit breaker

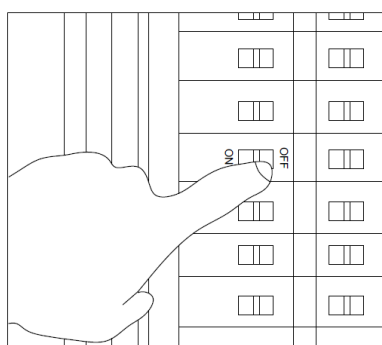

2. Mounting Enclosed 24VDC Dim-To-Warm class 2 output remote power supply at desired location. Measured a distance between power supply to the beginning of the tape run and make sure that it is under 100ft. The allowed maximum distance of wires between the output of power supply to the beginning of tape is 100 ft. The minimum output gauge wire of power supply is 20 AWG.

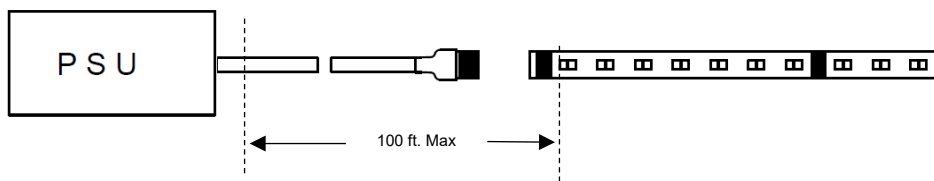

To extend the cable length (if needed), In Wall Rated Joiner Cable (T24-IC) and Joiner Cable Extender (T24-FF-WT) can be used to join between sections as shown below:

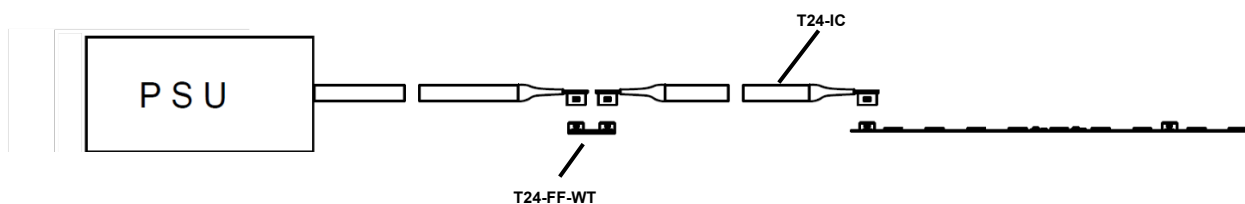

To extend the cable length between power supply cable or a wiring box to a tape section, (if needed), In Wall Rated Extension Cable (T24-EX3) can be used to join between sections by soldering as shown below:

Wire Color		
Dim-To-Warm Power Supply Output	T24-EX3 Cable	Tape marking
RED	RED	+24VDC
BLACK	BLACK	-3000K/3500K
BLUE	WHITE	-1800K

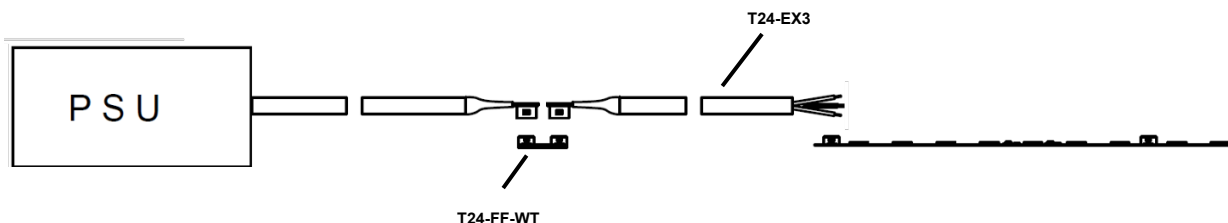

3. Measure the desired length of tape light and round it off to the nearest 4-inch interval. Determine necessary quantities of other accessories and power supply need for each run. Do not exceed maximum run recommended for each tape series

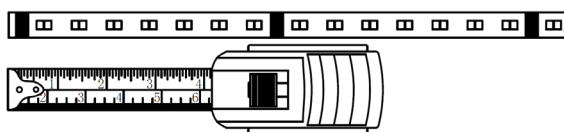

4. If necessary, cut tape light to desired length at line indicated with scissors icon. The tape allows for a cut every 4-inch interval. The cut line is shown on both sides of connector.

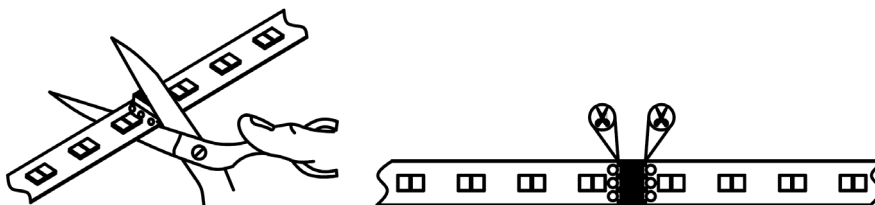

- Mount Tape Light: Clean surface before mounting. Peel off 3M adhesive backing cover off as strip is installed, pressing firmly to mounting surface in increments.

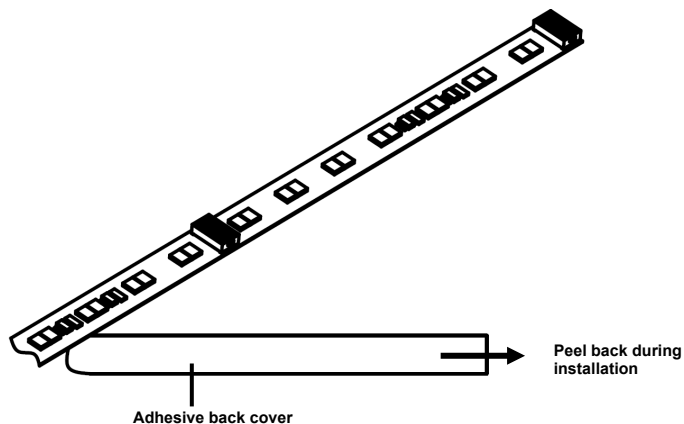

- Joining between tapes:
 Joining tape together (If necessary), the following accessories can be used to join between tapes section depending on your application:

Tape to Tape Connector (T24-MM-WT)



Another way to join between tape is to use soldering method. Before soldering, making sure to scrap off the polyurethane coating on the surface of the copper pad using a sharp cutter or knife blade.

Tape to Tape T Connector (T24-TI-WT)

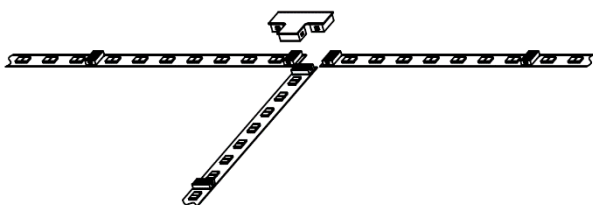

Tape to Tape X Connector (T24-XI-WT)

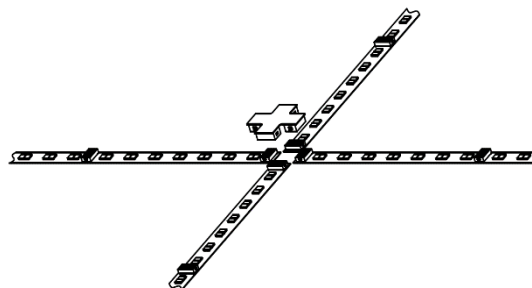

Tape to Tape L Connector (T24-LI-WT)

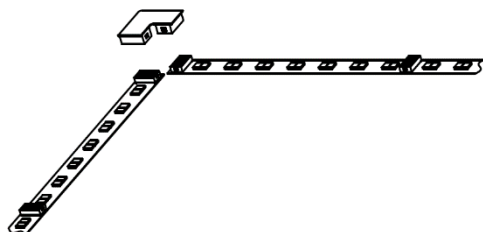

Flex Tape to Tape Y Connector
 (T24-Y-WT, T24-Y-BK)

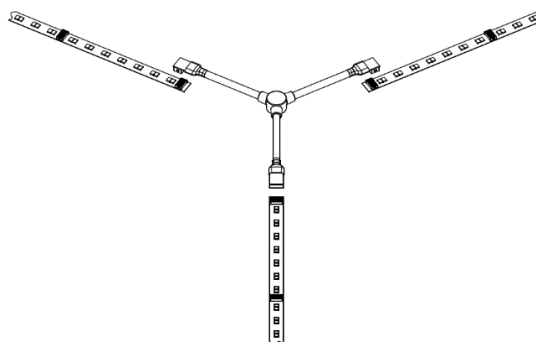

Flex Tape to Tape X Connector (T24-X-WT, T24-X-BK)

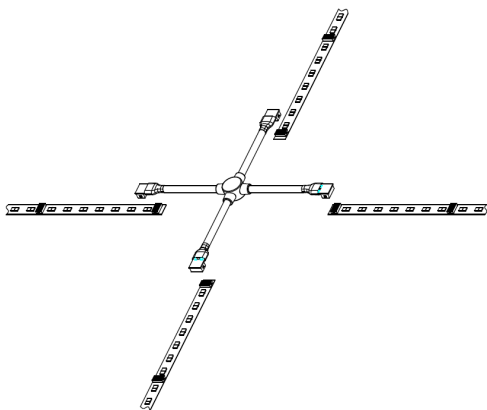

7. Connect electrical power feed connector to any connector on the tape or accessories. There is no polarity. Power feed and connectivity can be done with all directions.

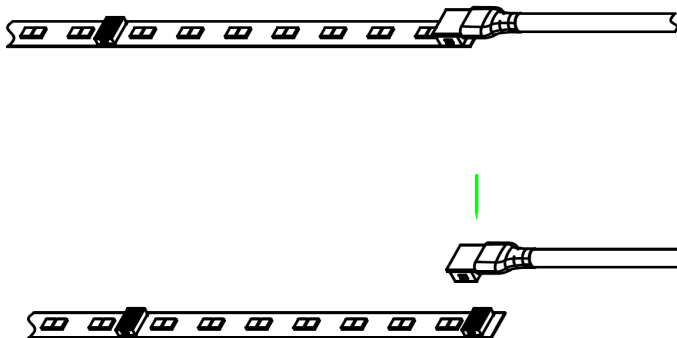

Hard Wire:

- Enclosed 24VDC Dim-To-Warm class 2 output remote power supply must be installed away from any heat sources and it must be accessible for service.
 - Enclosed 24VDC Dim-To-Warm class 2 output remote power supply is UL listed.
 - The power supply box has a separate line voltage, and low voltage wiring compartments.
 - Trade size knock out are provided on both compartments. Connect building wires to the same color power supply wires with wire nuts or UL certified electrical connector.
 - Building ground wire may be green or uninsulated, and attaches to green wire from power supply box.
 - Additional power feeds and wiring components are available.
8. Slide the switch position to set low end desirable color temperature (CCT) on the power supply
 - Low end CCT can be adjusted and selected among 1800K, 1900K, 2000K, 2100K, 2200K.

SYSTEM DIAGRAM:

ON/OFF Switch System

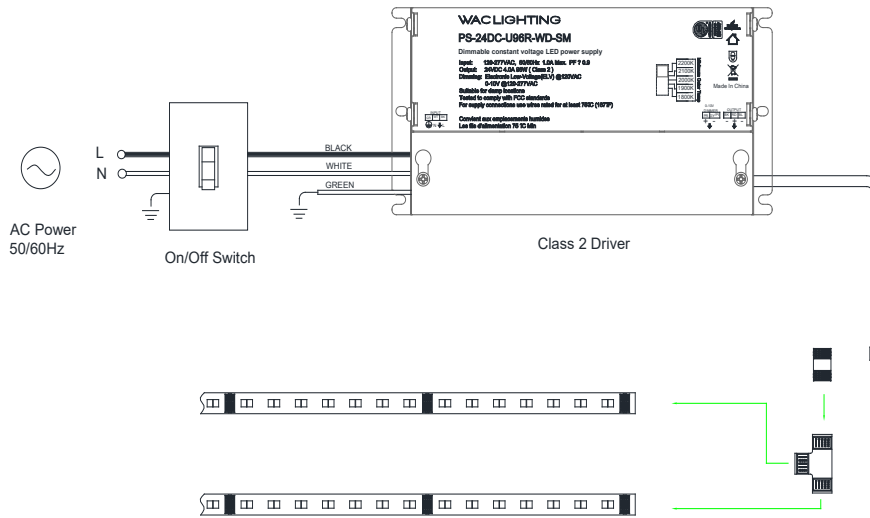

ELV Dimmer Control System

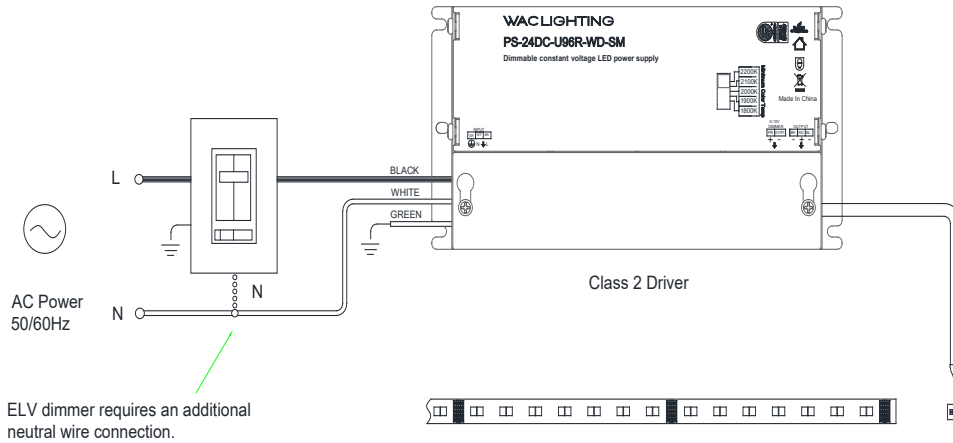

0-10V Dimmer Control System

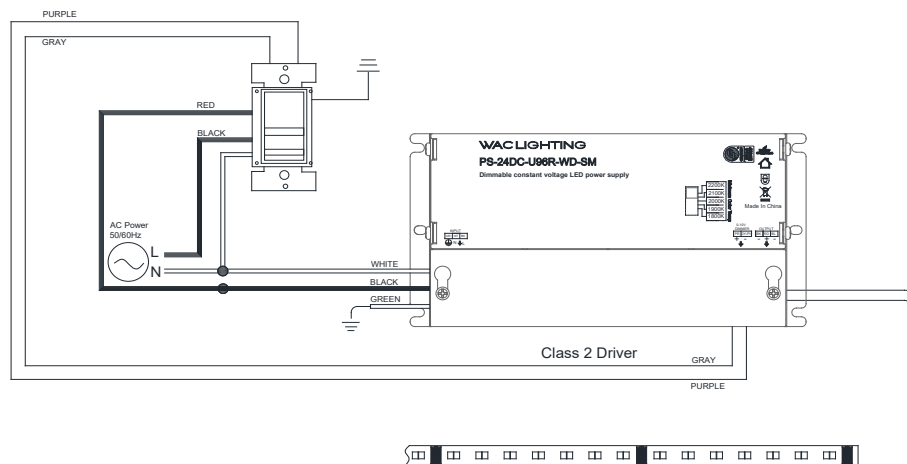

CAUTION: WAC Dim-To-Warm Tape light may not be able to dim with other power supply brands. Using only designated power supply to achieve best dimming result.