

## ASSEMBLY INSTRUCTIONS

### McClain 42" Hardwired Picture Light Item # SP 2605

**WE RECOMMEND INSTALLATION OF THIS LIGHTING FIXTURE BE DONE BY A LICENSED ELECTRICIAN.**

**WARNING \*\*\* SWITCH OFF THE MAIN ELECTRICAL SUPPLY FROM THE MAIN FUSE BOX/CIRCUIT BREAKER BEFORE INSTALLATION.**

**INSPECT ITEM CAREFULLY BEFORE ATTEMPTING TO INSTALL. IF THERE IS ANY DAMAGE OR OBVIOUS DEFECT, DO NOT INSTALL.**

**ITEM MAY NOT BE RETURNED ONCE IT HAS BEEN INSTALLED.**

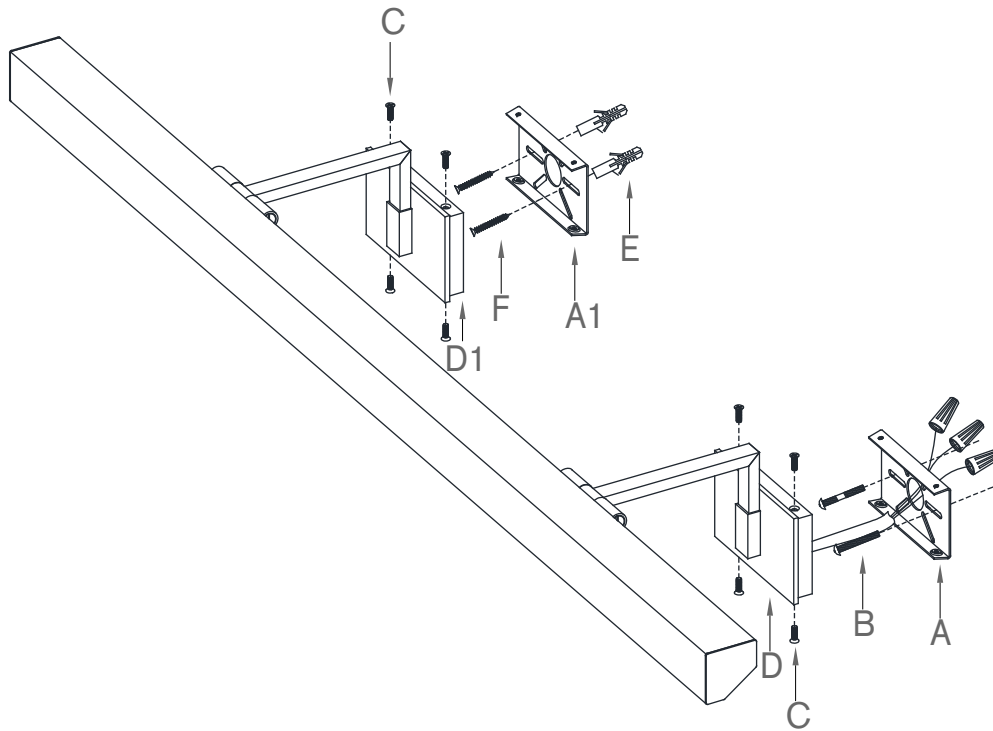

1. Carefully remove all parts from the carton.
2. Remove both mounting plates (A) & (A1) from base of light fixtures (D) & (D1) by removing base screws (C) in counter-clockwise direction.
3. Place mounting plate (A) to wall outlet box and secure with mounting screws (B) provided.
4. Place fixture base (D) on the affixed mounting plate (A), mark outer line for fixture base (D1), make sure it is horizontal to the affixed mounting plate (A). Remove the whole light fixture.
5. Place mounting plate (A1) to the marked area, mark center points for the mounting slots for mounting plate (A1) on the wall. Remove mounting plate (A1).
6. Drill small holes on the marked location, the holes should be big enough to accommodate with plastic anchors (E). Push plastic anchors (E) into the holes.
7. Affix mounting plate (A1) to the wall, inserting mounting screws (F) to plastic anchors (E) to secure mounting plate (A1) to the wall.
8. Attach ground (green) wire to ground wire from wall outlet box (usually green or copper in color), fasten together with a plastic wire connector. Tightly wrap the wire connector with electrical tape, so the end of the connector is sealed. IT IS IMPERATIVE THAT THE OUTLET BOX IN YOUR HOME BE PROPERLY GROUNDED.
9. Connect neutral (white) fixture wire coming from fixture base to neutral (usually white) outlet wire. Fasten both wires together with a plastic wire connector and tightly wrap the wire connector with electrical tape.
10. Repeat the procedure with the hot (black) wires. Always make sure that no wire strands are left outside the connectors. DO NOT REVERSE THE HOT AND NEUTRAL CONNECTIONS OTHERWISE SAFETY WILL BE COMPROMISED.
11. Attach fixture bases (D) & (D1) to the affixed mounting plates (A) & (A1) and secure with base screws (C).
12. Insert light bulbs into sockets.
13. Restore power and test fixture. Installation is complete.

\*\*\* Clean with a dry, soft cloth only. Use no harsh abrasives or chemical agents.