

# ASSEMBLY INSTRUCTIONS

## Dot 16" Caged Flush Mount

Item # PB 4004

**WE RECOMMEND INSTALLATION OF THIS LIGHTING FIXTURE BE DONE BY A LICENSED ELECTRICIAN.**

**WARNING\*\*\*SWITCH OFF THE MAIN ELECTRICAL SUPPLY FROM THE MAIN FUSE BOX/CIRCUIT BREAKER BEFORE INSTALLATION.**

**INSPECT ITEM CAREFULLY BEFORE ATTEMPTING TO INSTALL. IF THERE IS ANY DAMAGE OR OBVIOUS DEFECT. DO NOT INSTALL.**

**ITEM MAY NOT BE RETURNED ONCE IT HAS BEEN INSTALLED.**

**NOTE: CAREFULLY UNPACK EACH PIECE IN TOP LAYER OF PACKING PRIOR TO REMOVING. RETAIN ALL PACKING MATERIAL UNTIL INSPECTION AND INSTALLATION ARE FINAL.**

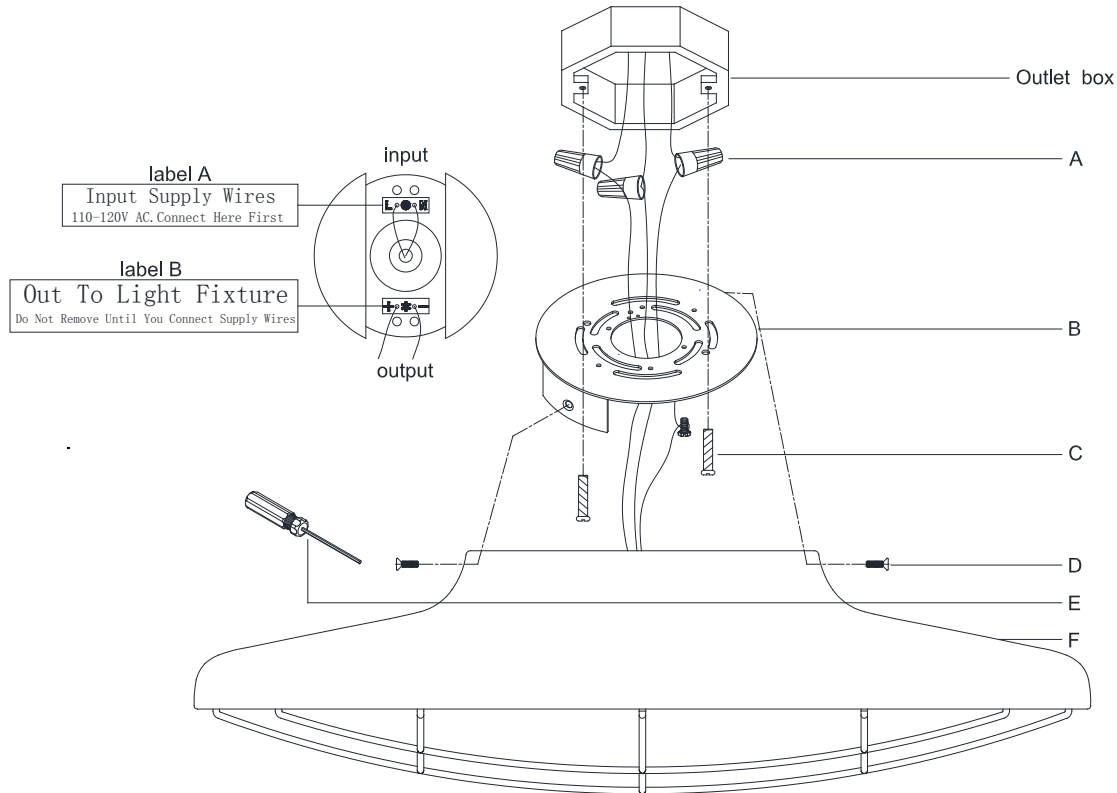

1. Carefully remove all parts from the box.
2. Remove the mounting plate (B) from the fixture body (F) by loosening side screws (D) with using the wrench (E).
3. Affix mounting plate (B) onto the outlet box and secure with mounting screws (C).
4. Tear off label A on the driver. Insert the jump Hot wire (smooth edge, markings) into hole (marked "L") on driver, then insert the jump Neutral wire (ribbed, no markings) into hole (marked "N") on driver.
5. Connect the jump Neutral wire (ribbed, no markings) with the neutral wire from the outlet box using wire nut (A).
6. Connect the jump Hot wire (smooth edge, markings) with the hot wire from the outlet box using wire nut (A).  
DO NOT REVERSE THE HOT AND NEUTRAL CONNECTIONS OR SAFETY WILL BE COMPROMISED.
7. Connect ground wire from the fixture (bare copper) to ground wire from the outlet box (usually green or copper in color).  
IT IS IMPERATIVE THAT THIS FIXTURE BE GROUNDED.
8. Attach fixture body (F) onto the mounting plate (B) and secure with side screws (D) by using the wrench (E).
9. Installation is complete, turn on power at fuse or circuit breaker.

\*\*\*Clean with a dry, soft cloth only. Use no harsh abrasives or chemical agents.