

ASSEMBLY INSTRUCTIONS

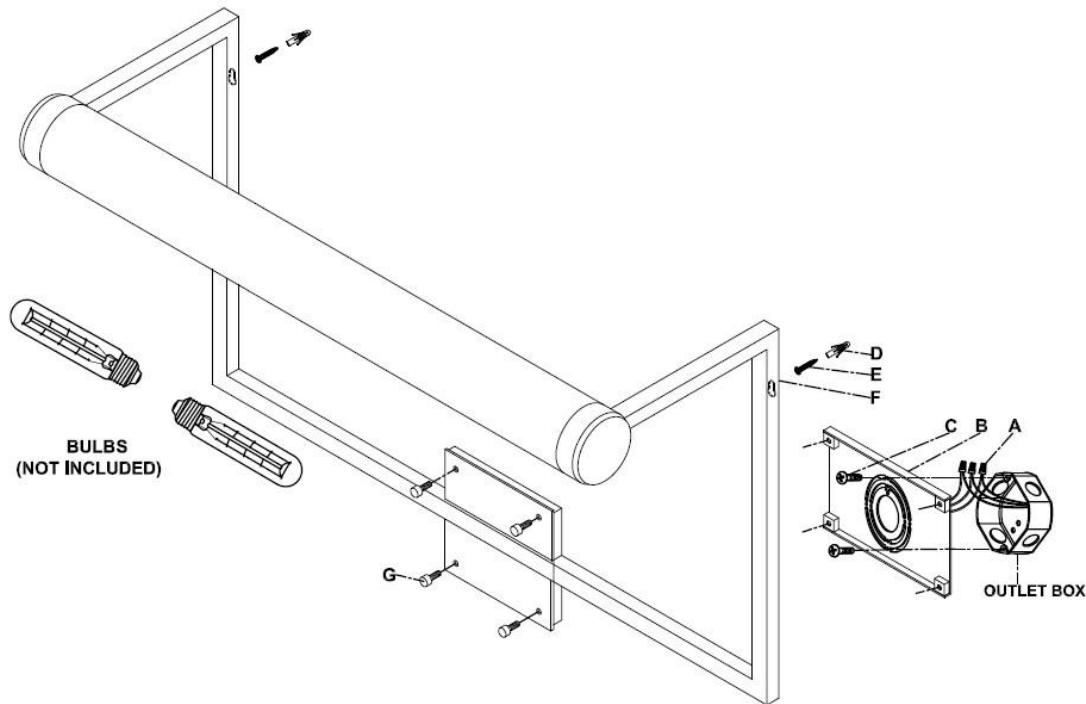

Cosmopolitan 18" Picture Light

Item #TOB2621

WE RECOMMEND INSTALLATION OF THIS LIGHTING FIXTURE BE DONE BY A LICENSED ELECTRICIAN.

WARNING***SWITCH OFF THE MAIN ELECTRICAL SUPPLY FROM THE MAIN FUSE BOX/ CIRCUIT BREAKER BEFORE INSTALLATION.

INSPECT ITEM CAREFULLY BEFORE ATTEMPTING TO INSTALL. IF THERE IS ANY DAMAGE OR OBVIOUS DEFECT. DO NOT INSTALL.

ITEM MAY NOT BE RETURNED ONCE IT HAS BEEN INSTALLED.

NOTE: CAREFULLY UNPACK EACH PIECE IN TOP LAYER OF PACKING PRIOR TO REMOVING. RETAIN ALL PACKING MATERIAL UNTIL INSPECTION AND INSTALLATION ARE FINAL.

1. Carefully remove all parts from the box.
2. Guide wiring from wall outlet through centre hole in mounting plate (B).
3. Affix mounting plate (B) to wall outlet box with mounting screws (C).
4. Measure the distance of the key holes(F) on the lamp body, drill two holes with same distance on the wall, insert the plastic anchors to the holes, thread the screw (E) to the anchors.
5. Connect the hot wire (BLACK) from the fixture to the hot wire from the outlet box (usually BLACK). Fasten them together with a plastic wire connector (A) provided and wrap the connection with electrical tape.
6. Connect the neutral wire (WHITE) from the fixture to the wire from the outlet box(usually WHITE). Fasten them together with a plastic wire connector (A) provided and wrap the connection with electrical tape.
DO NOT REVERSE THE HOT AND NEUTRAL CONNECTIONS OR SAFETY WILL BE COMPROMISED.
7. Connect ground wire from the fixture (bare copper) to ground wire from the outlet box (usually green or copper in color).
IT IS IMPERATIVE THAT THIS FIXTURE BE GROUNDED.
8. Attach lamp body to the screws (E) and affixed mounting plate (B), secure with fixing screw (G).
9. Install bulb (not included) to the socket.
10. Installation is complete, turn on power at fuse or circuit breaker.

***Clean with a dry, soft cloth only. Use no harsh abrasives or chemical agents.

