

# ENTRA™ CL 3" LED

## ADJUSTABLE, FIXED, AND WALL WASH DOWNLIGHTS

The ENTRA CL 3" Adjustable, Fixed, and Wall Wash Downlights offer a cost-effective alternative for residential, multi-family, and hospitality applications. Engineered for high performance and reliability, ENTRA CL 3" is easily configurable with a feature set that offers flexibility without an overwhelming list of options. The ENTRA CL 3" Adjustable, Fixed, and Wall Wash Downlights offer LED options with Static White and Warm Dim.

- SDCM: 2-step static white and warm dim
- Hot aiming (0-35° tilt + 360° rotation)
- Interchangeable optics: 20°, 30°, 40°, 60°
- Flanged/flangeless die-cast trims
- Available in IC Airtight, Chicago Plenum, and Fire-Rated



ADJUSTABLE



FIXED



WALL WASH

### LUMEN MULTIPLIER (CRI/CCT)

CCT	90 CRI MULTIPLIER
2700K	0.95
3000K	1.00
3500K	1.05

Lumen output will vary by CCT and CRI. See photometric charts for output information.

### SPECIFICATIONS

	ADJUSTABLE & FIXED				WALL WASH			
	STATIC WHITE		WARM DIM		STATIC WHITE		WARM DIM	
DELIVERED LUMENS	Lumens	Efficacy	Lumens	Efficacy	Lumens	Efficacy	Lumens	Efficacy
12W	1100	94	800	67	730	61	530	44
15W	1300	85	N/A	N/A	925	62	N/A	N/A
CRI	90+							
CCT	2700K, 3000K, or 3500K		3000K - 1800K		2700K, 3000K, or 3500K		3000K - 1800K	
COLOR CONSISTENCY	2-step							
VOLTAGE	120V or 277V							
DIMMING <sup>1</sup>	Standard reverse-phase, forward-phase, TRIAC, and 0-10V dimming down to 1%							
POWER SUPPLY	Constant current driver with +.9 power factor and +80% efficiency							
OPTICS	Field changeable: Includes 40° optic. 20°, 30°, and 60° optics can be ordered separately.				Asymmetric wall wash			
ADJUSTABILITY	Adjustable module: 35° tilt, 360° rotation				N/A			
CEILING APPEARANCE	Flanged and flangeless up to 2" ceiling thickness. Note: Tilt may be restricted in thicker ceilings							
CEILING APERTURE	3-3/4" ceiling cutout							
HOUSING	Fire-Rated, IC Airtight, Chicago Plenum. IC suitable up to R60 spray foam insulation							
CONSTRUCTION	Housing: Galvanized Steel Trims and Reflectors: Die-Cast Aluminum							
FINISH	Reflector: White, Black, Champagne, or Satin Silver (low-glare) Flange: White or Black Select finish options for reflector and flange separately							
GENERAL LISTINGS	ETL Listed. Fixed and Wall Wash Wet Listed. Adjustable Damp Location Listed.							
CALIFORNIA TITLE 24	Registered CEC Appliance Database. Can be used to comply with CEC 2019 Title 24 Part 6 (JA8-2016, JA8-2019) (for 90 CRI versions).							
L70	50,000 hours min							
WARRANTY <sup>2</sup>	5 years							

Data in chart reflects 3000K/90CRI values unless noted.

Ordering grids available on page 2.

<sup>1</sup>See [visualcomfort.com](http://visualcomfort.com) for dimmer compatibility.

<sup>2</sup>Visit [visualcomfort.com](http://visualcomfort.com) for specific warranty limitations and details.

# ENTRA™ CL 3" LED

## ADJUSTABLE, FIXED, AND WALL WASH DOWNLIGHTS

### ORDERING GRIDS

#### HOUSING

PRODUCT	CEILING APPEARANCE	OUTPUT	HOUSING RATING
<b>ENCL3R</b> ENTRA CL 3" ROUND	<b>L</b> FLANGELESS	<b>-L12</b> 12W (1100 LMS)	<b>I</b> IC AIRTIGHT
<b>ENCL3S</b> ENTRA CL 3" SQUARE	<b>F</b> FLANGED	<b>-L15</b> 15W (1300 LMS) <sup>1</sup>	<b>C</b> CHICAGO PLENUM
			<b>F</b> FIRE-RATED, IC AIRTIGHT <sup>2,3</sup>

Includes an LED driver with universal input 120V-277V, dimmable by reverse-phase, forward -phase, TRIAC, and 0-10V controls. 277V is only compatible with 0-10V dimming. See dimmer compatibility chart.

Trims are required and must be ordered separately.

<sup>1</sup>L15 - Output not available with WD31 warm dim.

<sup>2</sup>F- Certified to ASTM E119, UL 263, and CAN/ULC-S101. Fire Rating of 1 and 2 hours, respectively.

<sup>3</sup>F- Fire-Rated, IC Airtight is not available in Adjustable or Wall Wash.

#### TRIM/LIGHT MODULE

PRODUCT	CEILING APPEARANCE	FUNCTION	CRI/CCT	REFLECTOR FINISH	FLANGE FINISH
<b>ENCL3R</b> ENTRA CL 3" ROUND	<b>L</b> FLANGELESS	<b>A</b> ADJUSTABLE <sup>1</sup>	<b>-927</b> 90 CRI, 2700K, 2-STEP	<b>W</b> WHITE	FLANGELESS ONLY
<b>ENCL3S</b> ENTRA CL 3" SQUARE	<b>F</b> FLANGED	<b>D</b> DOWNLIGHT	<b>-930</b> 90 CRI, 3000K, 2-STEP	<b>B</b> BLACK	(LEAVE BLANK)
		<b>W</b> WALL WASH <sup>1</sup>	<b>-935</b> 90 CRI, 3500K, 2-STEP	<b>S</b> SATIN SILVER	<b>-W</b> WHITE
			<b>-WD31</b> 90 CRI, 3000K-1800K, WARM DIM, 2-STEP <sup>2,3</sup>	<b>C</b> CHAMPAGNE	<b>-B</b> BLACK

Includes 40° optic. 20°, 30° and 60° optics can be ordered separately.

<sup>1</sup>F- Fire-Rated, IC Airtight is not available in Adjustable or Wall Wash.

<sup>2</sup>WD31 - Warm dim not available with L15 output.

<sup>3</sup>WD31 - Warm dim includes a sandblasted lens; no additional lenses/louvers can be added.

#### REPLACEMENT OPTICS

PRODUCT	BEAM SPREAD
<b>353LEDGATOPT</b>	<b>20</b> 20°
	<b>30</b> 30°
	<b>40</b> 40°
	<b>60</b> 60°

#### 353LEDGATOPT

#### LENSES/LOUVERS

PRODUCT <sup>1</sup>	TYPE
<b>MOC</b>	<b>GG</b> PLAIN GLASS
	<b>SF</b> SOFT FOCUS
	<b>SB</b> SANDBLASTED
	<b>LL</b> LINEAR SPREAD
	<b>EC</b> EGGCRATE LOUVER

#### MOC

<sup>1</sup>Lenses/louvers mounted to lamp assembly only (max 1).

#### PLASTER PLATES

PRODUCT	
<b>AA6268</b>	ROUND DIE-CAST PLASTER PLATE
<b>AA7162</b>	SQUARE DIE-CAST PLASTER PLATE

Plaster plates are used to convert flanged housings into flangeless housings.

Ships standard with flangeless housings.



# ENTRA™ CL 3" LED

ADJUSTABLE, FIXED, AND WALL WASH DOWNLIGHTS

TRIMS

ADJUSTABLE

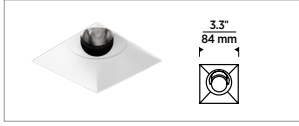

SQUARE FLANGELESS

FIXED

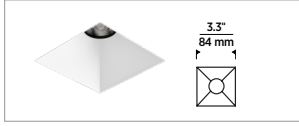

SQUARE FLANGELESS

WALL WASH

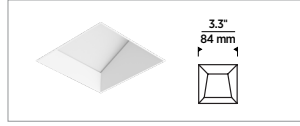

SQUARE FLANGELESS

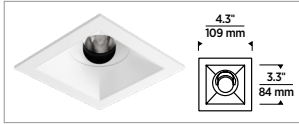

SQUARE FLANGED

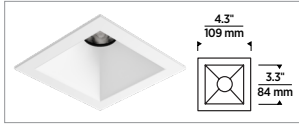

SQUARE FLANGED

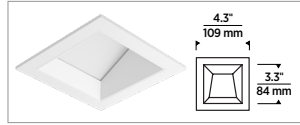

SQUARE FLANGED

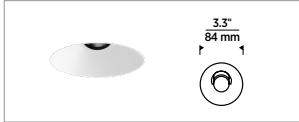

ROUND FLANGELESS

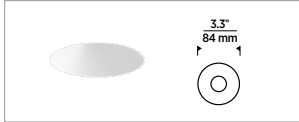

ROUND FLANGELESS

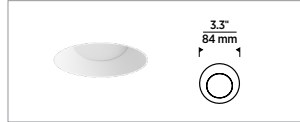

ROUND FLANGELESS

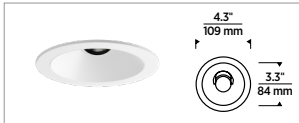

ROUND FLANGED

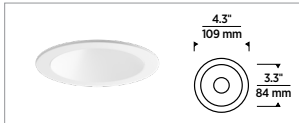

ROUND FLANGED

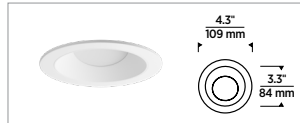

ROUND FLANGED

FINISH OPTIONS (ALL SHOWN AS ROUND, FLANGED, FIXED. REFLECTORS ARE DIE CAST.)

WHITE TRIM



WHITE TRIM, BLACK REFLECTOR

BLACK TRIM

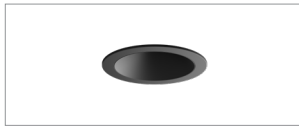

BLACK TRIM, BLACK REFLECTOR



WHITE TRIM, WHITE REFLECTOR

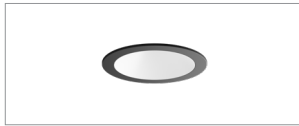

BLACK TRIM, WHITE REFLECTOR



WHITE TRIM, CHAMPAGNE REFLECTOR



BLACK TRIM, CHAMPAGNE REFLECTOR



WHITE TRIM, SILVER REFLECTOR



BLACK TRIM, SILVER REFLECTOR



# ENTRA™ CL 3" LED

ADJUSTABLE, FIXED, AND WALL WASH DOWNLIGHTS

## HOUSING

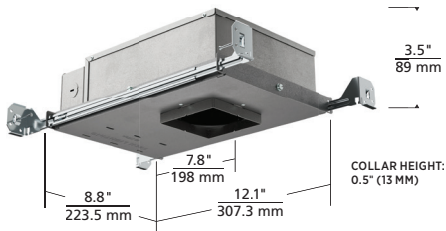

IC AIRTIGHT/FIRE-RATED/  
CHICAGO PLENUM

## PLASTER PLATES

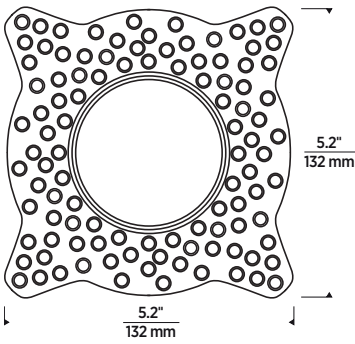

ROUND PLASTIC  
(INCLUDED FOR FLANGELESS INSTALLATION)

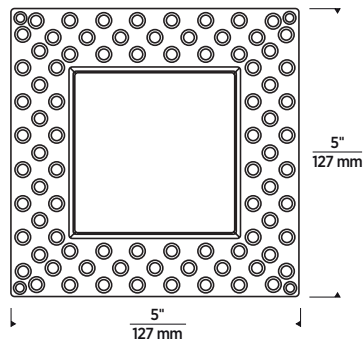

SQUARE PLASTIC  
(INCLUDED FOR FLANGELESS INSTALLATION)

# ENTRA™ CL 3" LED

## ADJUSTABLE, FIXED, AND WALL WASH DOWNLIGHTS

### PHOTOMETRICS

Description: 3" LED Module  
20° Beam - 0° Tilt, 3000K

Model: Entra CL 3" Fixed  
20° 12W Output

Input Power (Watts): 11.69  
Input Power Factor: 0.98

Absolute Luminous Flux (Lumens): 964  
Lumen Efficacy (Lumens per Watt): 82.4

Description: 3" LED Module  
30° Beam - 0° Tilt, 3000K

Model: Entra CL 3" Fixed  
30° 12W Output

Input Power (Watts): 11.7  
Input Power Factor: 0.98

Absolute Luminous Flux (Lumens): 1097  
Lumen Efficacy (Lumens per Watt): 93.8

Description: 3" LED Module  
40° Beam - 0° Tilt, 3000K

Model: Entra CL 3" Fixed  
40° 12W Output

Input Power (Watts): 11.7  
Input Power Factor: 0.98

Absolute Luminous Flux (Lumens): 1036  
Lumen Efficacy (Lumens per Watt): 88.6

Output difference between CCTs - 5%, CRIs - 15%.

ANGLE	0°	45°	90°
0°	2779	2779	2779
5°	2577	2502	2535
10°	1980	1892	1932
15°	1333	1260	1302
20°	857	805	838
25°	534	494	518
30°	316	287	305
35°	180	166	172
40°	72	62	68
45°	31	28	30
50°	9	8	8
55°	6	6	6
60°	4	4	4
65°	3	3	3
70°	2	2	2
75°	1	1	1
80°	1	1	1
85°	0	0	0
90°	0	0	0

ANGLE	0°	45°	90°
0°	2809	2809	2809
5°	2694	2633	2678
10°	2285	2208	2291
15°	1656	1578	1675
20°	1042	981	1063
25°	580	536	591
30°	305	272	301
35°	157	136	149
40°	62	52	61
45°	26	20	22
50°	7	6	7
55°	4	4	4
60°	3	3	3
65°	2	2	2
70°	2	2	2
75°	1	1	1
80°	1	1	1
85°	0	0	0
90°	0	0	0

ANGLE	0°	45°	90°
0°	1806	1806	1806
5°	1765	1738	1753
10°	1627	1603	1624
15°	1395	1370	1400
20°	1078	1046	1074
25°	734	681	711
30°	423	383	401
35°	229	196	207
40°	96	80	83
45°	36	29	30
50°	11	9	9
55°	5	4	5
60°	3	3	3
65°	2	2	2
70°	2	2	2
75°	1	1	1
80°	1	1	1
85°	0	0	0
90°	0	0	0

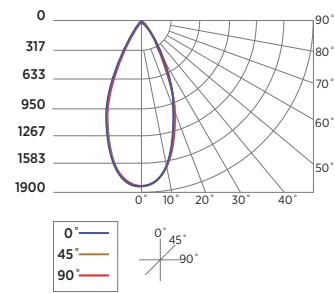
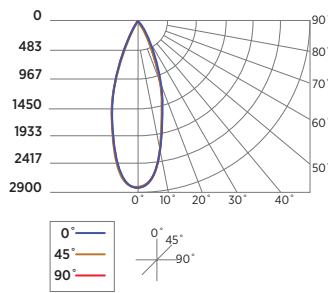
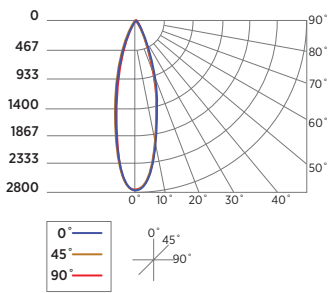
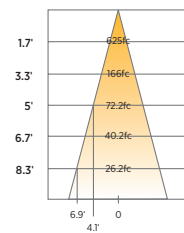
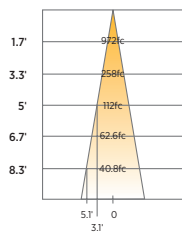
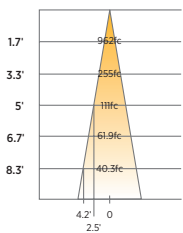

# ENTRA™ CL 3" LED

## ADJUSTABLE, FIXED, AND WALL WASH DOWNLIGHTS

### PHOTOMETRICS

Description: 3" LED Module  
60° Beam - 0° Tilt, 3000K

Model: Entra CL 3" Fixed  
60° 12W Output

Input Power (Watts): 11.7  
Input Power Factor: 0.98

Absolute Luminous Flux (Lumens): 1101  
Lumen Efficacy (Lumens per Watt): 94.2

Output difference between CCTs - 5%, CRIs - 15%.

Description: 3" LED Module  
Wall Wash, 3000K

Model: Entra CL 3" Wall Wash  
12W Output

Input Power (Watts): 11.7  
Input Power Factor: 0.99

Absolute Luminous Flux (Lumens): 730  
Lumen Efficacy (Lumens per Watt): 62

Output difference between CCTs - 5%, CRIs - 15%.

ANGLE	0°	45°	90°
0°	1144	1144	1144
5°	1137	1125	1124
10°	1093	1078	1080
15°	1011	996	1006
20°	900	879	902
25°	763	738	755
30°	605	574	585
35°	445	406	418
40°	287	251	263
45°	149	130	136
50°	81	71	71
55°	11	15	20
60°	8	8	8
65°	6	6	6
70°	5	4	5
75°	3	3	3
80°	2	2	2
85°	1	1	1
90°	0	0	0

ANGLE	0°	45°	90°
0°	311	311	311
5°	297	302	311
10°	285	292	309
15°	268	278	302
20°	250	262	291
25°	230	243	277
30°	211	224	260
35°	190	203	239
40°	168	181	212
45°	144	157	180
50°	116	130	147
55°	87	102	115
60°	59	72	82
65°	35	44	52
70°	21	22	28
75°	14	12	12
80°	9	7	5
85°	4	3	2
90°	0	0	0

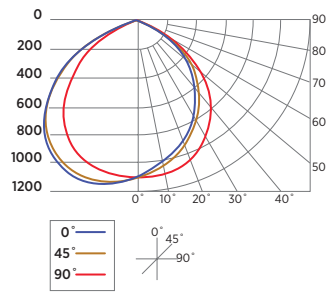
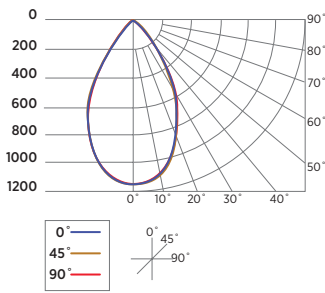
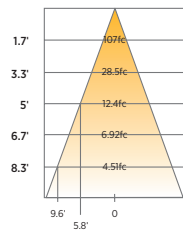
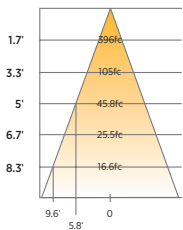

# ENTRA™ CL 3" LED

ADJUSTABLE, FIXED, AND WALL WASH DOWNLIGHTS

## PROJECT INFORMATION

---

## JOB NAME AND INFORMATION

---

---

---

---

---

---

---

---

---

---

## FIXTURE TYPE AND QUANTITY

---

---

---

---

---

---

---

---

---

---

## NOTES

---

---

---

---

---

---

---

---

---

---

---

---

---

---

---

---

---

---

---

---

---

---

---

---