

DIADEMA

Design Romani Saccani Architetti Associati

DIADEMA SP B M



Light in motion. That is the sensation pervading the environment when one turns on a Diadema. The work of Romani Saccani Architetti Associati, the fathers of this project, first concentrates on the single element of the glass rod and then develops on a composite system: by combining rods of different sizes, the light is reflected and conveys the desired dynamism. Several variants and possibilities for customization are available. Available in the following versions: suspension, applique, table and floor lamp. Crystal shade. Metal parts finishing in satin bronze and chrome.

DIADEMA SP B M

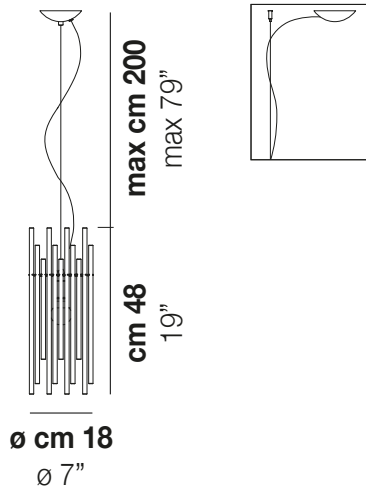

TECHNICAL DATA:



CERTIFICATIONS:



LIGHT SOURCES

1x60 W 120V/60HZ E26

VOLUME Mc 0,06
GROSS WEIGHT Kg 12
NET WEIGHT Kg 8

download



SHADE FINISHING



CR

FRAME FINISHING

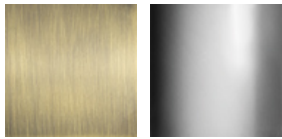

BS

CR

OTHER VERSION AVAILABLE

Click on the version to go to the web version of the product

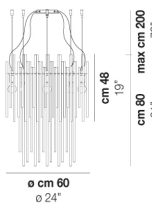

DIADE SP 60 B

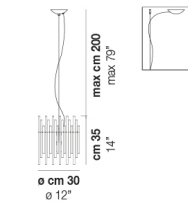

DIADE SP A G

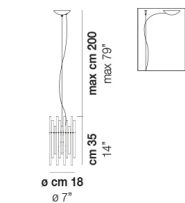

DIADE SP A M

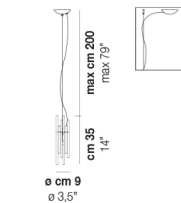

DIADE SP A P

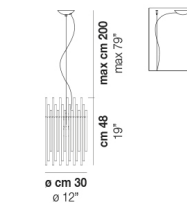

DIADE SP B G

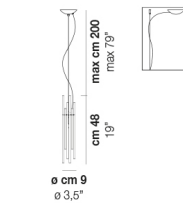

DIADE SP B P

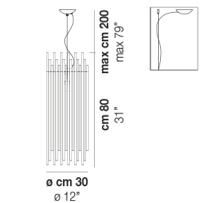

DIADE SP C G

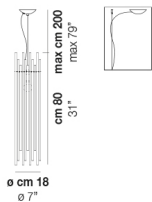

DIADE SP C M

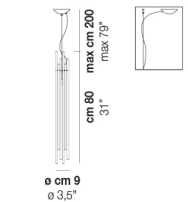

DIADE SP C P

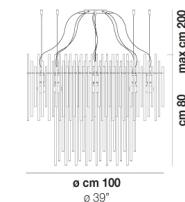

DIADE SP C

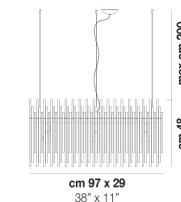

DIADE SP K3

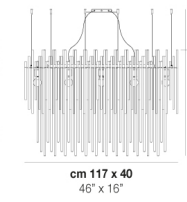

DIADE SP O2