

INSTRUCTION MANUAL

- 1. Always ensure the power is completely OFF before any installation or maintenance.**
- 2. The fixture must be installed by a qualified licensed electrician**

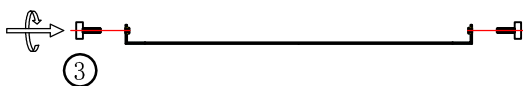

- 1. Ensure main supply is switched off.**
- 2. Make wire across rods, canopy in order, and screw down all rods**
- 3. Have the mounting screw (1) through the mounting bracket and screw into octagon box.**
- 4. Connect the wires using wire nuts. Tight mounting bracket and back plate using screws (2).**
- 5. Fix metal shade firmly into fixture with socket ring.**
- 6. Install light bulb (not provided) into the socket.**
- 7. Put the glass on the metal ring and secure metal ring to metal shade using screw (3).**

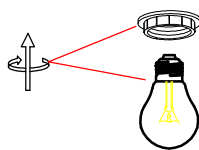
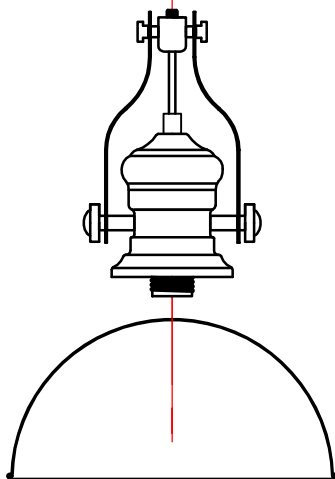
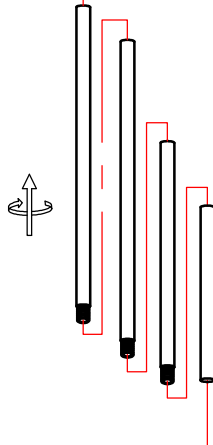
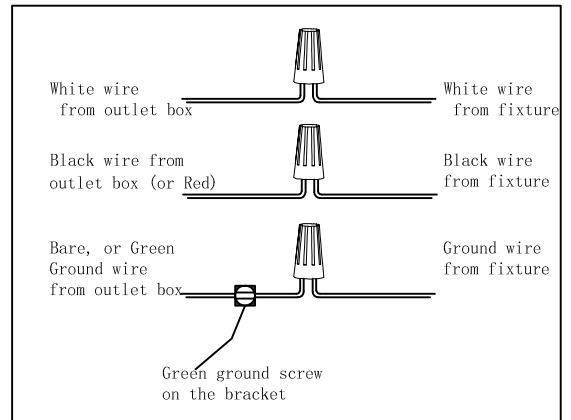
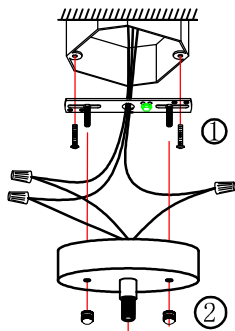
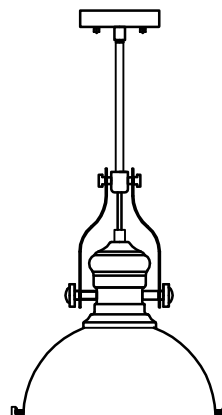

P1010BK
P1010AB/BK