

INSTALLATION INSTRUCTIONS

Model # 72693

READ AND SAVE THESE INSTRUCTIONS

WARNING! SHUT POWER OFF AT FUSE OR CIRCUIT BREAKER.

AVERTISSEMENT! COUPER LE COURANT AU NIVEAU DES FUSIBLES OU DU DISJONCTEUR.

PREPARING FOR INSTALLATION (Fig. 1)

1. Shut off the power at the fuse box or circuit breaker box and remove the old fixture, including the mounting hardware.
2. Carefully unpack your new fixture and lay out all the parts in a clear area. Take care not to misplace any small parts necessary for installation.
3. Attach mounting plate (A) using outlet box screws (B) to the outlet box (C) (not included).
Note: The side of the mounting plate (A) marked "GND" must facing out.

CONNECTING THE WIRES (Fig. 2)

4. Connect the electrical wires as shown in Fig.2. Make sure that all wire connectors are secured. If your outlet box (C) has a ground wire (green or bare copper), connect the fixture's ground wire to it. Otherwise, connect the fixture's ground wire directly to the mounting plate (A) using the green screw (E) provided. Tuck the wire connectors neatly into the outlet box (C).

COMPLETING THE INSTALLATION (Fig. 1)

5. Align back plate (G) onto screws (D) and secure with silicone gasket (J) and ball nuts (H).
6. Install (4) four type B bulbs up to 60 watts or CFL or LED equivalent (not included) in accordance with the fixture specification. **DO NOT EXCEED THE MAXIMUM WATTAGE RATING! (NE PAS DEPASSER LA PUISSANCE NOMINALE MAXIMALE!)**
7. To prevent moisture from entering the outlet box (C) and causing a short, use clear silicone sealant (i.e. Indoor/Outdoor Silicone Sealant) to outline the outside of fixture back plate (G) where it meets the wall leaving a space at bottom to allow moisture a means to escape. (Fig.3)

Your installation is now complete. Return power to the outlet box and test the fixture.

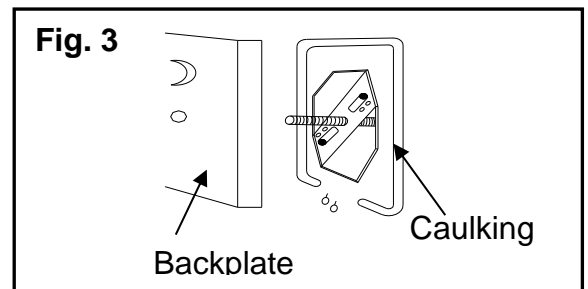
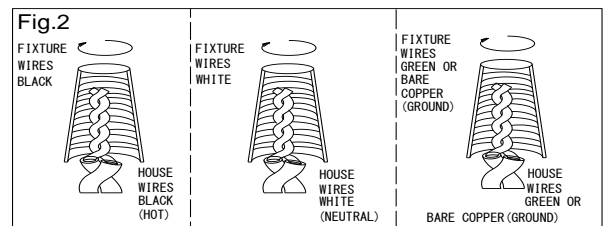
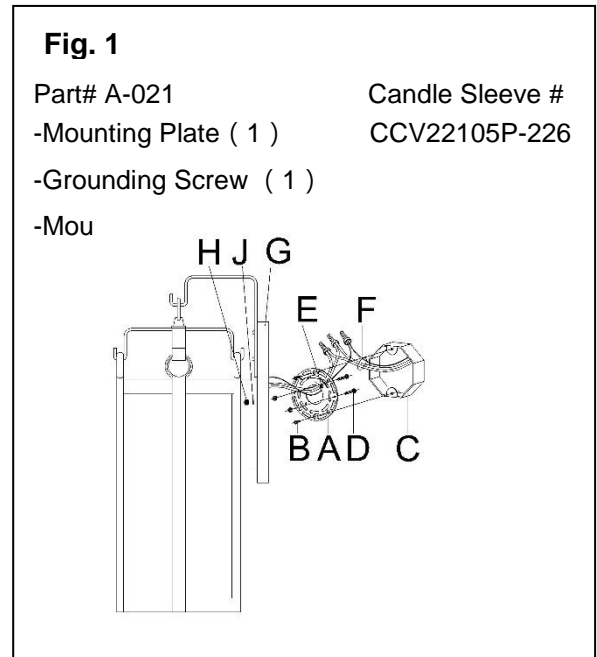

“CAUTION-RISK OF FIRE CONSULT A QUALIFIED ELECTRICIAN TO ENSURE CORRECT BRANCH CIRCUIT CONDUCTOR”

ATTENTION – RISQUE D’INCENDIE, CONSULTER UN ÉLECTRICIEN QUALIFIÉ POUR VOUS ASSURER QUE LES CONDUCTEURS DE LA DÉRIVATION SONT ADÉQUATS.

