

SWELL | SWELL XL SINGLE

DESCRIPTION

Elegant with undulating contours, Swell Single is an LED pendant designed to seamlessly blend the line between indoor and outdoor lighting. Swell single can be suspended individually or as a chandelier grouping to perfectly complement residential, commercial, lounge and hospitality settings alike. Swell is now available in stunning new XL sizes for spaces that demand exceptional scale.

FIXTURE TYPE

Pendant

LIGHT SOURCE

(1) 3000K E26 base 13W PAR30 LED bulb: 1050lm

PRODUCT CODES

| | |
|---------------------------------------|-------------------------|
| Swell Single Narrow (White/Brass): | SWEL SNG NRW WHT/BRA |
| Swell Single Narrow (Black/Brass): | SWEL SNG NRW BLK/BRA |
| Swell Single Narrow (Brass/Brass): | SWEL SNG NRW BRA/BRA |
| Swell Single Medium (White/Brass): | SWEL SNG MED WHT/BRA |
| Swell Single Medium (Black/Brass): | SWEL SNG MED BLK/BRA |
| Swell Single Medium (Brass/Brass): | SWEL SNG MED BRA/BRA |
| Swell Single Wide (White/Brass): | SWEL SNG WID WHT/BRA |
| Swell Single Wide (Black/Brass): | SWEL SNG WID BLK/BRA |
| Swell Single Wide (Brass/Brass): | SWEL SNG WID BRA/BRA |
| Swell Single XL Narrow (White/Brass): | SWEL SNG XL NRW WHT/BRA |
| Swell Single XL Narrow (Black/Brass): | SWEL SNG XL NRW BLK/BRA |
| Swell Single XL Narrow (Brass/Brass): | SWEL SNG XL NRW BRA/BRA |
| Swell Single XL Medium (White/Brass): | SWEL SNG XL MED WHT/BRA |
| Swell Single XL Medium (Black/Brass): | SWEL SNG XL MED BLK/BRA |
| Swell Single XL Medium (Brass/Brass): | SWEL SNG XL MED BRA/BRA |
| Swell Single XL Wide (White/Brass): | SWEL SNG XL WID WHT/BRA |
| Swell Single XL Wide (Black/Brass): | SWEL SNG XL WID BLK/BRA |
| Swell Single XL Wide (Brass/Brass): | SWEL SNG XL WID BRA/BRA |



FINISHES



LIGHT CONTROL

Hard-wired, dimmable

Compatible with TRIAC/ELV dimmers

FEATURES

Fully dimmable

For indoor and outdoor use

Damp rated

Interchangeable shades

SPECIFICATIONS

Voltage: 120V or 240V 60Hz

Power consumption: 13W

Color temperature: 3000K

Note: 2700K/3500K models Available upon Request

Luminosity: 1050 Lumens

Luminaire efficacy: 81 Lumens/Watt

Color Rendition Index: 82 CRI

40K hour lifespan

Cable length: 10' (305cm)

Title 20/Title 24 compliant

Dark Sky compliant

1 year warranty

CERTIFICATIONS



PACKAGING WEIGHT AND DIMENSIONS

| | | |
|---------------|---------|---------------------|
| Swell Single: | 5.25LBS | 15.5" X 16" X 14.5" |
| | 2.4KGS | 39cm X 41cm X 37cm |

NOTES

Custom requests can be considered on volume orders

DIMENSIONS

SWELL SINGLE NARROW

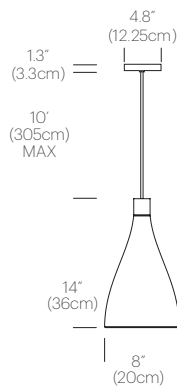

SWELL SINGLE MEDIUM

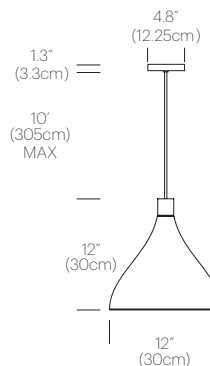

SWELL SINGLE WIDE

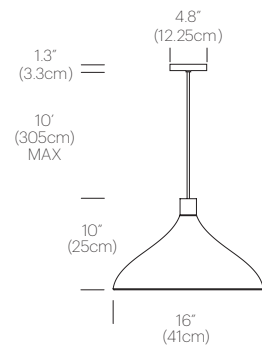

SWELL XL SINGLE NARROW

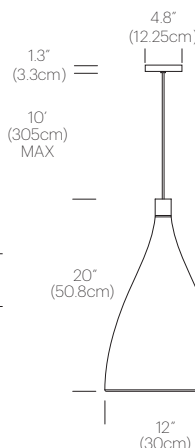

SWELL XL SINGLE MEDIUM

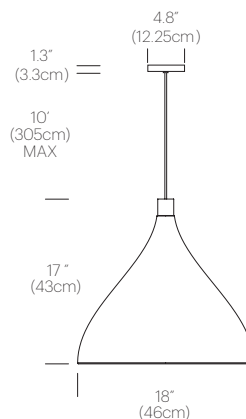

SWELL XL SINGLE WIDE

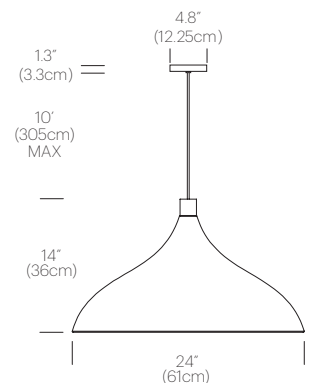

SWELL STRING 3 MIXED

DESCRIPTION

Elegant and infinitely flexible, Swell String is a modular LED lighting system designed to seamlessly blend the line between indoor and outdoor lighting. Swell String's three shade design can be mixed and matched to create dynamic groupings. Swell String can be suspended both vertically and horizontally in configurations of up to (34) lamps from a single power source to perfectly complement residential, commercial, lounge and hospitality settings alike.

FIXTURE TYPE

Pendant

LIGHT SOURCE

(1) 3000K E26 base 13W PAR30 LED bulb: 1050lm

PRODUCT CODES

| | |
|------------------------------------|-------------------------|
| Swell String Mixed (White/Brass): | SWEL STR MIX WHT/BRA |
| Swell String Mixed (Black/Brass): | SWEL STR MIX BLK/BRA |
| Swell String Mixed (Brass/Brass): | SWEL STR MIX BRA/BRA |
| Swell 12" Extension Cable (White): | SWEL STR ACC EXT 12 WHT |
| Swell 12" Extension Cable (Black): | SWEL STR ACC EXT 12 BLK |
| Swell Horizontal Mounting Kit: | SWEL HRZ MOUNT |

LIGHT CONTROL

Hard-wired
ELV dimmer recommended

FEATURES

Fully dimmable
For indoor and outdoor use
Damp rated
Interchangeable shades
Interconnectable sockets

SPECIFICATIONS

Voltage: 120V or 240V 60Hz
Power consumption: 13W
Color temperature: 3000K
Note: 2700K/3500K models Available upon Request
Luminosity: 1050 Lumens
Luminaire efficacy: 81 Lumens/Watt
Color Rendition Index: 90 CRI
40K hour lifespan
(3x) 10' (305cm) vertical mounting kit cable included
30' (915cm) horizontal mounting kit cable sold separately
8' (244cm) power feed cable and canopy included
Horizontal mounting kit supports 12 lamps MAX
MAX interconnected 14.5W lamps: 34
Title 20/Title 24 compliant
Dark Sky compliant
1 year warranty

CERTIFICATIONS



PACKAGING WEIGHT AND DIMENSIONS

| | | |
|-----------------------|---------|---------------------|
| Swell String 3 Mixed: | 12.3LBS | 16.5" X 16" X 14.5" |
| | 5.6KGS | 42cm X 41cm X 37cm |

NOTES

Custom requests can be considered on volume orders



FINISHES



DIMENSIONS

SWELL STRING 3 MIXED VERTICAL

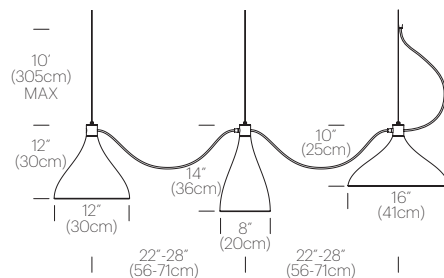

SWELL STRING 3 MIXED HORIZONTAL

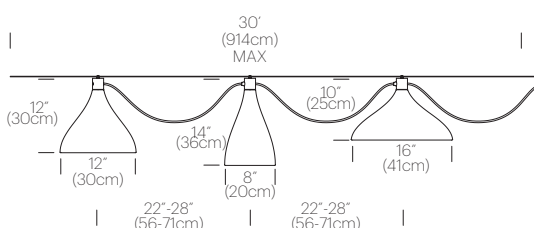

HORIZONTAL MOUNTING KIT

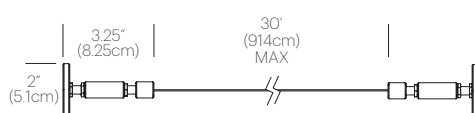

12" JUMPER CABLE



SWELL STRING SINGLE

DESCRIPTION

Elegant and infinitely flexible, Swell String Single is a modular LED lighting system designed to seamlessly blend the line between indoor and outdoor lighting. Swell String Single allows infinite customization, pick your own collection to create a dramatic and personal grouping to fit any environment. Swell String Single can be suspended both vertically and horizontally in configurations of up to (34) lamps from a single power source to perfectly complement residential, commercial, lounge and hospitality settings alike.

FIXTURE TYPE

Pendant

LIGHT SOURCE

(1) 3000K E26 base 13W PAR30 LED bulb: 1050lm

PRODUCT CODES

| | |
|---|--------------------------|
| Swell String Single Narrow (White/Brass): | SWEL STR SNG NRW WHT/BRA |
| Swell String Single Narrow (Black/Brass): | SWEL STR SNG NRW BLK/BRA |
| Swell String Single Narrow (Brass/Brass): | SWEL STR SNG NRW BRA/BRA |
| Swell String Single Medium (White/Brass): | SWEL STR SNG MED WHT/BRA |
| Swell String Single Medium (Black/Brass): | SWEL STR SNG MED BLK/BRA |
| Swell String Single Medium (Brass/Brass): | SWEL STR SNG NRW BRA/BRA |
| Swell String Single Wide (White/Brass): | SWEL STR SNG WID WHT/BRA |
| Swell String Single Wide (Black/Brass): | SWEL STR SNG WID BLK/BRA |
| Swell String Single Wide (Brass/Brass): | SWEL STR SNG NRW BRA/BRA |
| Swell Power Feed and Canopy (White): | SWEL STR ACC KIT WHT |
| Swell Power Feed and Canopy (Black): | SWEL STR ACC KIT BLK |
| Swell 12' Extension Cable (White): | SWEL STR ACC EXT 12 WHT |
| Swell 12' Extension Cable (Black): | SWEL STR ACC EXT 12 BLK |
| Swell Horizontal Mounting Kit: | SWEL HRZ MOUNT |

LIGHT CONTROL

Hard-wired
ELV dimmer recommended

FEATURES

Fully dimmable
For indoor and outdoor use
Damp rated
Interchangeable shades
Interconnectable sockets

SPECIFICATIONS

Voltage: 120V or 240V 60Hz
Power consumption: 13W
Color temperature: 3000K
Note: 2700K/3500K models Available upon Request
Luminosity: 1050 Lumens
Luminaire efficacy: 81 Lumens/Watt
Color Rendition Index: 90 CRI
40K hour lifespan
(1x) 10' (305cm) vertical mounting kit cable included
30' (915cm) horizontal mounting kit cable sold separately
8' (244cm) power feed cable and canopy sold separately
Horizontal mounting kit supports 12 lamps MAX
MAX interconnected 14.5W lamps: 34
Title 20/Title 24 compliant
Dark Sky compliant
1 year warranty

CERTIFICATIONS



PACKAGING WEIGHT AND DIMENSIONS

Swell String Single: 5.25LBS 15.5" X 16" X 14.5"
2.4KGS 39cm X 41cm X 37cm

NOTES

Custom requests can be considered on volume orders

Pablo



FINISHES



DIMENSIONS

SWELL STRING SINGLE NARROW SWELL STRING SINGLE MEDIUM SWELL STRING SINGLE WIDE

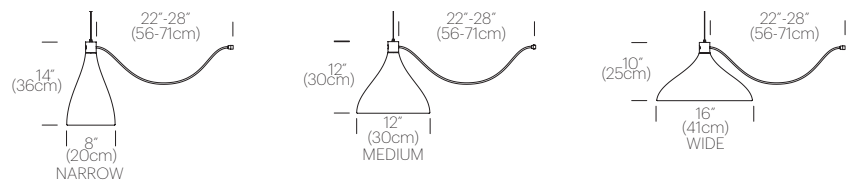

POWER FEED CABLE

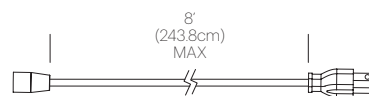

CANOPY

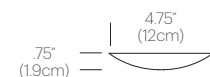

HORIZONTAL MOUNTING KIT

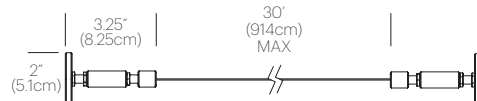

12' EXTENSION CABLE



SWELL CHANDELIER

DESCRIPTION

Elegant with undulating contours, Swell Chandelier is an LED chandelier designed to seamlessly blend the line between indoor and outdoor lighting. Swell Chandelier is available in groupings of 3 and 6 lamps, creating a dramatic and personal grouping to fit any environment.

FIXTURE TYPE

Pendant

LIGHT SOURCE

(1) 3000K E26 base 13W PAR30 LED bulb: 1050lm per lamp

PRODUCT CODES

| | |
|------------------------------------|----------------------|
| Swell Single Narrow (White/Brass): | SWEL SNG NRW WHT/BRA |
| Swell Single Narrow (Black/Brass): | SWEL SNG NRW BLK/BRA |
| Swell Single Narrow (Brass/Brass): | SWEL SNG NRW BRA/BRA |
| Swell Single Medium (White/Brass): | SWEL SNG MED WHT/BRA |
| Swell Single Medium (Black/Brass): | SWEL SNG MED BLK/BRA |
| Swell Single Medium (Brass/Brass): | SWEL SNG MED BRA/BRA |
| Swell Single Wide (White/Brass): | SWEL SNG WID WHT/BRA |
| Swell Single Wide (Black/Brass): | SWEL SNG WID BLK/BRA |
| Swell Single Wide (Brass/Brass): | SWEL SNG WID BRA/BRA |
| 17" Chandelier Canopy: | CHIND CAN 17 |
| 26" Chandelier Canopy: | CHIND CAN 26 |

LIGHT CONTROL

Hard-wired
ELV dimmer recommended

FEATURES

Fully dimmable
For indoor and outdoor use
Damp rated
Interchangeable shades

SPECIFICATIONS

Voltage: 120V or 240V 60Hz
Power consumption: 13W per lamp
Color temperature: 3000K
Note: 2700K/3500K models Available upon Request
Luminosity: 1050 Lumens per lamp
Luminaire efficacy: 81 Lumens/Watt
Color Rendition Index: 90 CRI
40K hour lifespan
Cable length: 10' (305cm)
Title 20/Title 24 compliant
Dark Sky compliant
1 year warranty

CERTIFICATIONS



PACKAGING WEIGHT AND DIMENSIONS

| | | |
|------------------------|---------|---------------------|
| Swell Single: | 5.25LBS | 15.5" X 16" X 14.5" |
| | 2.4KGS | 39cm X 41cm X 37cm |
| Chandelier canopy 26": | 30LBS | 32" X 32" X 6" |
| | 13.6KGS | 81cm X 81cm X 15cm |
| Chandelier canopy 17": | 15LBS | 22" X 22" X 6" |
| | 6.8KGS | 56cm X 56cm X 15cm |

NOTES

Custom requests can be considered on volume orders



FINISHES



WHITE/
BRASS



BLACK/
BRASS



BRASS/
BRASS

CANOPY



WHITE

DIMENSIONS

SWELL CHANDELIER 3

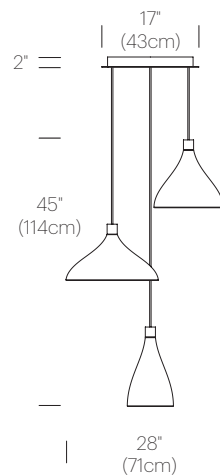

SWELL CHANDELIER 6

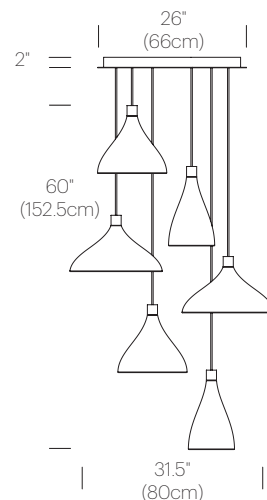

CHANDELIER CANOPY 17"

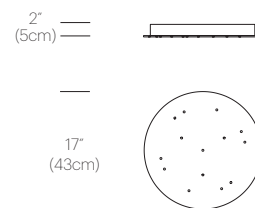

CHANDELIER CANOPY 26"

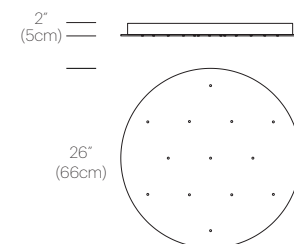

SWELL | SWELL XL SINGLE

DESCRIPTION

Elegant with undulating contours, Swell Single is an LED pendant designed to seamlessly blend the line between indoor and outdoor lighting. Swell single can be suspended individually or as a chandelier grouping to perfectly complement residential, commercial, lounge, and hospitality settings alike. Swell is now available in stunning new XL sizes for spaces that demand exceptional scale.

FIXTURE TYPE

Pendant

LIGHT SOURCE

(1) 3000K E26 base 13W PAR30 LED bulb: 1050lm

PRODUCT CODES

| | |
|------------------------------------|----------------------|
| Swell Single Narrow (White/Brass): | SWEL SNG NRW WHT/BRA |
| Swell Single Narrow (Black/Brass): | SWEL SNG NRW BLK/BRA |
| Swell Single Narrow (Brass/Brass): | SWEL SNG NRW BRA/BRA |
| Swell Single Medium (White/Brass): | SWEL SNG MED WHT/BRA |
| Swell Single Medium (Black/Brass): | SWEL SNG MED BLK/BRA |
| Swell Single Medium (Brass/Brass): | SWEL SNG MED BRA/BRA |
| Swell Single Wide (White/Brass): | SWEL SNG WID WHT/BRA |
| Swell Single Wide (Black/Brass): | SWEL SNG WID BLK/BRA |
| Swell Single Wide (Brass/Brass): | SWEL SNG WID BRA/BRA |

LIGHT CONTROL

Hard-wired
ELV dimmer recommended

FEATURES

Fully dimmable
For indoor and outdoor use
Damp rated
Interchangeable shades
interconnectable sockets

SPECIFICATIONS

Voltage : 120V or 240V 60Hz
Power consumption: 13W
Color temperature: 3000K
Note: 2700K/3500K models Available upon Request
Luminosity: 1050 Lumens
Luminaire efficacy: 81 Lumens/Watt
Color Rendition Index: 90 CRI
40K hour lifespan
(3x) 10' (305cm) vertical mounting kit cable included
30' (915cm) horizontal mounting kit cable sold separately
8' (244cm) power feed cable and canopy included
Horizontal mounting kit supports 12 lamps MAX
MAX interconnected 14.5W lamps: 34
Title 20/Title 24 compliant
Dark Sky compliant
1 year warranty

CERTIFICATIONS



PACKAGING WEIGHT AND DIMENSIONS

| | | |
|------------------|--------|--------------------|
| Swell Narrow: | 6LBS | 17" X 17" X 15" |
| | 2.7KG | 43CM X 43CM X 38CM |
| Swell Medium: | 6LBS | 17" X 17" X 15" |
| | 2.7KG | 43CM X 43CM X 38CM |
| Swell Wide: | 6LBS | 17" X 17" X 15" |
| | 2.7KG | 43CM X 43CM X 38CM |
| Swell XL Narrow: | 6.6LBS | 14" X 14" X 20" |
| | 3KG | 36CM X 36CM X 51CM |
| Swell XL Medium: | 7.6LBS | 20" X 20" X 18" |
| | 3.4KG | 51CM X 51CM X 46CM |
| Swell XL Wide: | 10LBS | 26" X 26" X 14" |
| | 4.5KG | 66CM X 66CM X 36CM |

NOTES

Custom requests can be considered on volume orders

Pablo



| | |
|---------------------------------------|-------------------------|
| Swell Single XL Narrow (White/Brass): | SWEL SNG XL NRW WHT/BRA |
| Swell Single XL Narrow (Black/Brass): | SWEL SNG XL NRW BLK/BRA |
| Swell Single XL Narrow (Brass/Brass): | SWEL SNG XL NRW BRA/BRA |
| Swell Single XL Medium (White/Brass): | SWEL SNG XL MED WHT/BRA |
| Swell Single XL Medium (Black/Brass): | SWEL SNG XL MED BLK/BRA |
| Swell Single XL Medium (Brass/Brass): | SWEL SNG XL MED BRA/BRA |
| Swell Single XL Wide (White/Brass): | SWEL SNG XL WID WHT/BRA |
| Swell Single XL Wide (Black/Brass): | SWEL SNG XL WID BLK/BRA |
| Swell Single XL Wide (Brass/Brass): | SWEL SNG XL WID BRA/BRA |

FINISHES



DIMENSIONS

SWELL SINGLE NARROW

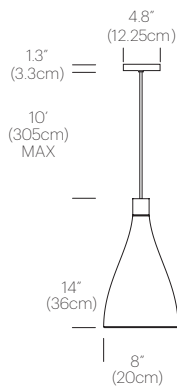

SWELL SINGLE MEDIUM

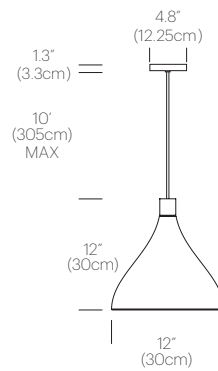

SWELL SINGLE WIDE

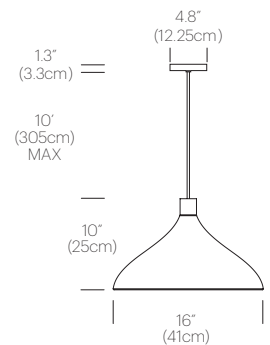

SWELL XL SINGLE NARROW

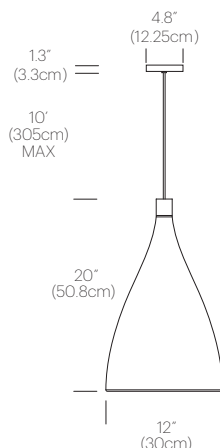

SWELL XL SINGLE MEDIUM

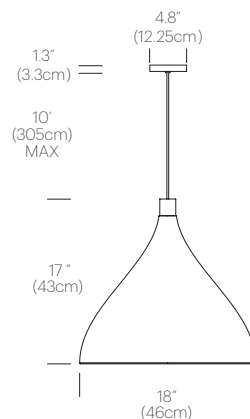

SWELL XL SINGLE WIDE

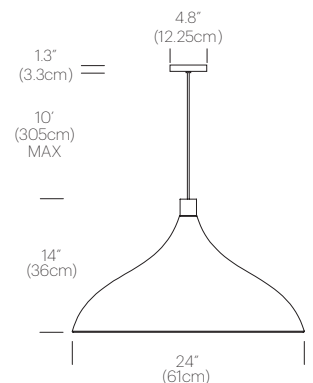

SWELL XL STRING 3 MIXED

DESCRIPTION

Elegant and infinitely flexible, Swell XL String is a modular LED lighting system designed to seamlessly blend the line between indoor and outdoor lighting. Swell XL String's three shade designs can be mixed and matched to create dynamic groupings. Swell XL String can be suspended both vertically and horizontally in configurations of up to (34) lamps from a single power source to perfectly complement residential, commercial, lounge and hospitality settings alike.

FIXTURE TYPE

Pendant

LIGHT SOURCE

(1) 3000K E26 base 13W PAR30 LED bulb: 1050lm

PRODUCT CODES

| | |
|--------------------------------------|-------------------------|
| Swell String XL Mixed (White/Brass): | SWEL STR XL MIX WHT/BRA |
| Swell String XL Mixed (Black/Brass): | SWEL STR XL MIX BLK/BRA |
| Swell String XL Mixed (Brass/Brass): | SWEL STR XL MIX BRA/BRA |
| Swell 12' Extension Cable (White): | SWEL STR ACC EXT 12 WHT |
| Swell 12' Extension Cable (Black): | SWEL STR ACC EXT 12 BLK |
| Swell Horizontal Mounting Kit: | SWEL HRZ MOUNT |

LIGHT CONTROL

Hard-wired
ELV dimmer recommended

FEATURES

Fully dimmable
For indoor and outdoor use
Damp rated
Interchangeable shades
interconnectable sockets

SPECIFICATIONS

Voltage : 120V or 240V 60Hz
Power consumption: 13W
Color temperature: 3000K
Note: 2700K/3500K models Available upon Request
Luminosity: 1050 Lumens
Luminaire efficacy: 81 Lumens/Watt
Color Rendition Index: 90 CRI
40K hour lifespan
(3x) 10' (305cm) vertical mounting kit cable included
30' (915cm) horizontal mounting kit cable sold separately
8' (244cm) power feed cable and canopy included
Horizontal mounting kit supports 12 lamps MAX
MAX interconnected 14.5W lamps: 34
Title 20/Title 24 compliant
Dark Sky compliant
1 year warranty

CERTIFICATIONS



PACKAGING WEIGHT AND DIMENSIONS

| | | |
|------------------|-----------------|---------------------------------------|
| Swell XL Narrow: | 6.6LBS 3KG | 14" X 14" X 20" 36CM X 36CM X 51CM |
| Swell XL Medium: | 7.6LBS 3.4KG | 20" X 20" X 18" 51CM X 51CM X 46CM |
| Swell XL Wide: | 10LBS 4.5KG | 26" X 26" X 14" 66CM X 66CM X 36CM |

NOTES

Custom requests can be considered on volume orders



FINISHES



DIMENSIONS

SWELL XL STRING 3 MIXED VERTICAL

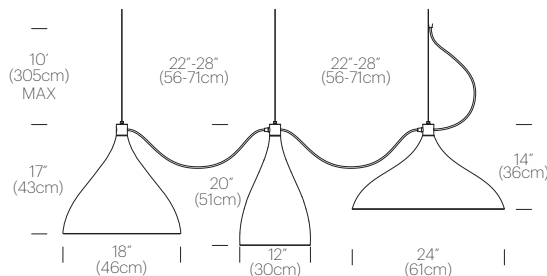

SWELL XL STRING 3 MIXED HORIZONTAL

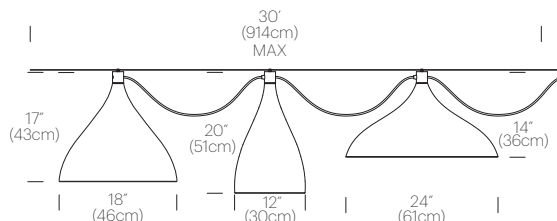

HORIZONTAL MOUNTING KIT

12" JUMPER CABLE

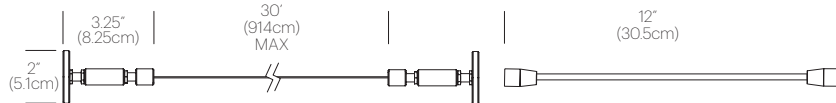

SWELL XL STRING SINGLE

DESCRIPTION

Elegant and infinitely flexible, Swell XL String Single is a modular LED lighting system designed to seamlessly blend the line between indoor and outdoor lighting. Swell XL String Single allows infinite customization, pick your own collections to create a dramatic and personal grouping to fit any environment. Swell XL String Single can be suspended both vertically and horizontally in configurations of up to (34) lamps from a single power source to perfectly complement residential, commercial, lounge and hospitality settings alike.

FIXTURE TYPE

Pendant

LIGHT SOURCE

(1) 3000K E26 base 13W PAR30 LED bulb: 1050lm

PRODUCT CODES

| | |
|--|-----------------------------|
| Swell String Single XL Narrow (White/Brass): | SWEL STR SNG XL NRW WHT/BRA |
| Swell String Single XL Narrow (Black/Brass): | SWEL STR SNG XL NRW BLK/BRA |
| Swell String Single XL Narrow (Brass/Brass): | SWEL STR SNG XL NRW BRA/BRA |
| Swell String Single XL Medium (White/Brass): | SWEL STR SNG XL MED WHT/BRA |
| Swell String Single XL Medium (Black/Brass): | SWEL STR SNG XL MED BLK/BRA |
| Swell String Single XL Medium (Brass/Brass): | SWEL STR SNG XL MED BRA/BRA |
| Swell String Single XL Wide (White/Brass): | SWEL STR SNG XL WID WHT/BRA |
| Swell String Single XL Wide (Black/Brass): | SWEL STR SNG XL WID BLK/BRA |
| Swell String Single XL Wide (Brass/Brass): | SWEL STR SNG XL WID BRA/BRA |
| Swell Power Feed and Canopy (White): | SWEL STR ACC KIT WHT |
| Swell Power Feed and Canopy (Black): | SWEL STR ACC KIT BLK |
| Swell 12" Extension Cable (White): | SWEL STR ACC EXT 12 WHT |
| Swell 12" Extension Cable (Black): | SWEL STR ACC EXT 12 BLK |
| Swell Horizontal Mounting Kit: | SWEL HRZ MOUNT |

LIGHT CONTROL

Hard-wired
ELV dimmer recommended

FEATURES

Fully dimmable
For indoor and outdoor use
Damp rated
Interchangeable shades
interconnectable sockets

SPECIFICATIONS

Voltage : 120V or 240V 60Hz
Power consumption: 13W
Color temperature: 3000K
Note: 2700K/3500K models Available upon Request
Luminosity: 1050 Lumens
Luminaire efficacy: 81 Lumens/Watt
Color Rendition Index: 90 CRI
40K hour lifespan
(3x) 10' (305cm) vertical mounting kit cable included
30' (915cm) horizontal mounting kit cable sold separately
8' (244cm) power feed cable and canopy included
Horizontal mounting kit supports 12 lamps MAX
MAX interconnected 14.5W lamps: 24
Title 20/Title 24 compliant
Dark Sky compliant
1 year warranty

CERTIFICATIONS



PACKAGING WEIGHT AND DIMENSIONS

| | | |
|------------------|-----------------|---------------------------------------|
| Swell XL Narrow: | 6.6LBS 3KG | 14" X 14" X 20" 36CM X 36CM X 51CM |
| Swell XL Medium: | 7.6LBS 3.4KG | 20" X 20" X 18" 51CM X 51CM X 46CM |
| Swell XL Wide: | 10LBS 4.5KG | 26" X 26" X 14" 66CM X 66CM X 36CM |

NOTES

Custom requests can be considered on volume orders



FINISHES



DIMENSIONS

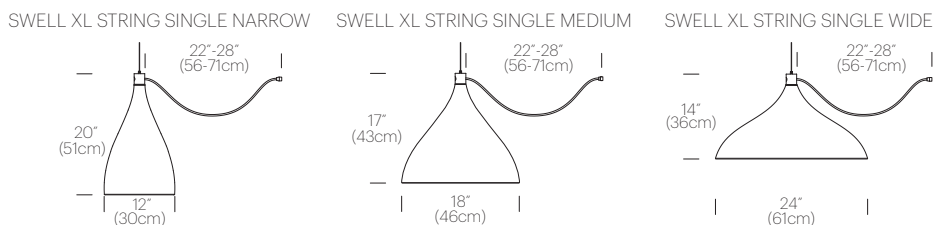

POWER FEED CABLE

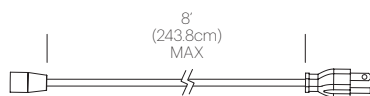

CANOPY

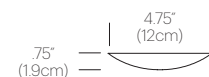

HORIZONTAL MOUNTING KIT

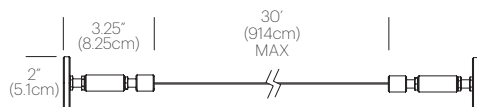

12" EXTENSION CABLE



SWELL XL CHANDELIER

DESCRIPTION

Elegant with undulating contours, Swell XL Chandelier is an LED chandelier designed to seamlessly blend the line between indoor and outdoor lighting. Swell XL Chandelier is available in groupings of 3 and 6 lamps, creating a dramatic and personal grouping to fit any environment.

FIXTURE TYPE

Pendant

LIGHT SOURCE

(1) 3000K E26 base 13W PAR30 LED bulb: 1050lm

PRODUCT CODES

| | |
|------------------------------------|----------------------|
| Swell Single Narrow (White/Brass): | SWEL SNG NRW WHT/BRA |
| Swell Single Narrow (Black/Brass): | SWEL SNG NRW BLK/BRA |
| Swell Single Narrow (Brass/Brass): | SWEL SNG NRW BRA/BRA |
| Swell Single Medium (White/Brass): | SWEL SNG MED WHT/BRA |
| Swell Single Medium (Black/Brass): | SWEL SNG MED BLK/BRA |
| Swell Single Medium (Brass/Brass): | SWEL SNG MED BRA/BRA |
| Swell Single Wide (White/Brass): | SWEL SNG WID WHT/BRA |
| Swell Single Wide (Black/Brass): | SWEL SNG WID BLK/BRA |
| Swell Single Wide (Brass/Brass): | SWEL SNG WID BRA/BRA |
| 26" Chandelier Canopy: | CHND CAN 26 |

LIGHT CONTROL

Hard-wired

ELV dimmer recommended

FEATURES

Fully dimmable

For indoor and outdoor use

Damp rated

Interchangeable shades

interconnectable sockets

SPECIFICATIONS

Voltage : 120V or 240V 60Hz

Power consumption: 13W

Color temperature: 3000K

Note: 2700K/3500K models Available upon Request

Luminosity: 1050 Lumens

Luminaire efficacy: 81 Lumens/Watt

Color Rendition Index: 90 CRI

40K hour lifespan

(3x) 10' (305cm) vertical mounting kit cable included

30' (915cm) horizontal mounting kit cable sold separately

8' (244cm) power feed cable and canopy included

Horizontal mounting kit supports 12 lamps MAX

MAX interconnected 14.5W lamps: 34

Title 20/Title 24 compliant

Dark Sky compliant

1 year warranty

CERTIFICATIONS



FINISHES



WHITE/
BRASS



BLACK/
BRASS



BRASS/
BRASS

CANOPY



WHITE

DIMENSIONS

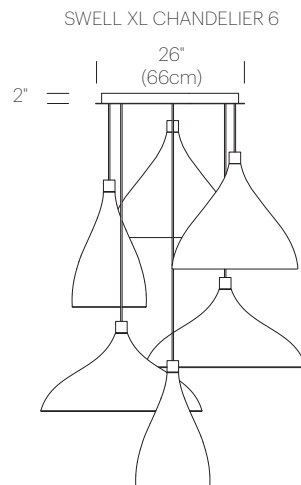
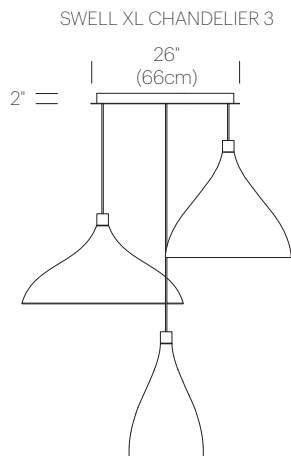

PACKAGING WEIGHT AND DIMENSIONS

| | | |
|------------------------|--------|--------------------|
| Swell XL Narrow: | 6.6LBS | 14" X 14" X 20" |
| | 3KG | 36CM X 36CM X 51CM |
| Swell XL Medium: | 7.6LBS | 20" X 20" X 18" |
| | 3.4KG | 51CM X 51CM X 46CM |
| Swell XL Wide: | 10LBS | 26" X 26" X 14" |
| | 4.5KG | 66CM X 66CM X 36CM |
| Chandelier canopy 26": | 30LBS | 32" X 32" X 6" |
| | 14KG | 81CM X 81CM X 15CM |

NOTES

Custom requests can be considered on volume orders

Pablo

CHANDELIER CANOPY 26"

