

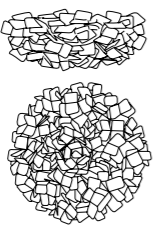

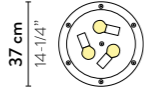









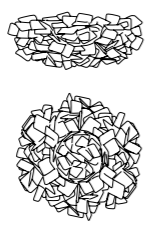
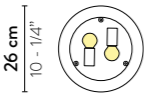

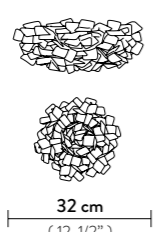
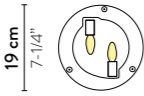

PRODUCT / PRODOTTO	DIMENSIONS / MISURE	COLOUR / COLORE	CODE / CODICE
CEILING / WALL LARGE Bulbs E27:  3 X 12W LED Filament Dimmable with: Dimmable bulbs Made of: Opalflex® / Cristalflex® / Lentiflex® With: Magnetic System® Weight: net Kg 4,5 - gross Kg 6,5 Package: 80 x 80 x h. 30 cm CB REPORT AVAILABLE	 <p>25 cm (9-3/4")</p> <p>78 cm (30-3/4")</p> <p>LIGHT SOURCE:</p>  <p>37 cm 14-1/4"</p>	■ BLACK CLI78PLF0003N_000	
		□ WHITE CLI78PLF0003W_000	
		■ ORANGE CLI78PLF0003A_000	
		■ PURPLE CLI78PLF0003P_000	
		 MAMA NON MAMA CLI78PLF0003MN000	
		 PIXEL CLI78PLF0003PX000	
 FUMÉ CLI78PLF0003F_000			
CEILING / WALL MEDIUM Bulbs E27:  2 X 12W LED Filament Dimmable with: Dimmable bulbs Made of: Opalflex® / Cristalflex® / Lentiflex® With: Magnetic System® Weight: net Kg 2 - gross Kg 2,3 Package: 57 x 55 x h. 23 cm CB REPORT AVAILABLE	 <p>20 cm 8"</p> <p>53 cm (20-3/4")</p> <p>LIGHT SOURCE:</p>  <p>26 cm 10 - 1/4"</p>	■ BLACK CLI78PLF0000N_000	
		□ WHITE CLI78PLF0000W_000	
		■ ORANGE CLI78PLF0000A_000	
		■ PURPLE CLI78PLF0000P_000	
		■ BLUE CLI78PLF0000B_000	
		 MAMA NON MAMA CLI78PLF0000MN000	
 PIXEL CLI78PLF0000PX000			
 FUMÉ CLI78PLF0000F_000			
CEILING / WALL MINI Bulbs E14:  2 X 6W LED Filament Dimmable with: Dimmable bulbs Made of: Opalflex® / Cristalflex® / Lentiflex® With: Magnetic System® Weight: net Kg 0,6 - gross Kg 1,4 Package: 36 x 38 x h. 15 cm CB REPORT AVAILABLE	 <p>15 cm 5-3/4"</p> <p>32 cm (12-1/2")</p> <p>LIGHT SOURCE:</p>  <p>19 cm 7-1/4"</p>	■ BLACK CLI78PLF0001N_000	
		□ WHITE CLI78PLF0001W_000	
		■ ORANGE CLI78PLF0001A_000	
		■ PURPLE CLI78PLF0001P_000	
		 MAMA NON MAMA CLI78PLF0001MN000	
		 PIXEL CLI78PLF0001PX000	
 FUMÉ CLI78PLF0001F_000			

PRODUCT / PRODOTTO	DIMENSIONS / MISURE	COLOUR / COLORE	CODE / CODICE
APPLIQUE Bulbs E14:  2 X 6W LED Filament Dimmable with: Dimmable bulbs Made of: Cristalflex® With: Magnetic System® Weight: net Kg 0,6 - gross Kg 1,4 Package: 36 x 38 x h. 15 cm	 <p>28 cm 10-3/4"</p> <p>15 cm 5-3/4"</p> <p>32 cm (12-1/2")</p> <p>LIGHT SOURCE:</p>  <p>19 cm 7-1/4"</p>	 MAMA NON MAMA CLI78APP0000MN000	
		 PIXEL CLI78APP0000PX000	

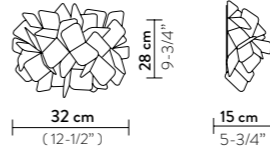
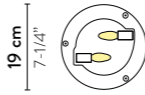
CLIZIA ENTIRE COLLECTION

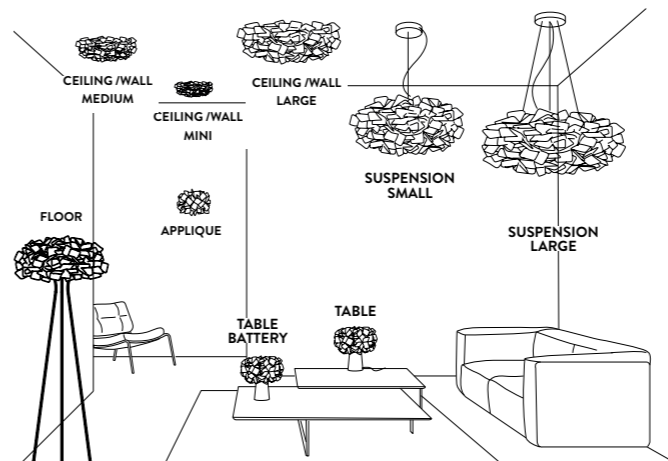



CERTIFICATION

CE IP 20  

ENERGY CLASS: A / A+ / A++
 ENERGY LABEL AVAILABLE ON SLAMP'S WEBSITE

FINISHES



MAMA
NON MAMA

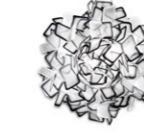

PIXEL



FUMÉ

BLACK

WHITE

ORANGE

PURPLE



BLUE

CLIZIA SUSPENSION by Adriano Rachele

Compendium page 70

PRODUCT / PRODOTTO	DIMENSIONS / MISURE	COLOUR / COLORE	CODE / CODICE
SUSPENSION LARGE Bulbs E27: 4 X 12W LED Filament Dimmable with: Dimmable bulbs Made of: Lentiflex® / Cristalflex® or Opalfex® With: Magnetic System® Weight: net Kg 2,94 - gross Kg 7,6 Package: 80 x 80 x h. 30 cm CB REPORT AVAILABLE		■ BLACK □ WHITE ■ ORANGE ■ PURPLE ■ MAMA NON MAMA RED WIRE ■ MAMA NON MAMA TRANSP. WIRE ■ PIXEL RED WIRE ■ PIXEL TRANSP. WIRE ■ FUMÉ	CLI78SOS0003N_000 CLI78SOS0003W_000 CLI78SOS0003A_000 CLI78SOS0003P_000 CLI78SOS0003MN000 CLI78SOST003MN000 CLI78SOS0003PX000 CLI78SOST003PX000 CLI78SOS0003F_000
		■ BLACK □ WHITE ■ ORANGE ■ PURPLE ■ BLUE ■ MAMA NON MAMA RED WIRE ■ MAMA NON MAMA TRANSP. WIRE ■ PIXEL RED WIRE ■ PIXEL TRANSP. WIRE ■ FUMÉ	CLI78SOS0000N_000 CLI78SOS0000W_000 CLI78SOS0000A_000 CLI78SOS0000P_000 CLI78SOS0000B_000 CLI78SOS0000MN000 CLI78SOST000MN000 CLI78SOS0000PX000 CLI78SOST000PX000 CLI78SOS0000F_000

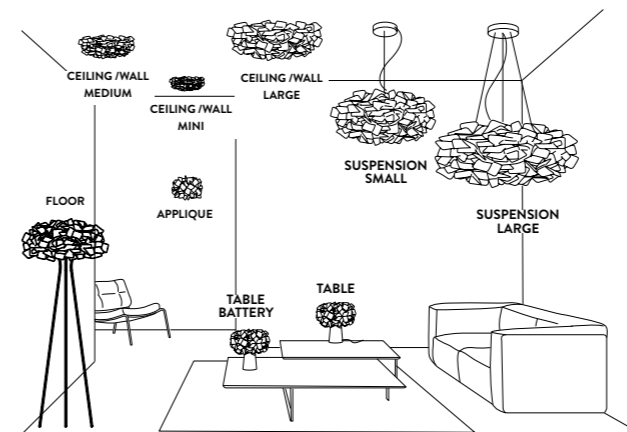
CLIZIA ENTIRE COLLECTION



CANOPY DETAILS

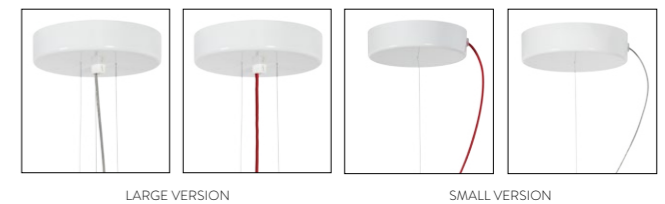

CLIZIA SUSPENSION

LARGE: Ø 14 cm x h. 3 cm (Ø 5-1/2" x h. 1")
MEDIUM: Ø 12 cm x h. 3,2 cm (Ø 4-3/4" x h. 1-1/4")

Red wrapped electric wire - Available also with transparent cable
 Cavo calzato rosso - Disponibile anche con cavo trasparente
 6m. cable kit must be ordered with lamp purchase
 Kit Cavi da 6m da richiedere tassativamente in fase di ordine
 Kit di installazione multipla su richiesta
 Multiple installation kit on request

CERTIFICATION

CE IP 20

ENERGY CLASS: A / A+ / A++
 ENERGY LABEL: AVAILABLE ON SLAMP'S WEBSITE

FINISHES

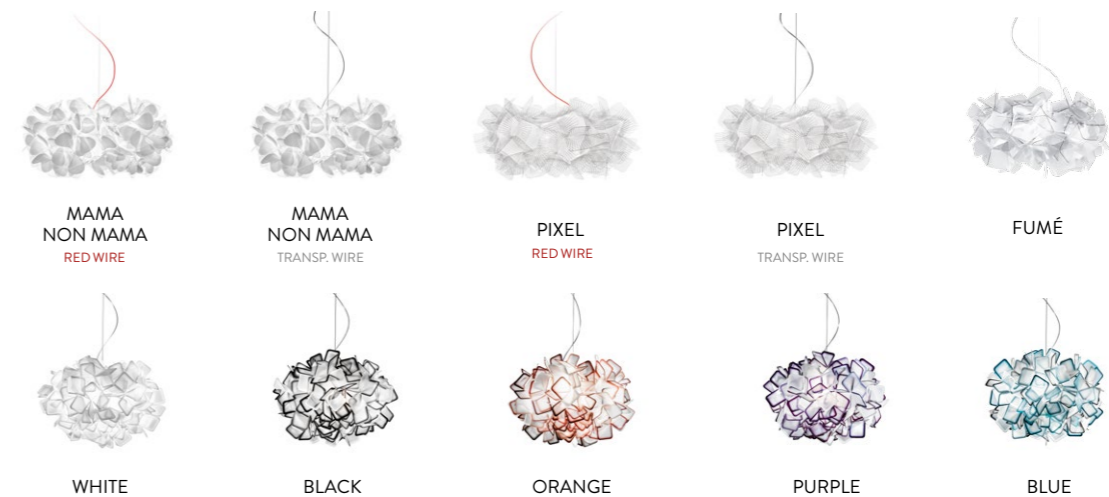

CLIZIA BATTERY

by Adriano Rachele

Compendium page 272

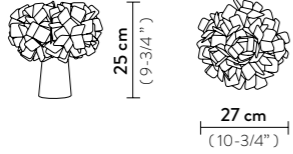
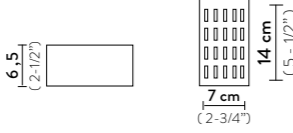
PRODUCT / PRODOTTO	DIMENSIONS / MISURE	COLOUR / COLORE	CODE / CODICE
TABLE LAMP LED: 1.8W Battery LED - 350 Lumen 2700 Kelvin Recargable Li-ion battery 14 hours operating time 5 hours recharging time Made of: Lentiflex® / Cristalflex® With: USB / DC plug included Gift pack Weight: net Kg 0,61 - gross Kg 1,2 Package: 29 x 28 x h. 26 cm		<input type="checkbox"/> FUMÉ <input type="checkbox"/> MAMA NON MAMA	CLI78TAVB0C1F_000 CLI78TAVB0C1MN000
USB MULTICHARGER STATION 20 PORTS With: 20 USB, wire 1,50 m fan automatic heat dissipation Weight: net Kg 0,49 - gross Kg 0,53 Package: 15,5 x 15,5 x h. 7 cm			ACC00CHAP020_000

CLIZIA TABLE

design by Adriano Rachele

Compendium page 278

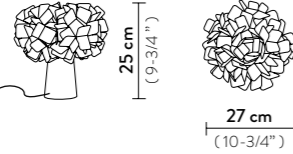
PRODOTTI	MISURE	COLORI	CODICI
TABLE LAMP Bulbs E14 1 X 6W LED Filament Made of: Lentiflex® / Cristalflex Fumé® With: MagneticSystem® Coloured steel base Weight: net Kg 0,61 - gross Kg 1,2 Package: 29 x 28 x h. 26 cm CB REPORT AVAILABLE		<input type="checkbox"/> BLACK <input type="checkbox"/> WHITE <input type="checkbox"/> ORANGE <input type="checkbox"/> PURPLE <input type="checkbox"/> FUMÉ	CLI78TAV0001N_000 CLI78TAV0001W_000 CLI78TAV0001A_000 CLI78TAV0001H_000 CLI78TAV0001F_000

FINISHES



CLIZIA FLOOR

design by Adriano Rachele

Compendium page 416

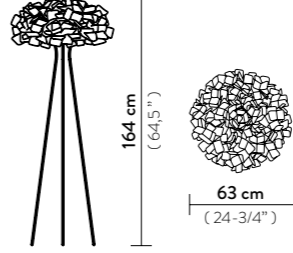
PRODUCT / PRODOTTO	DIMENSIONS / MISURE	COLOUR / COLORE	CODE / CODICE
FLOOR Bulbs E27: 3 X 12W LED Filament Made of: Opalflex® / Lentiflex® Cristalflex Fumé® With: Magnetic System® Weight: net Kg 5 - gross Kg 12,1 Package: A 160 x 32 x h.13 cm B 80 x 80 x h. 30 cm CB REPORT AVAILABLE		<input type="checkbox"/> BLACK <input type="checkbox"/> WHITE <input type="checkbox"/> PURPLE <input type="checkbox"/> FUMÉ	CLI78PST0000N_000 CLI78PST0000W_000 CLI78PST0000P_000 CLI78PST0000F_000

CLIZIA ENTIRE COLLECTION

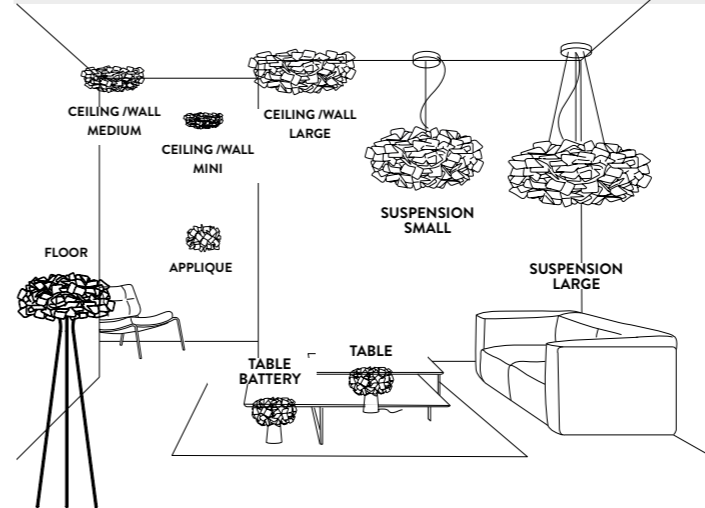

CERTIFICATION

CE IP 20

ENERGY CLASS: A / A+ / A++

ENERGY LABEL AVAILABLE ON SLAMP'S WEBSITE

FINISHES

