

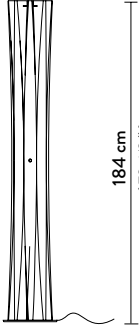







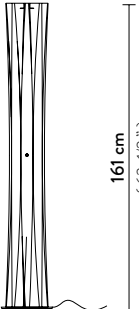

PRODUCT / PRODOTTO	DIMENSIONS / MISURE	COLOUR / COLORE	CODE / CODICE
FLOOR LAMP XXL Bulbs E27:  3 X12W LED Filament Dimmable with: Dimmable bulbs Made of: Opalflex® With: Stainless Steel base - Dimmer Weight: net Kg 4 - gross Kg 6,6 Package: 35 x 30 x h. 184 cm	 184 cm (72-1/2")  31,5 cm (12-1/2")	<input type="checkbox"/> WHITE	BAC42PFO0005W
		<input checked="" type="checkbox"/> GOLD	BAC42PFO0005O
FLOOR LAMP XL Bulbs E27:  3 X12W LED Filament Dimmable with: Dimmable bulbs Made of: Opalflex® With: Stainless Steel base - Dimmer Weight: net Kg 3 - gross Kg 6,2 Package: 30 x 35 x 170 cm CB REPORT AVAILABLE	 161 cm (63-1/2")  31,5 cm (12-1/2")	<input type="checkbox"/> WHITE	BAC42PFO0004W
		<input checked="" type="checkbox"/> GOLD	BAC42PFO0004O
FLOOR LAMP L Bulbs E27:  2 X12W LED Filament Made of: Opalflex® With: Stainless Steel base Weight: net Kg 2,56 - gross Kg 4 Package: 28 x 35 x h. 123 cm	 116 cm (45-1/2")  31,5 cm (12-1/2")	<input type="checkbox"/> WHITE	BAC42PFO0003W
		<input checked="" type="checkbox"/> GOLD	BAC42PFO0003O
TABLE LAMP M Bulbs E27:  1 X12W LED Filament Made of: Opalflex® With: Stainless Steel base Weight: net Kg 1,29 - gross Kg 1,9 Package: 25 x 24 x h. 76 cm	 73 cm (28-3/4")  21 cm (8-1/4")	<input type="checkbox"/> WHITE	BAC42TAV0002W
		<input checked="" type="checkbox"/> GOLD	BAC42TAV0002O

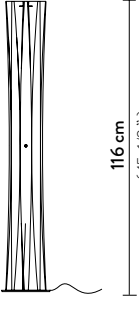
PRODUCT / PRODOTTO	DIMENSIONS / MISURE	COLOUR / COLORE	CODE / CODICE
TABLE LAMP S Bulbs E14:  1 X 6W LED Filament Dimmable with: Dimmable bulbs Made of: Opalflex® With: Stainless Steel base Weight: net Kg 0,58 - gross Kg 1 Package: 17 x 20 x h. 48 cm	 <p>42 cm (16-1/2")</p> <p>16 cm (6-1/4")</p>	<input type="checkbox"/> WHITE	BAC42TAV0001W
		<input type="checkbox"/> GOLD	BAC42TAV0001O

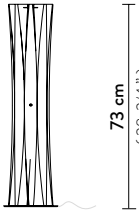
BACH ENTIRE COLLECTION

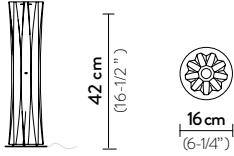
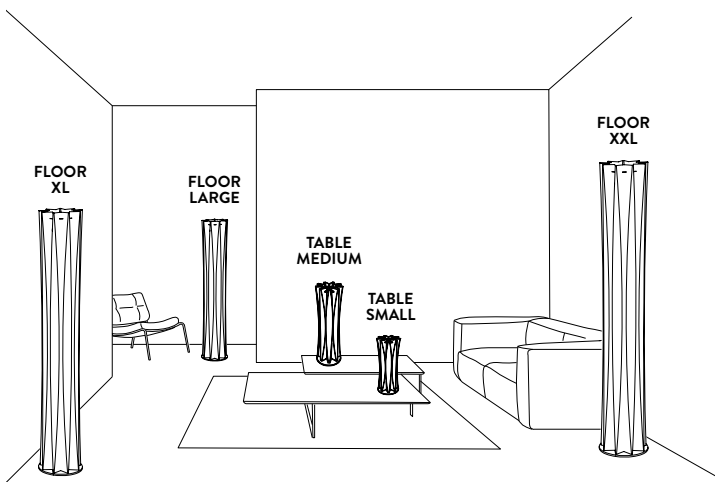

CERTIFICATION

CE IP 20 

ENERGY CLASS: A / A+ / A++
ENERGY LABEL AVAILABLE ON SLAMP'S WEBSITE

FINISHES



WHITE



GOLD