



OLO always originates from a circle or a line. Using the basic elements to create the picture of a light, Designer White challenges our every imagination by series that is designed to be limitless in possibilities.

Circular suspension conveys the nostalgic expression traced back to round table, which symbolizes "reunion" in traditional Chinese dining. Rotatable lamp shade embedded in cutting-edge design of hollow circles with glare-free LED lighting, the CRI 90 softened light can impressively create practical as well as ambient light. Occasionally light distribution is allowed due to rotatable structure of each shade. Upside or downward, let your imagination run loose and allow the fun to begin.

By Li, Hui Lun 李慧倫





copper



shiny black

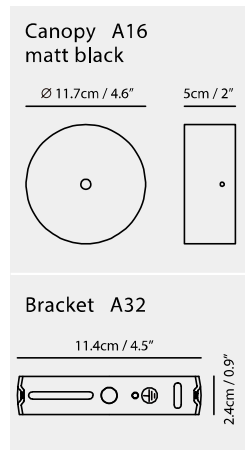
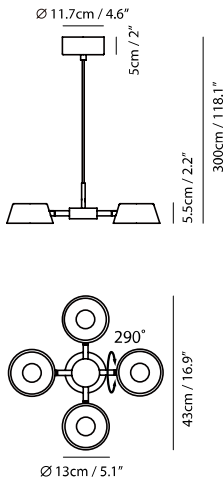

**OLO Pendant PC4**

**Model**

SLD-130PC4

**Material**

metal, aluminum, PP

**Light Source**

LED 4 x 6.5W 3000K CRI90 1400lm

**Driver**

Built-in dimmable driver (Triac dimming)

**Weight**

2.2kg / 4.9lb

**Color**

● matt black + copper shade

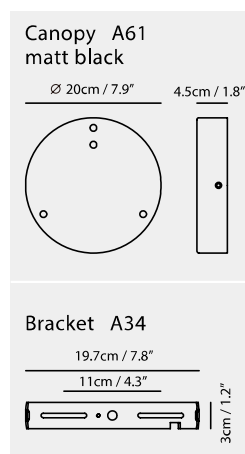
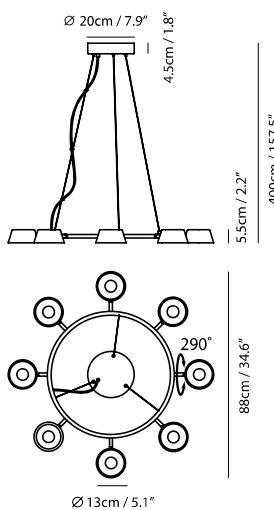
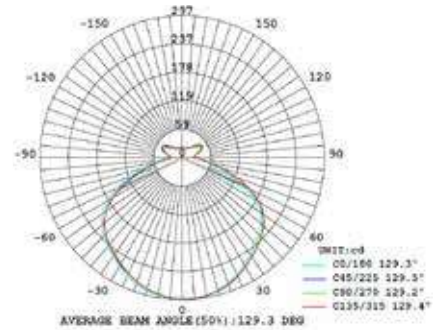

**OLO Pendant PC8**

**Model**

SLD-130PC8

**Material**

metal, aluminum, PP

**Light Source**

LED 8 x 6.5W 3000K CRI90 2530lm

**Driver**

Built-in dimmable driver (Triac dimming)

**Weight**

4.6kg / 10.1lb

**Color**

● matt black + shiny black shade

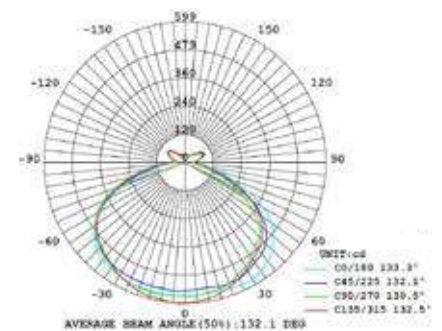



OLO always originates from a circle or a line. Using the basic elements to create the picture of a light, Designer White challenges our every imagination by series that is designed to be limitless in possibilities.

Rotatable lamp shade embedded in cutting-edge design of hollow circle with glare-free LED lighting, the CRI 90 softened light can impressively create practical as well as ambient light. With an easy one-touch-dimmer, you are one fingertip away to letting your imagination can run loose and allowing the fun to begin.

By Li, Hui Lun 李慧倫





matt black



champagne gold



copper



oatmeal

Measurement : centimeter / inches

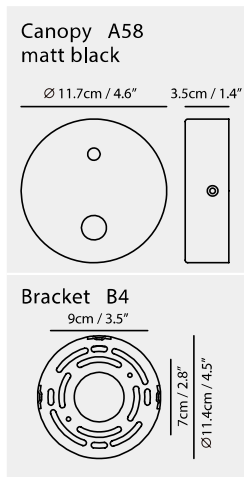
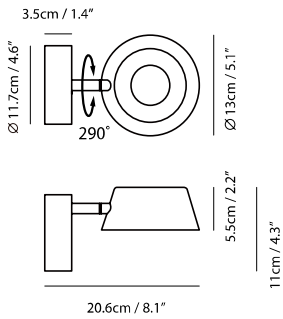

**OLO Wall**

**Model**  
SLD-130WRTE

**Material**  
metal, aluminum, PP

**Light Source**  
LED 6.5W 3000K CRI90 415lm

**Feature**  
Touch dimmer switch

**Weight**  
0.6kg / 1.3lb

**Color**

- matt black
- matt black + champagne gold shade
- matt black + copper shade
- oatmeal

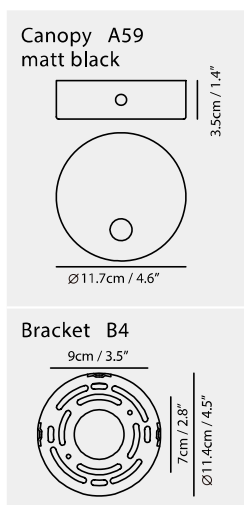
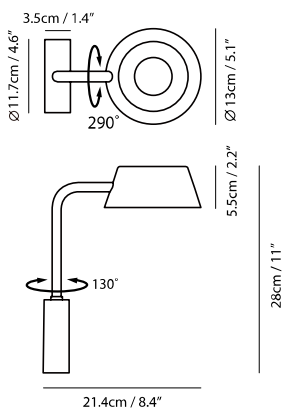
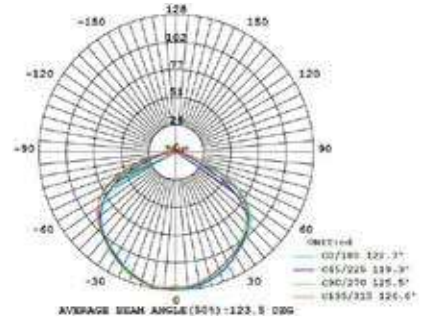

**OLO Wall WU**

**Model**  
SLD-130WUTE

**Material**  
metal, aluminum, PP

**Light Source**  
LED 6.5W 3000K CRI90 415lm

**Feature**  
Touch dimmer switch

**Weight**  
0.8kg / 1.7lb

**Color**

- matt black
- matt black + champagne gold shade
- matt black + copper shade
- matt black + oatmeal shade



The latest OLO appears in the form of table and floor lamps, with the ever-present simplicity and elegance of the silhouette, showing the purity of function and intention.

Originated from a circle or a line, OLO Uses the basic elements to create the picture of light. Designer White challenges our every imagination by series that are designed to be limitless in possibilities. Rotatable lamp shade embedded in cutting-edge design of hollow circles with glare-free LED lighting, the CRI 90 softened light can impressively create practical as well as ambience. Occasionally light distribution is allowed due to the rotatable structure of each shade. Upside or downward, let your imagination run wild and allow the fun to begin.

By Li, Hui Lun 李慧倫





matt black



champagne gold

Measurement : centimeter / inches

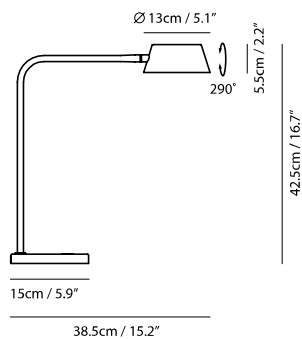

**OLO Table**

**Model**  
SLD-130DLTE

**Material**  
steel, PP

**Light Source**  
LED x 6.5W 3000K CRI>90 415lm

**Feature**  
Touch dimmer switch

**Weight**  
1.9kg / 4.2lb

**Cord**  
200cm / 78.7"

**Color**  
● matt black  
● matt black + champagne gold shade

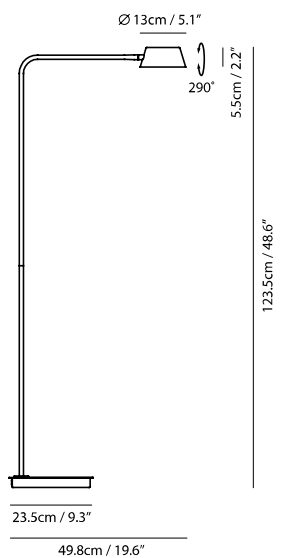

**OLO Table**

**Model**  
SLD-130DLTE

**Material**  
steel, PP

**Light Source**  
LED x 6.5W 3000K CRI>90 415lm

**Feature**  
Touch dimmer switch

**Weight**  
2.8kg / 6.2lb

**Cord**  
200cm / 78.7"

**Color**  
● matt black  
● matt black + champagne gold shade