

FOREVER
SCHONBEK

SEDUCTION
SJW4310

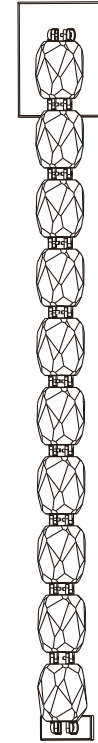

THIS DESIGN IS THE PROPRIETARY
TRADE DRESS/TRADEMARK OF
W SCHONBEK LLC.

FOREVER
SCHONBEK



All electrical components must be installed by a licensed electrician in accordance with the National Electric Code and the appropriate local electrical codes.

Fixture must be assembled per the provided instructions. Altering number of crystal modules may cause product failure and will void warranty.

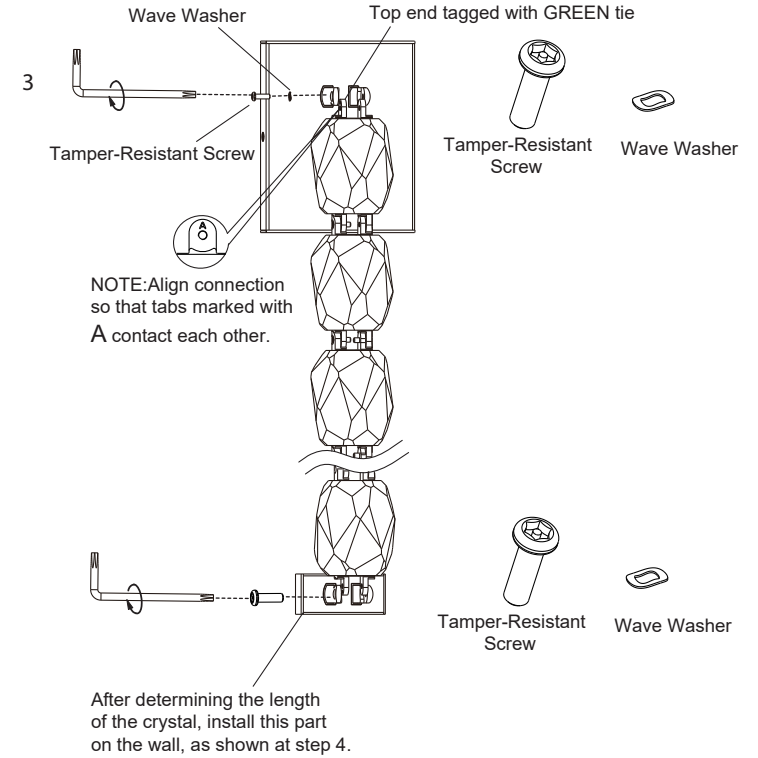
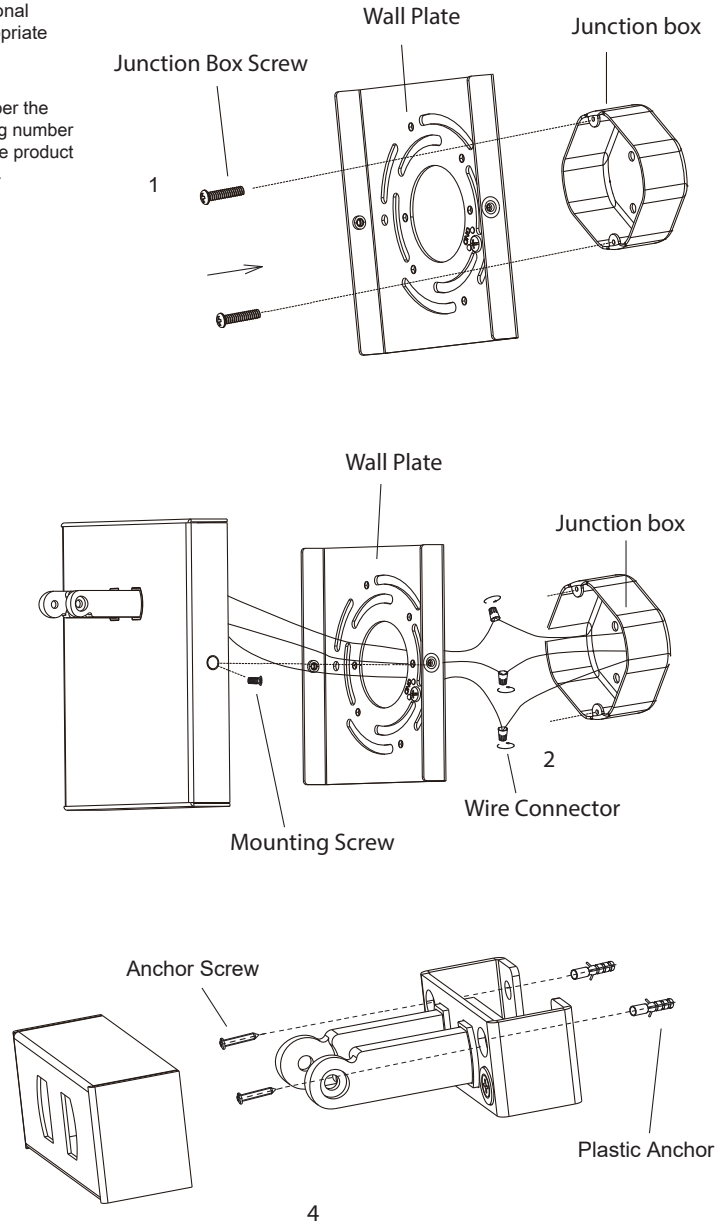

FULLY ASSEMBLE FIXTURE BEFORE TURNING ON POWER. TO ADJUST 3CCT SETTING, TURN OFF BEFORE ADJUSTING SWITCH.

