

# ASSEMBLY & INSTALLATION INSTRUCTIONS



## Fixture

WHISPER BFM75210

**Fig. 2 Wiring**

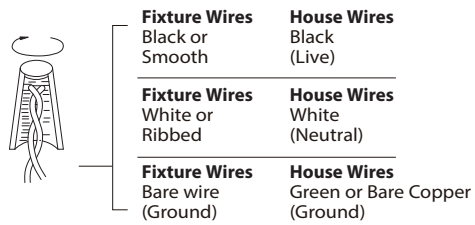

**Fig. 3 Switch**

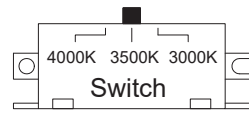

**Fig. 4**

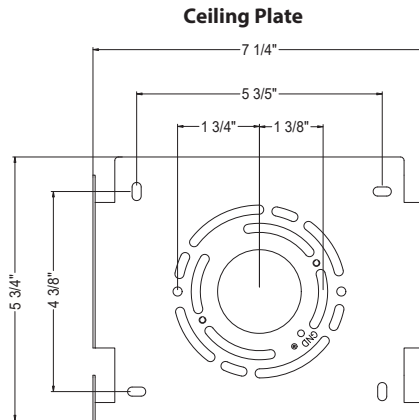
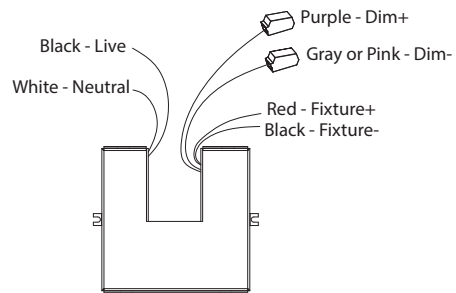

Schonbek, 61 Industrial Blvd, Plattsburgh, New York, 12901  
 Phone: 1-800-836-1892 | Fax: 518-563-4228 |  
[www.schonbek.com](http://www.schonbek.com)

## HARDWARE



Wire Connector  
Qty: 3pcs+1 Extra



Anti-Rotation Screw  
Qty: 1 Extra



Anchor Screw  
Qty: 4pcs+1 Extra



Plastic Anchor  
Qty: 4pcs+1 Extra

## ASSEMBLY & INSTALLATION INSTRUCTIONS

### Fixture

WHISPER BFM75210

SCHONBEK  
*Beyond*

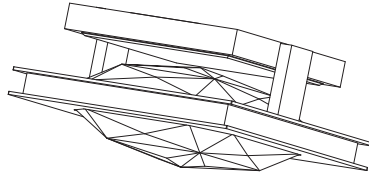
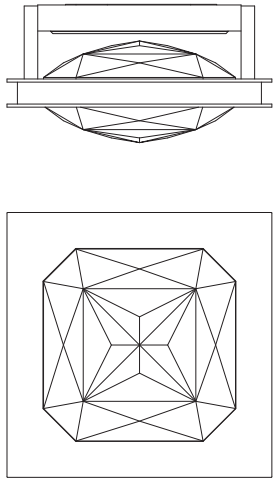

#### WARNING

- IMPORTANT: NEVER attempt any work without shutting off the electricity.
- Read all instructions before installing.
  - System is intended for installation in accordance with the National Electrical Code (NEC), other applicable installation code(s) and local regulations by a licensed electrician familiar with the operation of the product and the hazards involved.
  - Go to the main fuse box, or circuit breaker panel. Place the main power switch in the "OFF" position and unscrew the fuse (s) or switch "OFF" the circuit breaker switch (es) that control the power to the fixture (s) or room that you are working on.

- Place the wall switch in the "OFF" position.
- FAILURE TO INSTALL THIS FIXTURE IN ACCORDANCE WITH THESE INSTRUCTIONS MAY RESULT IN SERIOUS PERSONAL INJURY OR DEATH AND/OR PROPERTY DAMAGE.

#### CAUTION

- All parts must be used as indicated in these instructions. Do not substitute any parts, leave parts out, or use any parts that are worn out or broken. Failure to follow this instruction could invalidate the ETL/CETL Listing of this fixture.
- When handling the fixture, do not apply pressure to the LEDs or bulbs. Hold the fixture by the base only.
- Do not exceed maximum wattage noted on the fixture. Use only the recommended LED or standard lamps with the fixture.

#### ADVERTENCIA

- IMPORTANTE: NUNCA trate de hacer ningún trabajo sin desconectar la electricidad.
- Lea todas las instrucciones antes de instalar.
  - El sistema tiene por objeto la instalación de acuerdo con el Código Eléctrico Nacional, y otros códigos de instalación y reglamentos locales aplicables, por parte de un electricista autorizado que esté familiarizado con el funcionamiento del producto y los peligros involucrados.
  - Vaya a la caja de fusibles o al panel de disyuntores principal. Ponga el interruptor principal de alimentación en la posición de "APAGADO", y desenchufe los fusibles o "DESCONECTE" los disyuntores que controlen la alimentación a los dispositivos o la habitación en los que usted esté trabajando.
  - Ponga el interruptor de pared en la posición de "APAGADO".
  - EL HECHO DE NO INSTALAR ESTE DISPOSITIVO DE ACUERDO CON ESTAS INSTRUCCIONES PODRÍA RESULTAR EN UNA LESIÓN PERSONAL GRAVE O LA MUERTE, Y/O DAÑOS A LA PROPIEDAD.

#### PRECAUCIÓN

- Todas las piezas deben usarse como se indica en estas instrucciones. No sustituya ninguna pieza, no deje piezas fuera, ni utilice ninguna pieza que esté desgastada ni rota. El hecho de no seguir estas instrucciones podría invalidar la certificación ETL/CETL de este dispositivo.
- Al manipular el dispositivo, no aplique presión a los LED ni las bombillas. Sujete el dispositivo solo por la base.
  - No exceda la potencia máxima indicada en el dispositivo. Use solo los LED o las bombillas estándar recomendados con el dispositivo.

#### ADVERTENCIA

- IMPORTANTE: NUNCA trate de hacer ningún trabajo sin desconectar la electricidad.
- IMPORTANT: Ne JAMAIS entreprendre des travaux sans couper l'électricité.
- Lire toutes les instructions avant l'installation.
  - Ce système est conçu pour être installé conformément au Code national de l'électricité ou d'autres codes d'installation et réglementations locales en vigueur par un électricien agréé connaissant le fonctionnement de ce produit et les dangers qu'il comporte.
  - Aller à la boîte à fusibles ou panneau principal de disjoncteurs. Placer l'interrupteur d'alimentation principal sur « ARRÊT » et dévisser le ou les fusibles ou mettre sur « ARRÊT » le ou les disjoncteurs qui contrôlent l'alimentation du ou des appareils électriques ou de la pièce dans laquelle vous travaillez.
  - Mettre l'interrupteur mural sur « ARRÊT ».
  - NÉGLIGER D'INSTALLER CET APPAREIL CONFORMÉMENT À CES INSTRUCTIONS RISQUE D'ENTRAÎNER DE GRAVES BLESSURES PERSONNELLES OU LA MORT AINSI QUE DES DOMMAGES MATÉRIELS.
  - MISE EN GARDE
  - Toutes les pièces doivent être utilisées comme indiqué dans ces instructions. Ne remplacer aucune pièce, ne laisser aucune pièce de côté ou n'utiliser aucune pièce usée ou cassée. Le non-respect de cette directive peut invalider l'homologation ETL/CETL de cet appareil.
  - Lors de la manipulation de cet appareil, n'appliquer aucune pression sur les DEL ou les ampoules. Maintenir l'appareil par la base uniquement.
  - Ne pas dépasser le nombre de watts maximum indiqué sur l'appareil. N'utiliser que les DEL ou ampoules standard recommandées dans cet appareil.

## ASSEMBLY & INSTALLATION INSTRUCTIONS

### Fixture

WHISPER BFM75210

SCHONBEK  
*Beyond*

Fig. 1

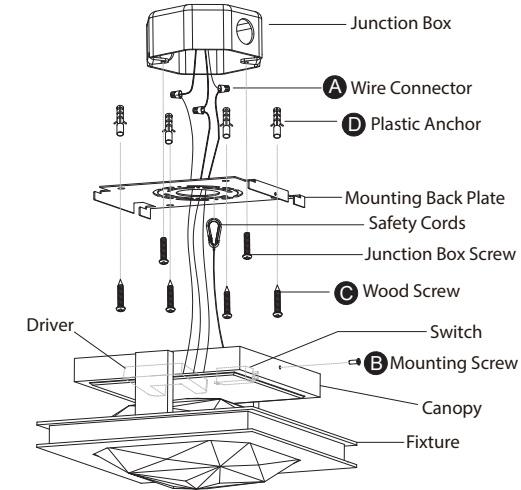

To Install Fixture (Fig. 1)

**CAUTION: BE SURE POWER IS OFF AT THE MAIN BREAKER BOX PRIOR TO INSTALLATION.**

#### PREPARATION

- Shut off the power at the circuit breaker and remove existing fixture, including the crossbar.
- Carefully unpack your new fixture and lay out all the parts on a clear area. Be careful not to lose any small parts necessary for installation.

#### MOUNTING CEILING PLATE (Fig. 1)

- Remove the anti-rotation screw (B) from the fixture, and remove the ceiling plate.
- Using the ceiling plate as a template, drill holes in the ceiling aligned with the outer set of 4 holes located in the ceiling plate.
- First, secure the ceiling plate to the junction box using the junction box screws (not provided). Second, fasten the ceiling plate to the ceiling using anchor screws (C).

Note: (i)The side of the ceiling plate marked "GND" must face out, towards the installer.

#### WIRING AND HANGING FIXTURE (Fig. 1, Fig. 2, Fig. 3)

- Set color temperature at this stage. The fixture can switch between three color temperatures (3000k, 3500k, 4000k), which can be adjusted to your preference using the 3CCT switch (Fig. 3) mounted in the fixture.
- Attach the fixture to the ceiling plate using a safety cable as shown (Fig. 1). This secures the fixture and aids in wiring.
- Connect the driver input/output wires to the junction box wires as shown in Fig. 2 using wire connectors (A) provided. Ensure wire connectors are secure. Connect the fixture's ground wire to the ground in the junction box; this will be either a green wire or a bare copper wire. After driver is wired to house wires, tuck wires carefully inside the junction box.
- If using a dimmer with this fixture, wire dimmer connections at this stage per section titled "(OPTIONAL) DIMMER WIRING."
- Mount the canopy against the ceiling plate. Secure fixture to the ceiling plate using the anti-rotation screw (B).

#### (OPTIONAL) DIMMER WIRING (Fig. 4)

- This fixture features electronic low voltage (ELV or TRAIC) or 0-10V dimming capabilities. See notes below for specific dimming wires information.
- To utilize ELV or TRAIC dimming: use wires black (live), white (neutral) and house green wire or bare copper wire (ground). Do not use dimmer wires on driver for ELV or TRAIC dimming.
- To utilize 0-10V dimming: use wires purple (dim+), Pink or gray (dim-) from driver and connect to corresponding wires in junction box.
- NOTE: Make sure to connect 0-10V prior to powering up the fixture in order to allow the 0-10V dimming to function properly.