

ASSEMBLY INSTRUCTIONS FOR YOUR AXIS 24" FLUSH MOUNT

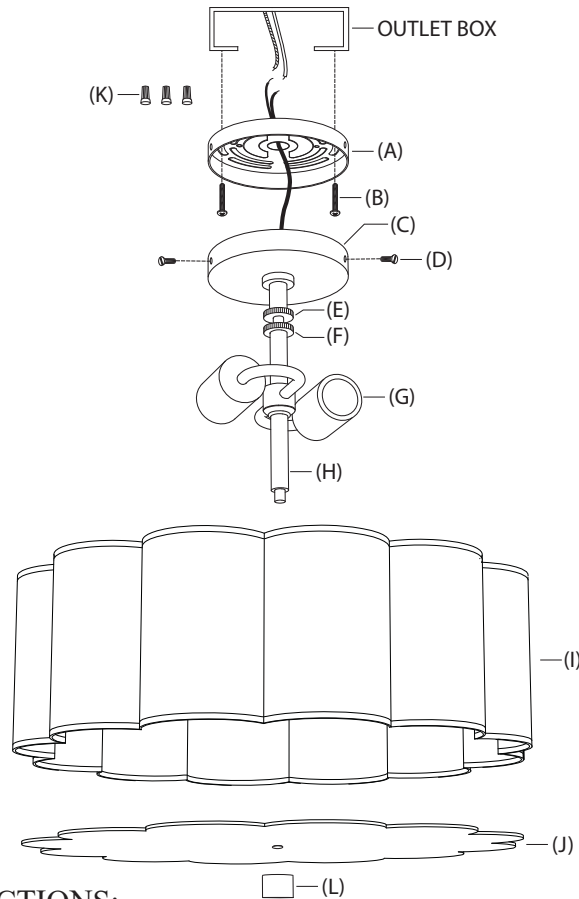

IMPORTANT SAFETY INSTRUCTIONS:

*These instructions are provided for your safety. It's important that they're read completely before beginning installation.

*WE STRONGLY RECOMMEND INSTALLATION BY A LICENSED ELECTRICIAN.

*Turn off power at switch before replacing bulbs, making sure fixture has had sufficient time to cool down.

ASSEMBLY INSTRUCTIONS:

1. SHUT OFF THE MAIN ELECTRICAL SUPPLY FROM THE MAIN FUSE BOX/ CIRCUIT BREAKER.
2. Remove all parts from carton, and remove all packing material. Do not throw away any parts.
3. Remove mounting plate (A) from canopy (C) by removing screws (D). Set screws (D) aside.
4. Carefully pull the wiring from the outlet box. Thread the wires through the center hole in mounting plate (A). Affix mounting plate (A) to ceiling outlet box with mounting screws (B) provided.
5. Lift fixture to mounting plate and make electrical connections described in steps 6 - 8. **A licensed electrician is recommended.**
6. Connect ground (green or silver in color) wire from fixture to ground wire in the outlet box. Fasten wires together with wire nut (K) and tightly wrap the connection with electrical tape.
7. Attach hot wire from fixture (black in color or smooth side of wire) to hot wire from outlet box. Fasten wires together with wire nut (K) and tightly wrap connection with electrical tape.
8. Attach neutral wire from fixture (white in color or ribbed side of wire) to neutral wire from outlet box. Fasten wires together with wire nut (K) and tightly wrap connection with electrical tape.
9. Carefully push wire connections back into outlet box. Slide canopy (C) over mounting plate (A), making sure holes are aligned.
10. Thread screws (D) into vacant holes along the sides of canopy (C) and mounting plate (A).
11. Lift shade (I) over bottom section of fixture. Slide split washer (located in the center of the shade frame) between shade washer (E) and shade washer (F). Secure position of shade by turning shade washer (E) clockwise until it rests firmly against the split washer.
12. Insert four 100W MAX Type A, medium base bulbs into sockets (G).
13. Remove finial (L) from threaded tube (H). Place diffuser (J) inside shade (I). Use finial (L) to secure diffuser to threaded tube (H).
14. Reconnect electrical supply at fuse box/circuit breaker and test fixture.

* To clean, use a soft cloth only. Do not use any chemical or abrasive cleaners. *