

# INSTALLATION INSTRUCTION

## 110 – LED Picture Lighting

PL-11017/PL-11025/PL-11033

# dweLED

**CAUTION: To prevent electrical shock, ensure electricity has been turned off at the circuit breaker before beginning.**

- Read all instructions before installing.
- System is intended for installation by a licensed electrician in accordance with the National Electrical Code (NEC) and local regulations.
- When handling the fixture, do not apply pressure to the LEDs. Hold the fixture by the base only.
- Retain installation instructions for future maintenance reference.

**WARNING:** All parts must be used as indicated in these instructions. This product is designed for use only with the supplied parts and/or accessories designated for use by dweLED. Substitution of parts or accessories not designated for use with this product by dweLED could result in personal injury or property damage, and will void the warranty. Contact an authorized dealer or the manufacturer if any parts are damaged or missing.

**MAINTENANCE NOTE:** Coastal conditions may cause mineral and residue build-up on the fixture. We recommend that customers in coastal areas clean all external surfaces of the fixture once every two weeks with a wet cloth.

**MISE EN GARDE:** Pour éviter tout choc électrique, assurez-vous que le disjoncteur soit mis hors tension avant de commencer.

- Lisez toutes les instructions avant l'installation.
- Le système doit être installé par un électricien licencié conformément au code national de l'électricité (NEC), et également aux règlements locaux.
- Lors de la manipulation du luminaire, n'appuyez pas sur les LED. Tenez-le uniquement par la base.

**ATTENTION:** Toutes les pièces doivent être utilisées comme indiqué dans ces instructions. Ce produit est conçu pour être utilisé seulement avec les pièces et/ou accessoires fournis pour être utilisés avec les produits dweLED. Remplacer des pièces ou accessoires non conçus pour ce produit dweLED pourrait causer des dommages corporels ou matériels et pourrait également causer l'annulation de la garantie. Veuillez contacter un revendeur autorisé ou le fabricant si des pièces manquent ou sont endommagées.

**NOTE D'ENTRETIEN:** Les conditions côtières peut causer une accumulation de minéraux et de résidus sur le luminaire. Nous recommandons aux clients qui résident dans les zones côtières de nettoyer toutes les surfaces externes du luminaire une fois toutes les deux semaines avec un chiffon humide.

## HARDWARE

A

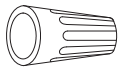

Wire Connector  
Qty: 3pcs+1 Extra

B



Mounting Screw  
Qty: 1pc Extra

C



Assembly Screw  
Qty: 2pcs+1 Extra

D

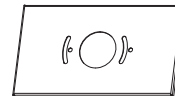

Conversion Plate  
Qty: 1 PC

E

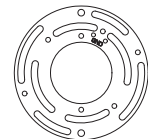

Mounting Ring  
Qty: 1 PC

dweLED.com  
Phone (800) 526.2588  
Fax (800) 526.2585

Headquarters/Eastern Distribution Center  
44 Harbor Park Drive  
Port Washington, NY 11050

Central Distribution Center  
1600 Distribution Ct  
Lithia Springs, GA 30122

Western Distribution Center  
1750 Archibald Avenue  
Ontario, CA 91760



**PREPARATION**

1. Shut off the power at the circuit breaker and remove existing fixture, including the crossbar.
2. Carefully unpack your new fixture and lay out all the parts on a clear area. Be careful not to lose any small parts necessary for installation.

**MOUNTING THE FIXTURE ON SWITCH BOX (Fig. 1)**

3. Remove the Mounting screw(B) from the fixture, and then remove the back plate.
4. Secure the mounting back plate to the switch box using standard junction box screws that comes with the junction box.

**Note:** (i) Using any other non-original-manufacturer provided junction box screw may result in safety issue;  
 (ii) The side of the mounting plate marked "GND" must face out.

**Fig.1 MOUNT ON SWITCH BOX**

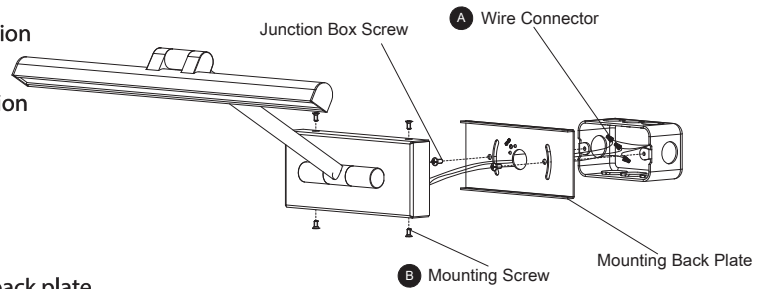

**OR**

**MOUNTING THE FIXTURE ON JUNCTION BOX (Fig. 2)**

3. Remove the Mounting screw(B) from the fixture, and then remove the back plate.
4. Secure the Mounting Ring(E) to the junction box using the junction box screw. The side of the mounting ring marked "GND" must face out.
5. Secure the mounting back plate and conversion plate (D) to the mounting ring with the Assembly screws (C).

**Fig.2 MOUNT ON JUNCTION BOX**

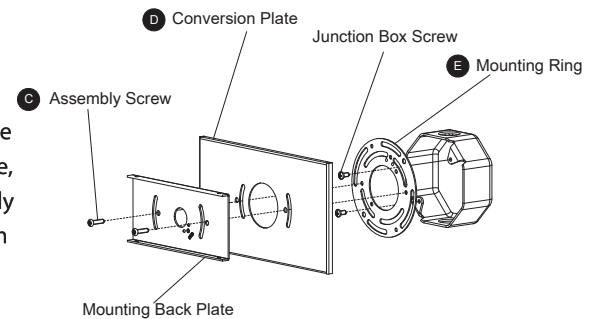

**CONNECTING THE WIRES (Fig. 3)**

6. Connect the driver wire to junction box wires as shown in Fig. 3, making sure that all wire connectors (A) are secured. If your outlet box has a green or bare copper ground wire, connect the fixture's ground wire to it. Otherwise, connect the fixture's ground wire directly to the back plate using the green screw provided. After wires are connected, tuck them carefully inside the switch box.
7. Secure the fixture onto mounting place with Mounting screw (B).

**Fig.4**

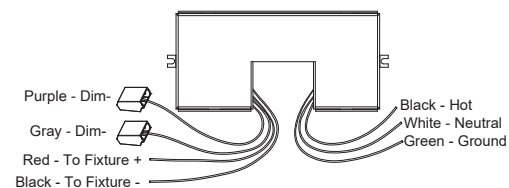

**DIMMING WIRING INFORMATION (Fig. 4)**

8. This fixture features electronic low voltage (ELV or TRAIC) or 0-10V dimming capabilities. See notes below for specific dimming wires information.
9. To utilize ELV or TRAIC dimming: use wires black (hot), white (neutral) and bare copper ground wire (ground).
10. To utilize 0-10V dimming: use wire purple (dim+), gray (dim-), black (hot), white (neutral) and bare copper ground wire (ground).

NOTE: Make sure to connect 0-10V prior to power-up the fixture in order to allow the 0-10V dimming to function properly.

**Fig.3 Wiring**

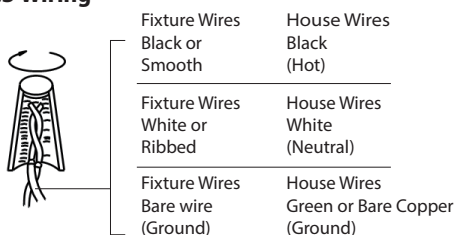

**Conversion Plate Dimensions**

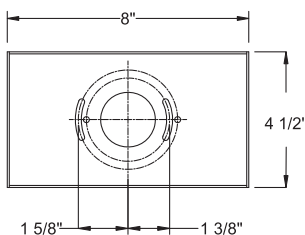

**Mounting Ring Dimensions**

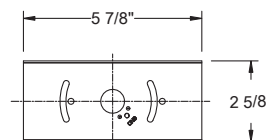

**Mounting Ring Dimensions**

