

# Safety & Installation Instructions

v1.2-05.19

ENG WARNING – RISK OF FIRE AND ELECTRIC SHOCK. THIS PRODUCT IS BEST INSTALLED BY A QUALIFIED ELECTRICIAN.

INSTALL IN ACCORDANCE WITH CURRENT NEC WIRING REGULATIONS.

SUITABLE FOR DRY LOCATIONS ONLY

TURN OFF POWER AT THE MAIN FUSE BEFORE COMMENCING INSTALLATION.

FR ATTENTION – RISQUE D'INCENDIE, RISQUE DE CHOC.

CE PRODUIT DOIT ÊTRE INSTALLÉ SELON LE CODE D'INSTALLATION PERTINENT, PAR UNE PERSONNE QUI CONNAÎT

BIEN LE PRODUIT ET SON FONCTIONNEMENT AINSI QUE LES RISQUES INHÉRENTS.

POUR EMBLACEMENTS SECS SEULEMENT

COUPEZ LE FUSIBLE PRINCIPAL AVANT DE COMMENCER L'INSTALLATION.

1. Prepare the fitting for installation- consulting the instructions and diagrams on the inside page. Once desired drop of pendant is established, the cable length may be shortened. If cable is desired length already, then skip to instruction point number 3.
2. To shorten cable:-
  - a. Establish required length of cable (ensuring there is some slack) before using wire cutters to cut.
  - b. Remove the outer insulation from the last 6" of the end of the cable, then remove the last 1/4" of inner sleeving from both cables to expose the wire.
  - c. Make sure that when stripping the outer cable no damage occurs to the interior cable.
3. This fitting should be installed on a 4" junction box (not supplied).
4. Open your existing junction box (if you do not have one in the desired position you will need to get an electrician to install one). If removing an existing fitting first, note all wiring connections: record which of the house wires is connected to the live, neutral and earth (ground) terminals.
5. Attach the fixing plate to your junction box using the two existing bolts.
6. In your junction box there should be two supply wires and one ground wire. Connect your new lamp to the electrical supply using UL approved wire nuts. Connect the live (hot) black wire from the power supply to the black conductor on the luminaire cable, then the white (neutral) wire to the white conductor on the luminaire cable and bare copper or green/yellow ground wire should be terminated inside the junction box (do not connect to fitting).

## KEY

L = Live (hot)  
N = Neutral  
⊕ = Earth (ground)

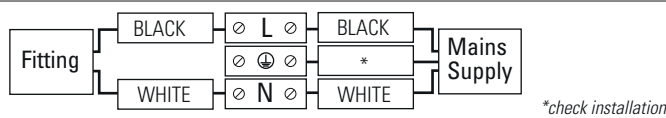

7. Support the fitting so that no strain is applied to the wiring when making the electrical connections. If necessary get a colleague to help.
8. See hanging instructions inside to complete the installation.
9. Fit the correct type and wattage of lamp (or less). Be careful not to overtighten the lamp.
10. Switch on at the fuse-board. Your light fitting is now ready for use.

## Other Important Information

Switch off at mains before changing lamp(s). Never fit a lamp of greater wattage than recommended. Ensure children do not play with the light fitting. Dispose of old lamps carefully. Never leave a fitting without a lamp in position (or someone can accidentally touch the contacts). Adjust fitting only when power to the fitting is off and has been left to cool. If the electrical flex or electrical components become damaged at any point, power to the fitting should be disconnected immediately and not operated until the damaged parts are fixed/replaced. For use in dry, indoor environment only. Ensure the fitting does not come into contact with any liquids.

## Cleaning and Maintenance

Metal finishes should only be cleaned with a soft, dry cloth. Do not use polishes or abrasives. Bone china can be cleaned using a soft damp cloth or with a suitable mild (non-abrasive) detergent. Switch off power to the fitting before cleaning.

Established in 1990, Original BTC manufactures relaxed, familiar lighting for traditional and contemporary homes.

All products are hand-assembled in Oxford from high quality components, produced in the UK.

ORIGINALBTC.COM

+44 (0)1993 882 251

UNIT 21 / 22 AVENUE ONE, STATION LANE, WITNEY, OX28 4XZ, ENGLAND



# Fin Medium, Large, Extra Large & Horizontal Pendant Lights Instruction Manual

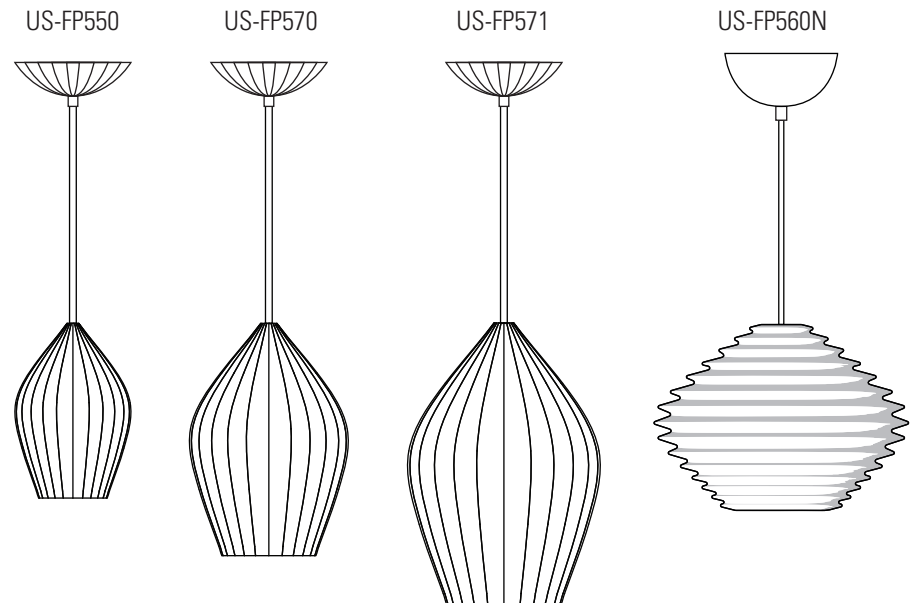

**ORIGINAL BTC**  
BRITISH LIGHTING MANUFACTURERS  
LONDON • NEW YORK • PARIS





# Fin Pendant Lights

| 120V ac 60Hz | IP20

US-FP550	Fin Medium
US-FP570	Fin Large
US-FP571	Fin Extra Large
US-FP560N	Fin Horizontal

The Fin pendant accentuates the translucent properties of bone china, creating a beautiful lit effect through its unique organic form.

LAMP GUIDANCE						
BASE	SHAPE	TYPE*	WATTAGE**			
 E26	 A	 BALL	INCANDESCENT	✓	FP550	FP570, FP571 & FP560N
			CFL	✓	40W MAX	60W MAX
			ECO-HALOGEN	✓	11W	13W
			LED	✓	28W	42W
					6W	9W

\* Warm white (2700k) low energy lamps recommended.  
 \*\* Wattage value provided as a guide to suitable lamps. Lower wattage than stated may be used.

## Contents

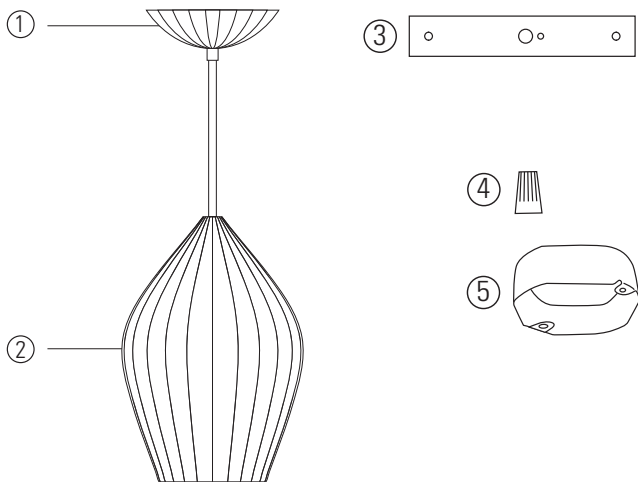

### Contents

- 1 - Ceiling Rose
- 2 - Shade
- 3 - Bracket

### Tools/Hardware Required

- 4 - 3 x UL Wire Nuts
- 5 - Junction Box

Screwdriver

PLEASE READ THE INSTRUCTIONS ON THE REVERSE BEFORE YOU BEGIN INSTALLING YOUR LIGHT

## Installation Diagram

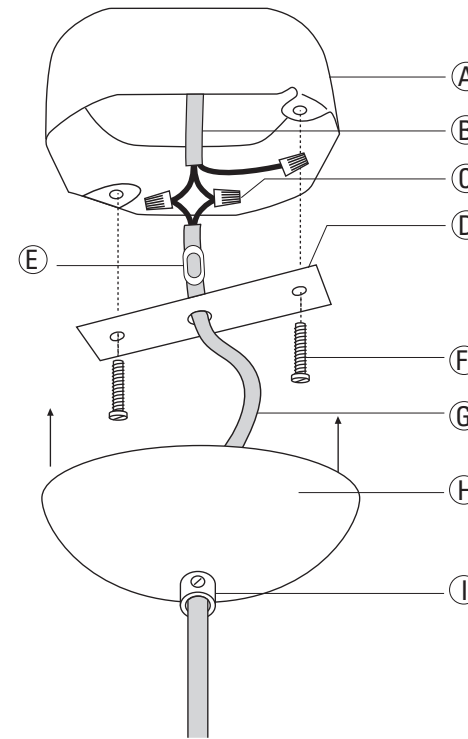

### Key

- A Junction Box\*
- B Main Supply
- C Wire Nuts\*
- D Mounting Bracket
- E Cord Restraint
- F Junction Box Screws\*
- G Luminaire Cable
- H Ceiling Rose
- I Cord Grip
- \*not supplied

## Hanging Instructions

This product is made from Fine Bone China; take care when handling this product during installation.

Refer to diagram above.

### STEP 1

Determine the required drop of the fitting and adjust luminaire cable (G) length as necessary - see point 2 overleaf.

### STEP 2

Screw the mounting bracket (D) to the junction box using existing screws.

### STEP 3

Make connection to the mains supply (follow instructions overleaf), using suitable wire nuts.

### STEP 4

Push the ceiling rose (I) until it is flush with the ceiling. Tighten the grub screw on the cord grip (J), taking care not to overtighten as this can damage the luminaire.