

m o o o i

Serpentine Light 8

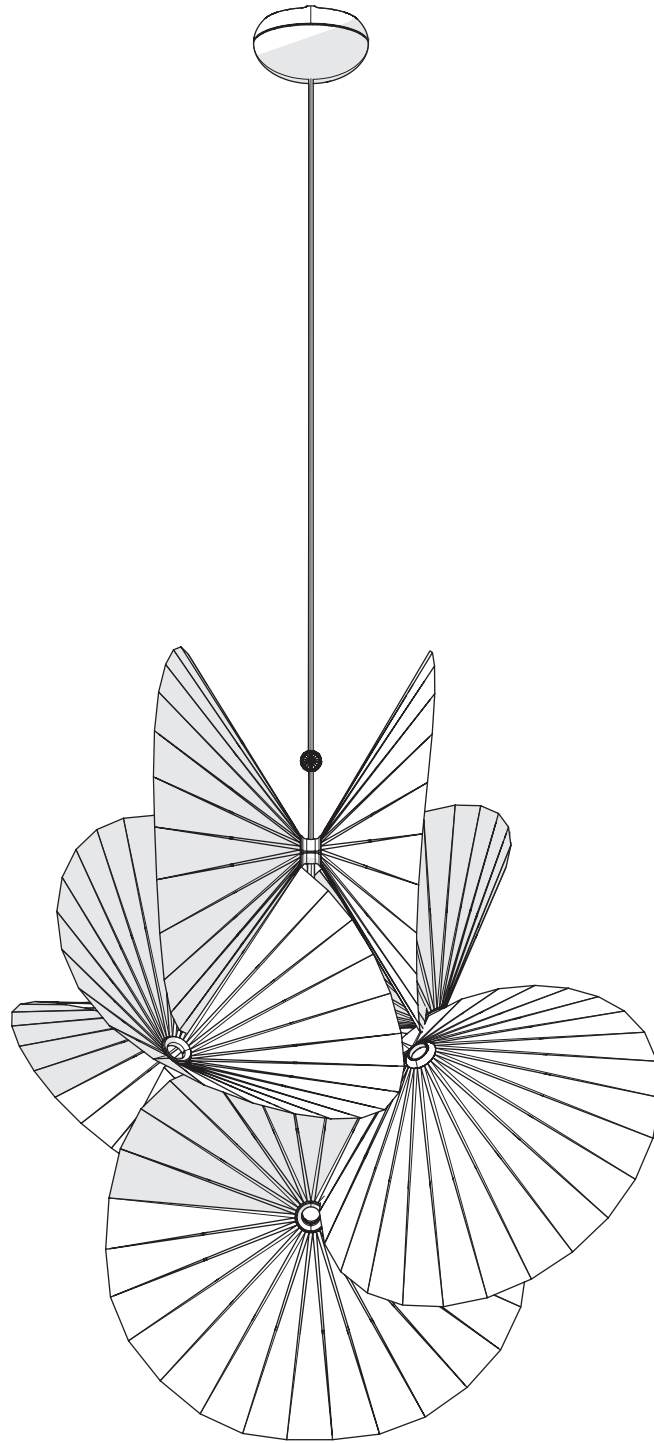

visit www.mooui.com for more information about the collection

moooi

Serpentine Light 8

i



PLEASE HANDLE THIS PRODUCT WITH CARE.
NEVER PLACE THE LAMP ON THE GROUND. THIS MAY DAMAGE THE
PRODUCT.

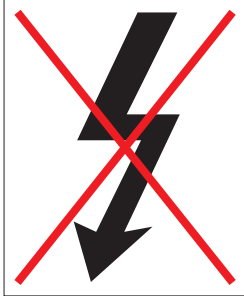

NOT INCLUDED

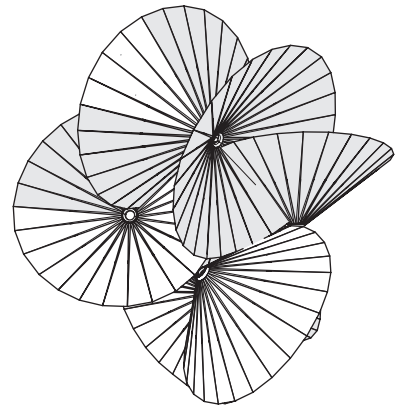
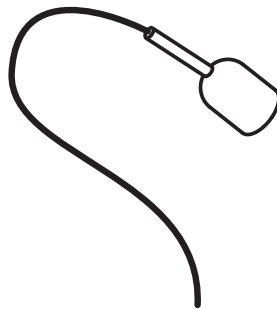
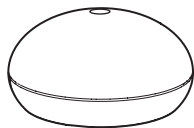
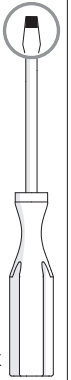
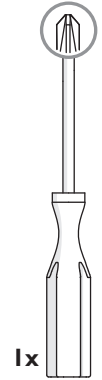
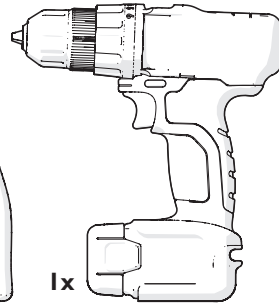
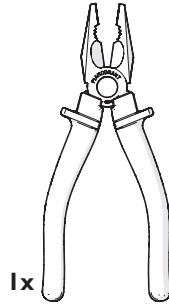

I

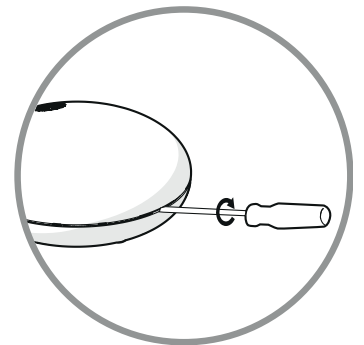
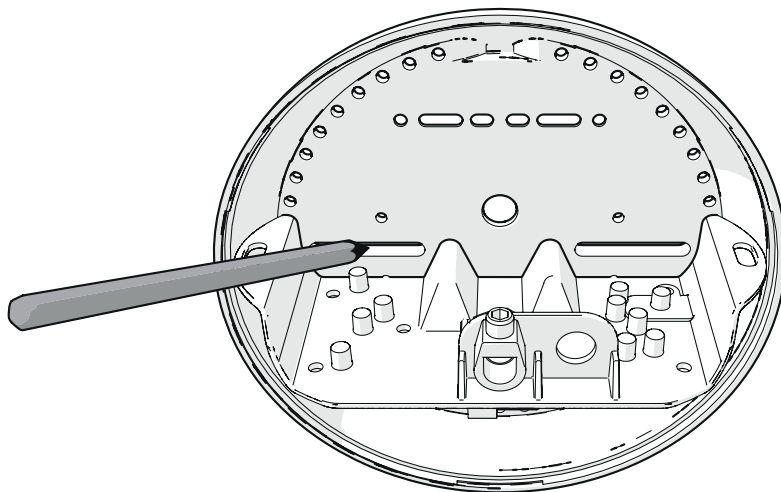

visit www.moooi.com for more information about the collection

m o o o i

Serpentine Light 8

2

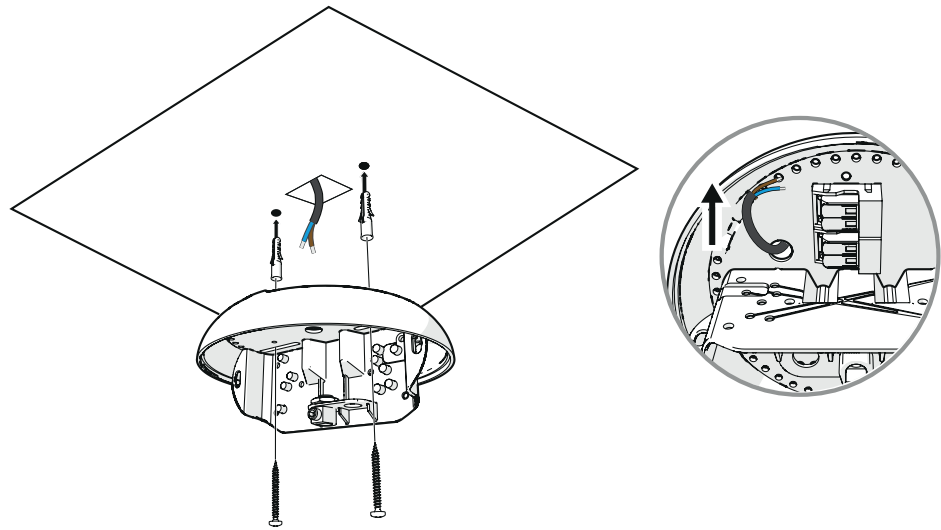

3

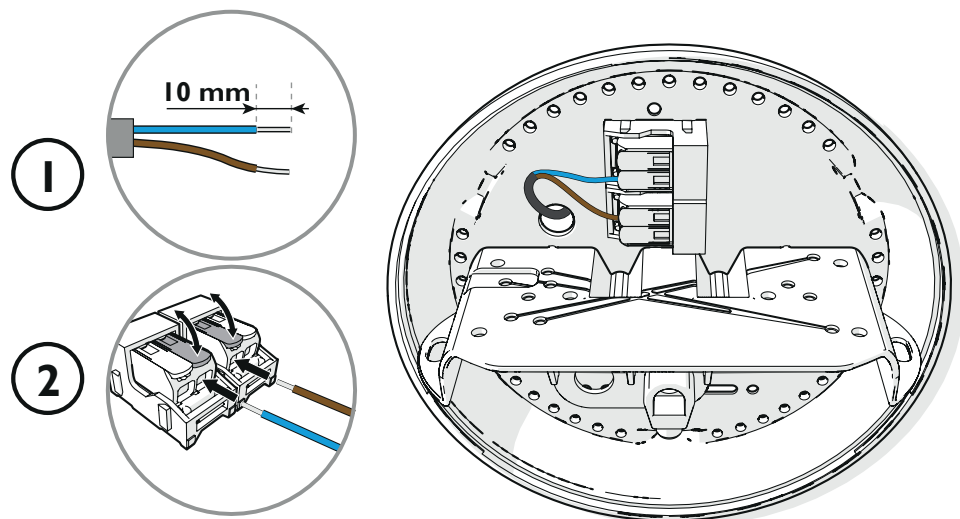

4

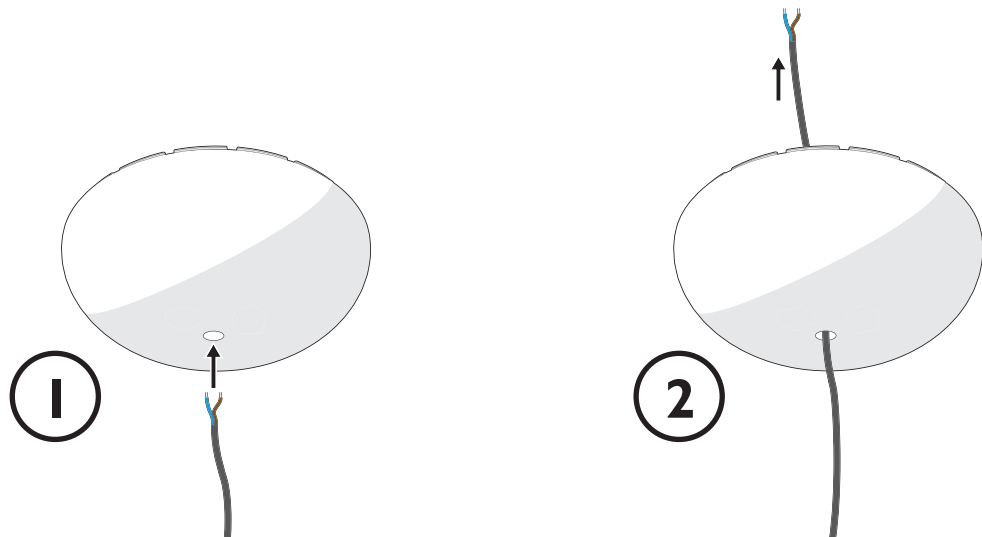

visit www.mooui.com for more information about the collection

moooi

Serpentine Light 8

5

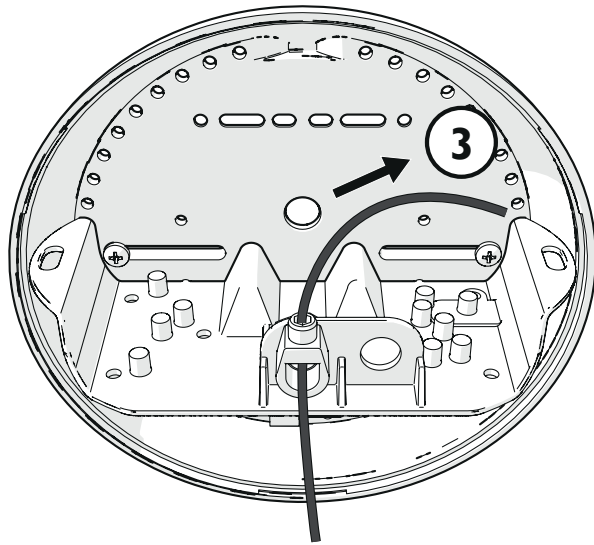

6

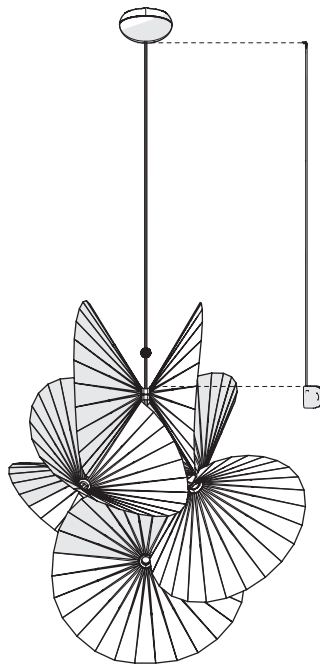

7

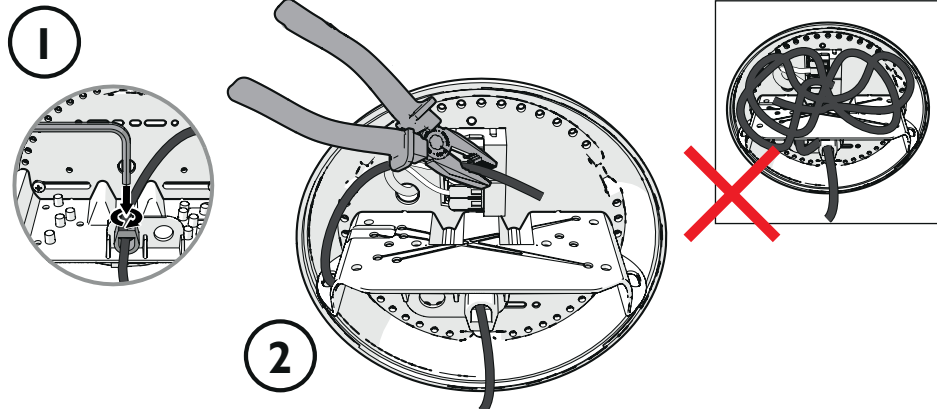

visit www.moooi.com for more information about the collection

m o o o i

Serpentine Light 8

8

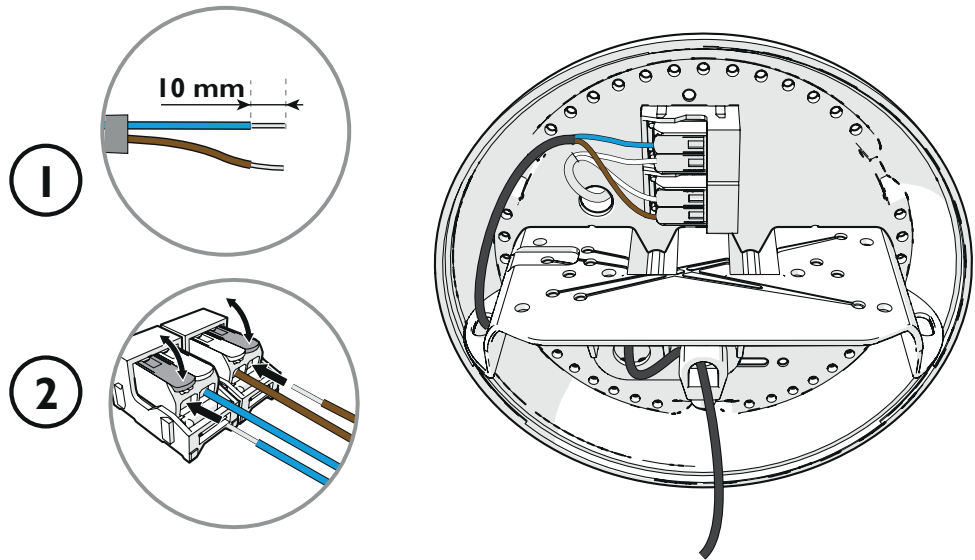

9

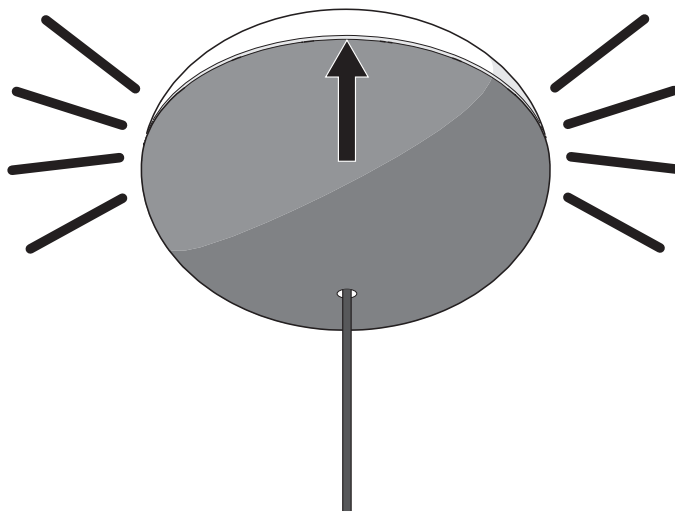

10

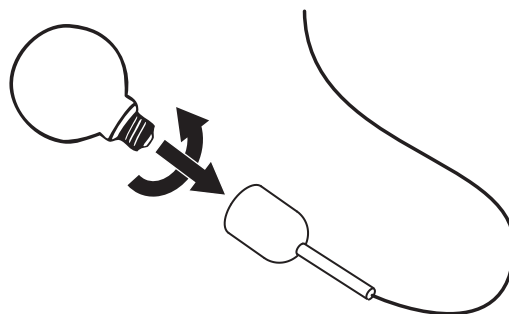

m o o o i

Serpentine Light 8

11

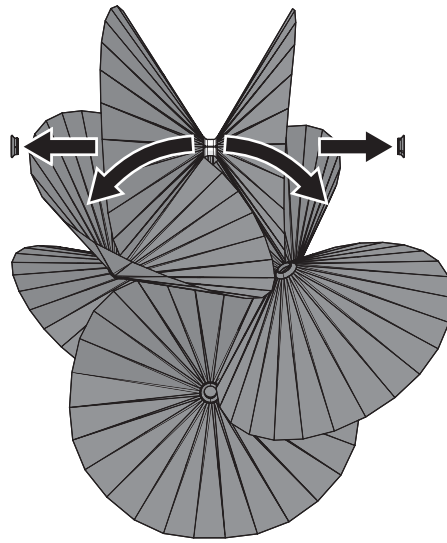

12

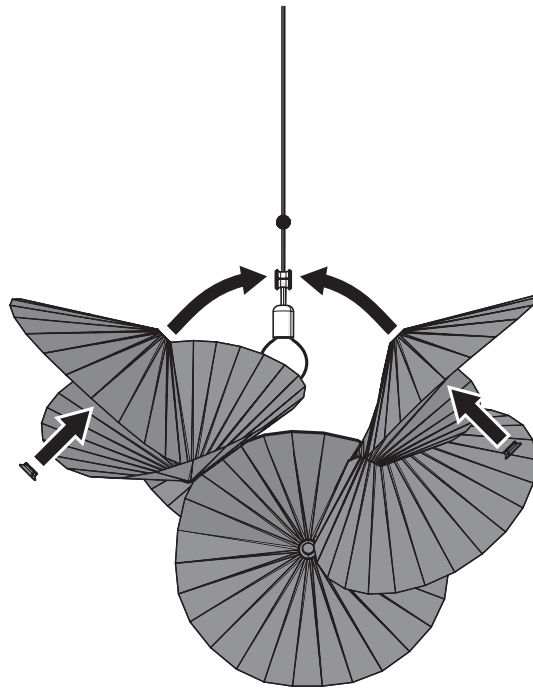

i

1

WWW.MOOOI.COM/
THE-BUTTON

2

SCAN AND REGISTER
扫描并注册

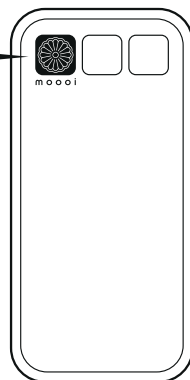

visit www.moooi.com for more information about the collection

m o o o i

Serpentine Light 8

i

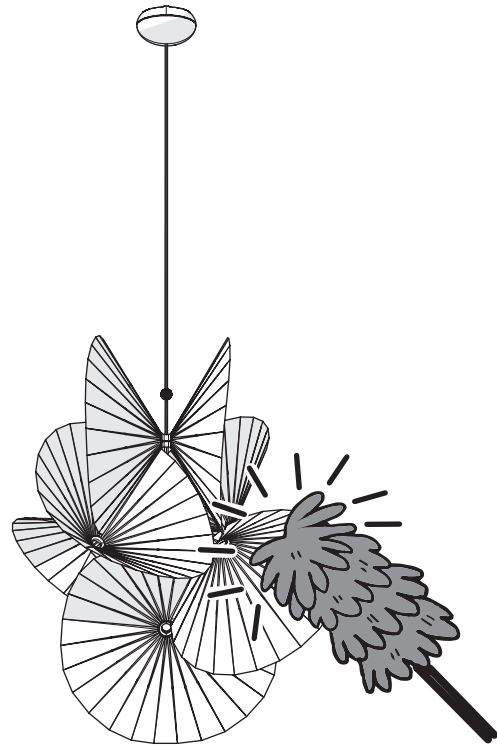

m o o o i

CAN ICES-005

THIS DEVICE COMPLIES WITH PART 15 OF THE FCC RULES.
OPERATION IS SUBJECT TO THE FOLLOWING TWO CONDITIONS:

- (1) THIS DEVICE MAY NOT CAUSE HARMFUL INTERFERENCE, AND
- (2) THIS DEVICE MUST ACCEPT ANY INTERFERENCE RECEIVED,
INCLUDING INTERFERENCE THAT MAY CAUSE UNDESIRE
OPERATION

MOOOI B.V.

MINERVUM 7003
BREDA
THE NETHERLANDS



Thank you!