

MONTE CARLO

CEILING FAN COMPANY

ESSWC-8-WH WALL TRANSMITTER INSTALLATION AND OPERATION INSTRUCTION



SAFETY INFORMATION AND GENERAL GUIDE

READ AND SAVE THESE INSTRUCTIONS

- Please read and understand this entire manual before attempting to assemble, install or operate the product.
- Make sure that all electrical connections comply with local codes, ordinances, the National Electrical Code and ANSI/NFPA 70. Hire a qualified electrician or consult a do-it-yourself wiring handbook if you are unfamiliar with installing electrical wiring.

Warning: Before proceeding, be sure to shut off electricity at main switch or circuit breaker in order to avoid electrical shock.

Note: Fan installation must be complete including assembly of blades before testing wall control unit.

Note: Refer to your Ceiling fan instruction manual for Safety and installation instruction.

This wall controller is to be used for the control of ceiling fan and fan light only.

Warning: Do not exceed maximum rating of the wall transmitter. Install the wall transmitter away from excess heat or humidity

Customer Service
800-969-3347

Customer Service Center
7400 Linder Ave.
Skokie, IL 60077
www.montecarlofans.com





Wall Transmitter Installation, Wiring and Setting

Warning: Before proceeding, be sure to shut off electricity at main switch or circuit breaker in order to avoid electrical shock.

Note: Before installing the wall transmitter, place the ON/OFF switch in OFF position by pushing ON/OFF switch to the OFF.

Make series-wound connection for the wall transmitter with HOT wire from house. Connect a black wire from wall transmitter to the HOT wire and then connect the other wire to the LOAD wire in outlet box from fan.

Note: The ON/OFF switch is to turn the power of fan on/off. If you have installed a wall switch to control the power of fan, you may keep the 2 black wires from the wall transmitter free and isolate them.

Connect green grounded wire to grounded wire from outlet box. (Fig. 1)

Install the Bracket and Wall transmitter to outlet box using machine screws provided. (Fig. 2)

Install battery, remove switch cover by finger or using a small pointed object and place batteries as shown in **figure 3**. Use 2 1.5V/AAA batteries. The battery will weaken with age and should be replaced before leaking as this will damage the transmitter. Dispose of used battery properly, keep the battery out of reach for children.

Inset the wall plate onto the bracket. (Fig. 2)

Note: Place the wall transmitter in ON position when operating the fan.

Universal Mode and Learning Mode

Remove wall plate and switch cover by finger or using a small pointed object as shown in figure 3. If wall plate has been installed, remove it so as to pry the switch cover open.

There are “Universal Mode” and “Learning Mode” with the remote controller.

If choosing “**Universal Mode**”, simply place both dip (code) switch at UPPER position. Your fan with the remote controller is ready to use. (Fig. 3)

Note: If using universal mode, your fan can be controlled with other remote transmitters with the same setting.

To control the fan with specific remote transmitter, choose “**Learning Mode**” by placing the dip (code) switch at LOWER position and then make learn function setting as below.

Make “**Learn function setting**”, Restore power source to your fan, press and hold the “SET” button for about 4 seconds until buzzer inside receiver sounds. Your remote controller is ready to operate the fan. You must press the “SET” button within 1 minute of restoring power to the fan. (Fig.3)

Note: If the power is on already, you must turn the power off for at least 5 seconds and then turn the power back. Wait for **6 seconds** at least then make learn function setting. If the fan is running after turn power back, still wait for at least 6 seconds and then press and hold the “SET” button for about 4 seconds until buzzer inside receiver sounds. Your remote controller is ready to operate the fan.

Note: If you want to control a fan with 2 transmitters (Wall mount or hand-held transmitter, turn the power off for at least 5 seconds and then turn the power back and wait for at least **6 seconds** for learn function setting. Setting for both transmitters must be done within 1 minute of restoring power to the fan. A fan can be controlled by 2 transmitters maximum when choose Learning Mode.

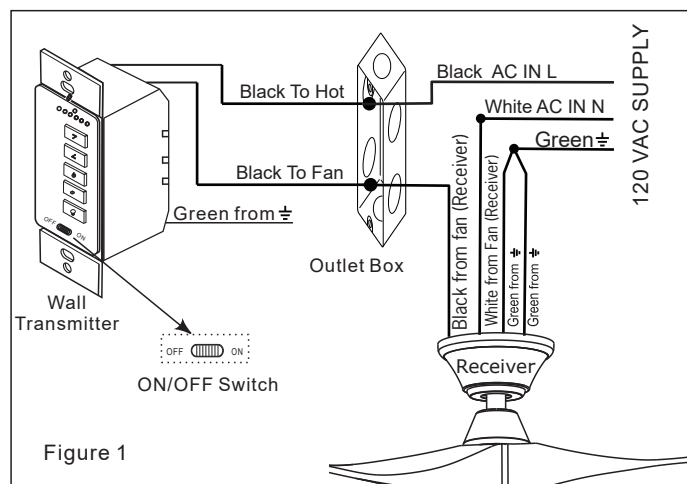

Figure 1

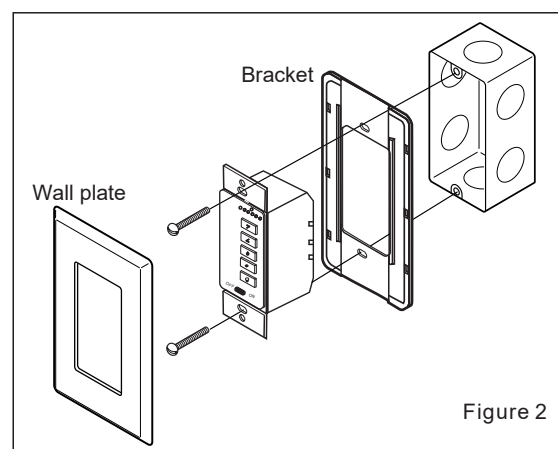

Figure 2

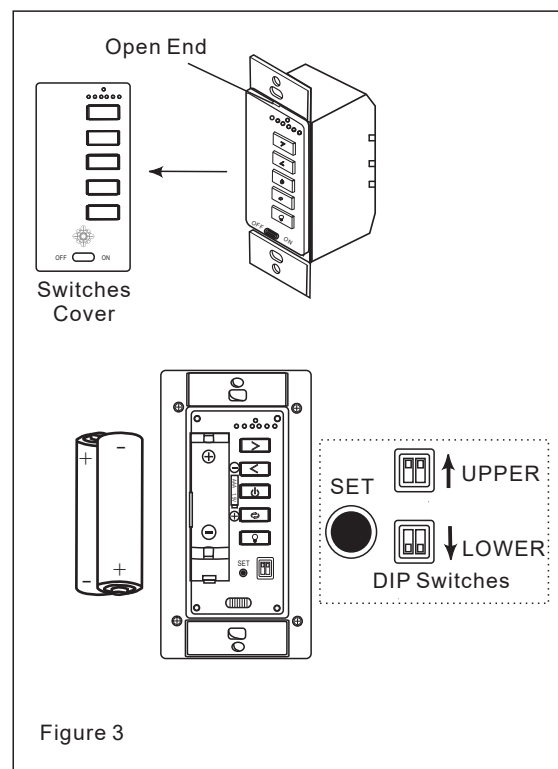







Figure 3



WALL TRANSMITTER OPERATION

The buttons on the wall transmitter control the fan speed and light as follows.

(Fig. 4)

-  Press the button to get desired fan speed, Low to High.
-  Press the button to get desired fan speed, High to Low.
-  Press the OFF button to turn fan off.
-  Press this forward/reverse button to get desired airflow direction. Fan must be running to reverse. It will take about 25 seconds for fan to slow down and change rotation direction.
-  Press this button quickly to turn light on or off. To dim light, hold down the button, the light will cycle from bright to dim to bright until button is released.

 Slide ON \ OFF switch to turn power on or off.

Note: Fan and Light will maintain last setting if turned power off by the ON/OFF switch.

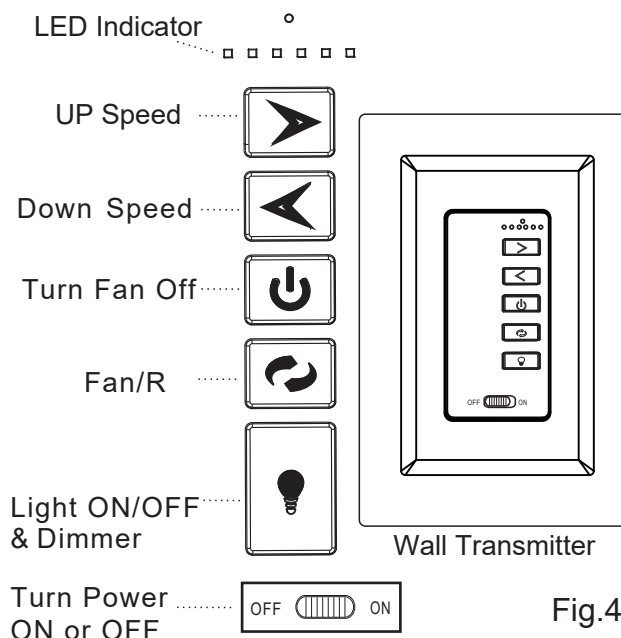

Fig.4

Tips for end users

1. If your fan is operated automatically after installation and power on, it is because your fan is still memorize the previous setting at factory. Use universal mode or make learn function setting and your fan will be ready for use.
2. If fan or light isn't working, reset power (turn the power off for at least 5 seconds, then turn the power back, and wait for 5 seconds at least) and redo the learn function setting. You must press the "SET" button within 1 minute of restoring power to the fan.
3. It is not available to separately operate the remote setting for more than one fan in the same room (in the area where remote signal can reach to) if they share the same power supply. Separate power supplies (like as using individual wall switches for each fan and turn power off for the fan while you are making learn function for other fan) is required if you want to separately control more than one fan in same room.
4. You may erase the code setting of the transmitters by turn the power off for at least 5 seconds, then turn power back and wait for at least 5 seconds then push and hold the "OFF" button of the transmitter which you are using for at least 10 seconds. You must press the "OFF" button within 60 seconds of restoring power to the fan.
5. When fan is turned on or operated forward/reverse function, it shutters & goes back & forth until it turns. It is a normal performance of this fan and it will take for few seconds to run this operation.

THIS DEVICE COMPLIES WITH PART 15 OF THE FCC RULES OPERATION IS SUBJECT TO THE FOLLOWING TWO CONDITIONS. (1)THIS DEVICE MAY NOT CAUSE HARMFUL INTERFERENCE AND (2) THIS DEVICE MUST ACCEPT ANY INTERFERENCE RECEIVED, INCLUDING INTERFERENCE THAT MAY CAUSE UNDESIRE OPERATION.

Jul.2019