

MONTE CARLO

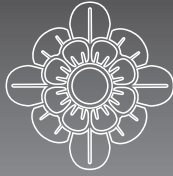

CEILING FAN COMPANY

Owner's Guide and Installation Manual

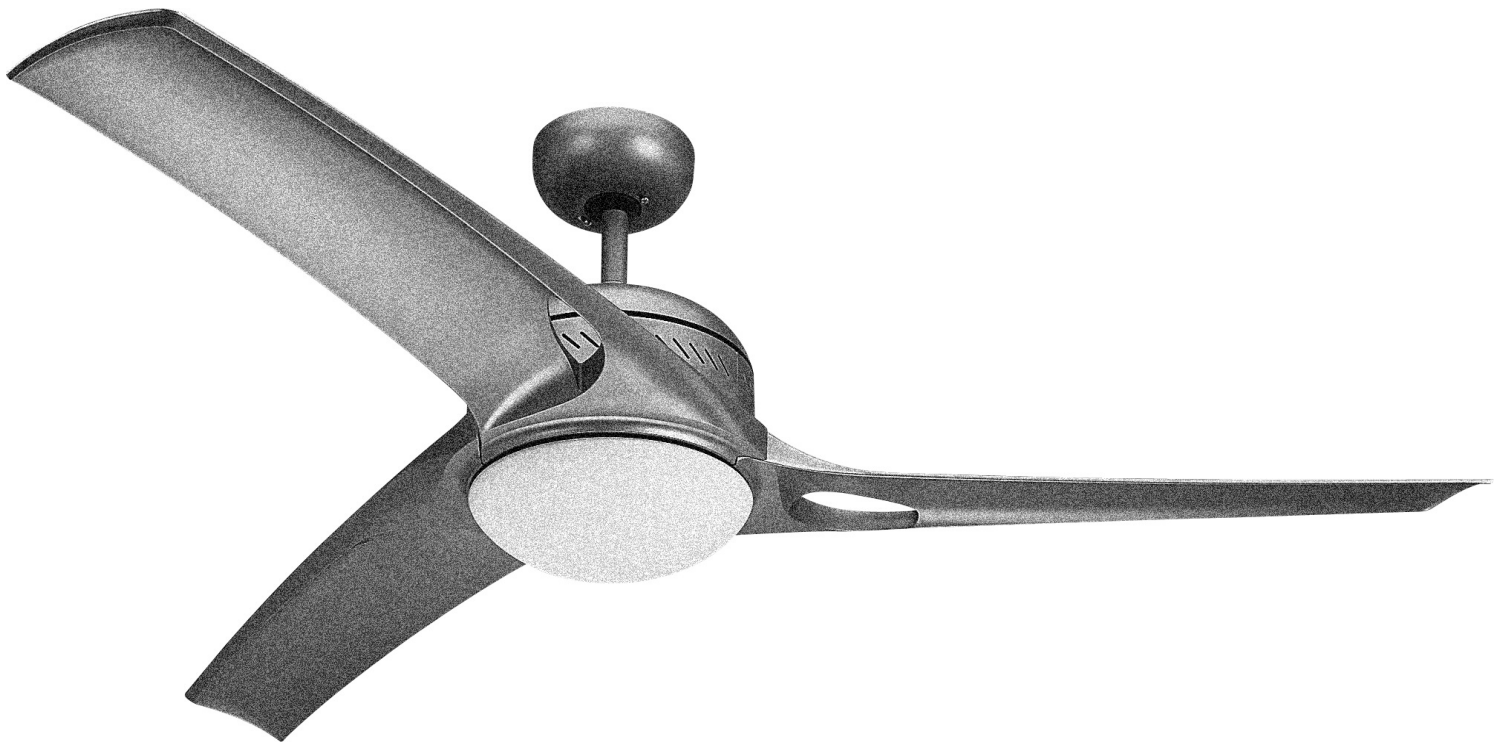

3M052XX0-V1 / 3MTR38XX0-V1 Series Fans

cETL Model Number of 3M052XX0-V1: 3MOR52
cETL Model Number of 3MTR38XX0-V1: 3MTR38

Attach sales receipt to this card and retain as your proof of purchase

DATE OF PURCHASE: _____

RETAILER NAME: _____

MODEL NUMBER: _____

RETAILER ADDRESS: _____

To register your fixture, please visit our website www.montecarlofans.com



3M052XX0-V1: 8.5 kg/18.7 lbs
3MTR38XX0-V1: 7.3 kg/16.1 lbs

Total fan weight with light kit



Cautions and Warnings

WARNING: TO REDUCE THE RISK OF FIRE, ELECTRIC SHOCK, OR INJURY TO PERSONS, OBSERVE THE FOLLOWING READ AND SAVE THESE INSTRUCTIONS

Installation work and electrical wiring must be done by qualified person(s) in accordance with applicable codes and standards (ANSI/NFPA 70-1999), including fire-rated construction.

Use this unit only in the manner intended by the manufacturer. If you have any questions contact the manufacturer.

After making the wire connections, the wires should be spread apart with the grounded conductor and the equipment-grounding conductor on one side of the outlet box and ungrounded conductor on the other side of the outlet box. The splices, after being made, should be turned upward and pushed carefully up into the outlet box.

WARNING: Before you begin installing the fan, servicing or cleaning unit, Switch power off at Service panel and lock service disconnecting means to prevent power from being switched on accidentally. When the service disconnecting means cannot be locked, securely fasten a prominent warning device, such as a tag, to the service panel.

Be cautious! Read all instructions and safety information before installing your new fan. Review the accompanying assembly diagrams.

When cutting or drilling into wall or ceiling, do not damage electrical wiring and other hidden utilities.

Make sure the installation site you choose allows the fan blades to rotate without any obstructions. Allow a minimum clearance of 7 feet from the floor to the trailing edge of the blade.

WARNING: To Reduce The Risk Of Fire, Electric Shock, or Personal Injury, Mount To Outlet Box Marked "Acceptable for Fan Support of 15.9 kg (35 lbs) or less" And Use Mounting Screws Provided With The Outlet Box.

CAUTION: For Compliance with Local Codes and Regulations, If Installing The Secondary Support Safety Cable in the U.S., Do Not Remove Knockouts In The Outlet Box. Mount the secondary support safety cable through the reserved nail/screw hole on the outlet box to the building structure (or the ceiling joist).

WARNING: To reduce the risk of personal injury, do not bend blade holders during installation to motor, balancing or during cleaning. Do not insert foreign object between rotating blades.

Attach the mounting bracket using only the hardware supplied with the outlet box.

WARNING: To reduce the risk of fire or electric shock, this fan must be installed with an isolating wall control/switch.

WARNING: To reduce the risk of fire or electric shock, this fan should only be used with fan speed control part no. UC7067RC manufactured by Rhine Electronic Co., Ltd.

If this unit is to be installed over a tub or shower, it must be marked as appropriate for the application.

Never place a switch where it can be reached from a tub or shower.

The combustion airflow needed for safe operation of fuel-burning equipment may be affected by this unit's operation. Follow the heating equipment manufacturer's guideline safety standards such as those published by the National Fire Protection Association (NFPA), and the American Society for Heating, Refrigeration and Air Conditioning Engineers (ASHRAE) and the local code authorities.

CAUTION: To Reduce the Risk of Electric Shock, Disconnect the electrical supply circuit to the fan before installing the light kit.

All set screws must be checked and tightened where necessary before installation.

Tools Required for Assembly (not included): Electrical Tape, Phillips Screwdriver, Pliers, Safety Glasses, Stepladder and Wire Strippers.

Customer Service
800-969-3347

Customer Service Center
7400 Linder Ave.
Skokie, IL 60077
www.montecarlofans.com

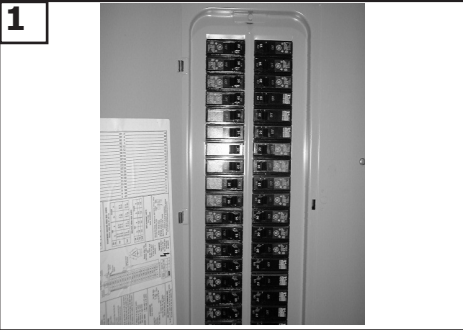

1 Before you begin installing the fan, Switch power off at Service panel and lock service disconnecting means to prevent power from being switched on accidentally. When the service disconnecting means cannot be locked, securely fasten a prominent warning device, such as a tag, to the service panel.

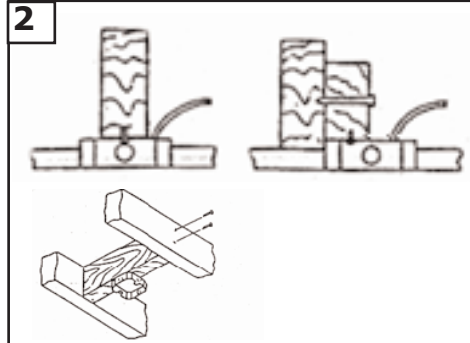

2 Before installing this fan make sure the outlet box is properly installed to the house structure. To reduce the risk of fire, electric shock, or personal injury, mount to outlet box or supporting system acceptable for fan support. (Mounting must support at least 35 lbs.)

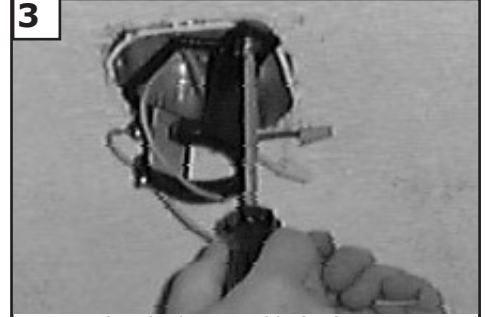

3 Use metal outlet box suitable for fan support (must support 35 lbs). Before attaching fan to outlet box, ensure the outlet box is securely fastened by at least two points to a structural ceiling member (a loose box will cause the fan to wobble). **Use only the screws provided with the outlet box.**

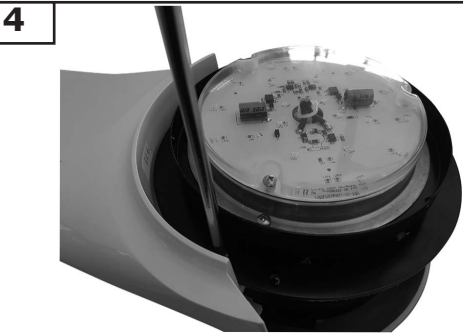

4 Place the fan body with the light fitter pointing upward. Attache the 3 blades as shown above. Tighten set screws securely



5 Carefully turn the motor over so that the upper housing is facing up. Remove the 3 screws holding the upper housing. Save for later use.

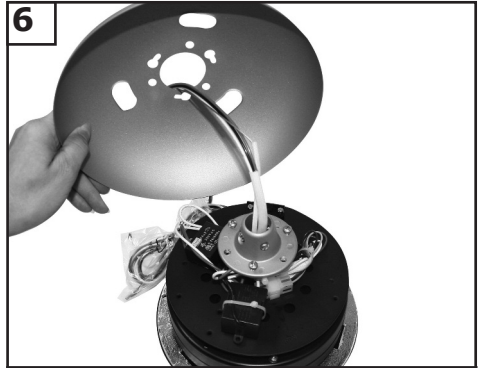

6 Lift off the upper housing to reveal the motor.

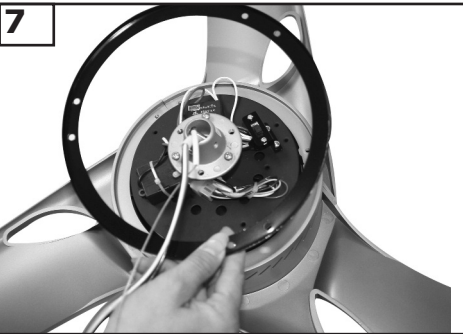

7 Place the blade ring holder over the leadwires and safety cable. Place the blade ring holder onto the blades aligning the screw holes from the blades and ring holder.

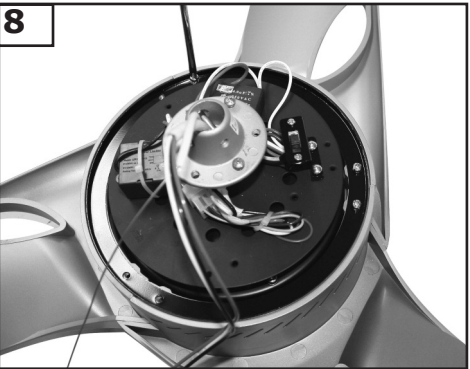

8 Install the motor screws by tightening securely.



9 Place the rubber gasket on the yoke by threading the leadwires and safety cable through the rubber gasket aligning the holes from the gasket and yoke.

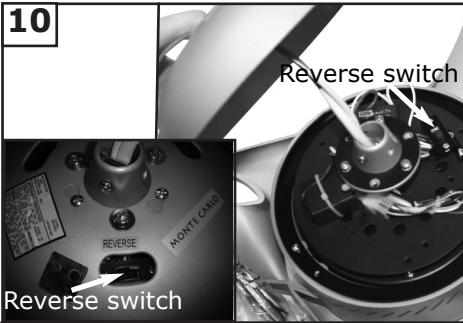

10

Reverse switch

Reverse switch

REVERSE MONTE CARLO

Re-place the upper motor housing onto the fan motor. Be sure the holes are all aligned.
 Note: Align the hole on top housing labeled "REVERSE" with the reverse switch.

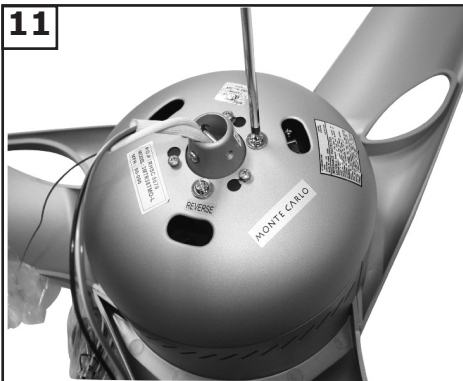

11

Tighten the screws removed from step 5. Tighten securely.

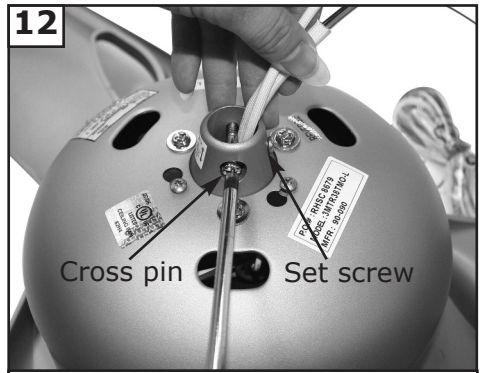

12

Cross pin Set screw

Loosen set screw and then remove cross pin from yoke for downrod to slip into yoke. Keep the cross pin for later use.



13

Place the canopy over the downrod as shown above.



14

Thread the leadwires and safety cable through the downrod.



15

Place the downrod into the yoke aligning the holes on downrod with the holes on the yoke and then re-install the cross pin removed in step 12. Tighten securely.

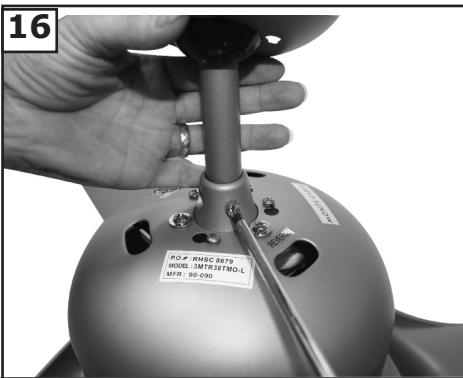

16

Tighten the set screw on the yoke.

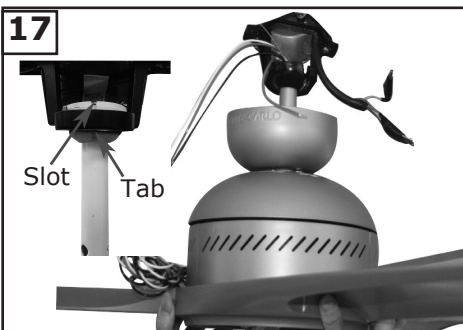

17

Slot Tab

Hang the assembled fan from the mounting bracket. Be sure to turn the fan to lock the slot/tab from the fan and mounting bracket in place.

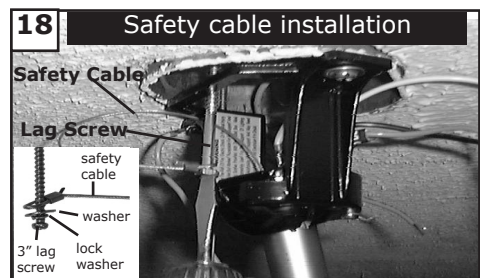

18 Safety cable installation

Safety Cable

Lag Screw

safety cable

washer

3" lag screw lock washer

For Canadian installation and for USA fan and light kit combinations over 35 lbs, in both flush and downrod modes the safety cable must be installed into the house structure beams using 3" lag screws, washers and lock washers provided. Make sure that when the safety cable is fully extended the lead wires are longer than the cable and no stress is placed on the lead wires.
Note: If Installing The Secondary Support Safety Cable in the U.S., Do Not Remove Knockouts In The Outlet Box.

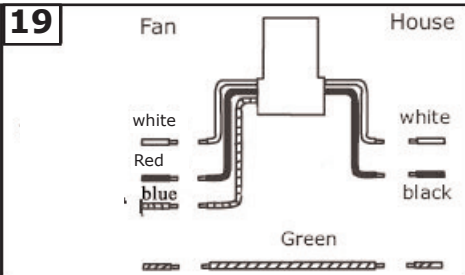

Make wiring connections as indicated above. White from fan to white from remote marked N. Blue from fan to blue from remote marked light. Black from fan to Red from remote marked L. White from house to white from remote marked AC N. Black from house to Black from remote marked AC L. Connect all green ground wires to Ground wire from House.

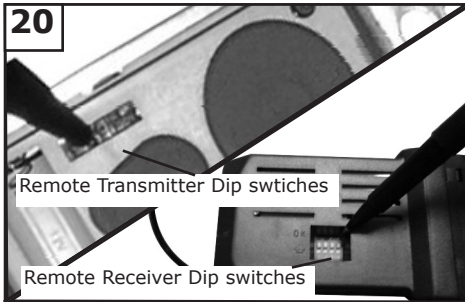

Set dip switches on the Remote Transmitter and Remote Receiver to the same settings. This must be done so the units will communicate properly. If you have other fans you can set to control from one transmitter by setting both receivers the same as the transmitter. If you have more than one fan with remote. You can set the dip switches to different positions to have separate control.

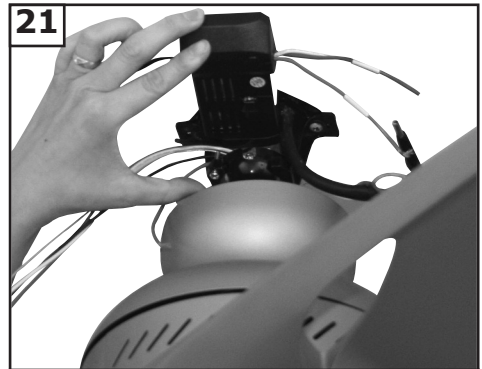

Slide remote receiver into mounting bracket.

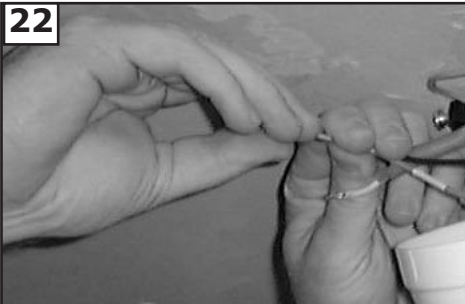

Make wire connections to power source using wire nuts provided. Make sure that no filaments are outside of the wirenut. After making the wire connections, the wires should be spread apart with the grounded conductor and the equipment-grounding conductor on one side of the outlet box and ungrounded conductor on the other side of the outlet box.



Lift the canopy up and twist to lock into place. Tighten the screws securely.

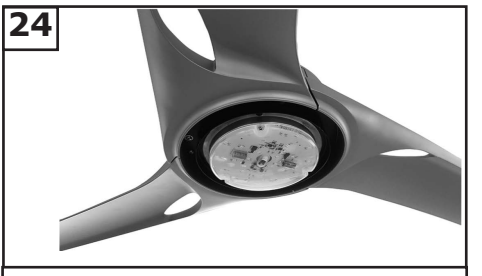

WARNING: Over lamping the fan will result in the fan lights shutting down until the proper wattage of bulbs are installed. Reset the lights by turning off the wall switch, breaker, or by remote. Replace bulbs with the correct wattage bulbs, turn the power on.

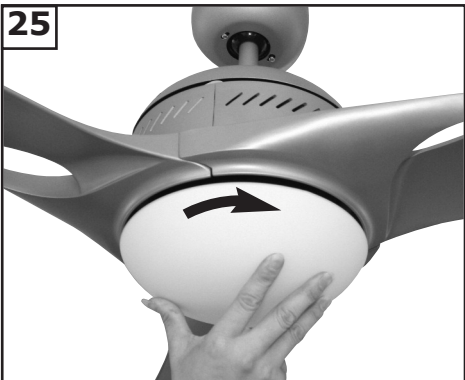

Attach the glass aligning the dimples from the glass and twist to lock into place.

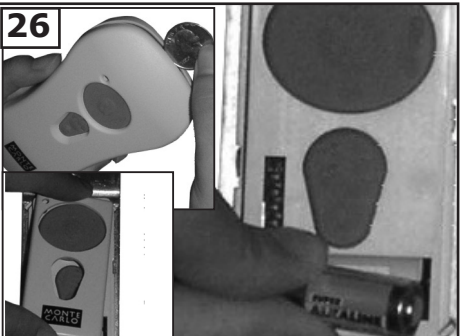

Remove cover by snapping off from top or bottom. Remove battery cover. Install 12V battery into wall remote. Duracell MN21 / Eveready A23 / GP 23A all 12V. Attach cover of remote by placing over buttons and snap the battery cover in place.

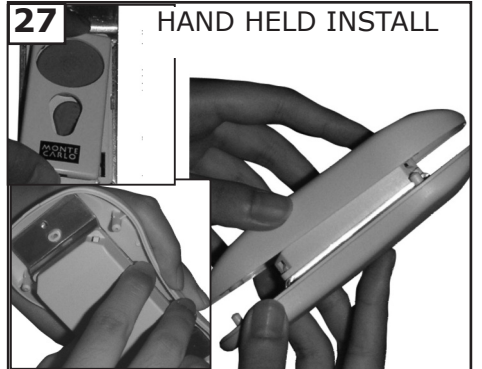

Place face plate over battery compartment and buttons. Place remote over 2 pins on front cover. Attach cover of remote by placing over 4 pins and snapping into place.



28 WALL MOUNT INSTALL

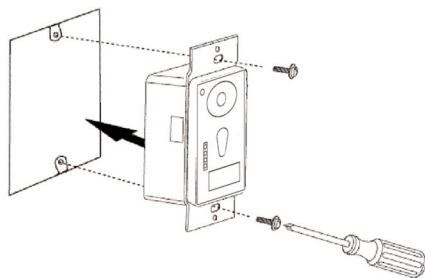

Install wall control unit to outlet box using machine screws provided.

29

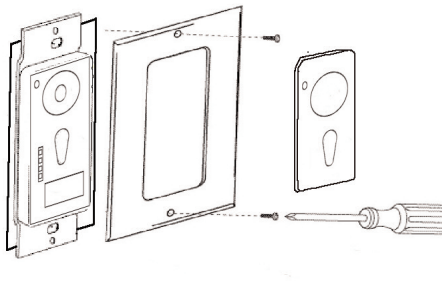

Attach front cover to wall control with screws provided. Snap battery cover in place.

30

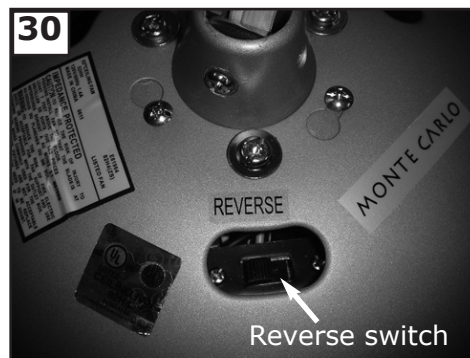

Reverse function for this fan is a switch on top housing of the fan body. Turn fan off and flip switch this will reverse the direction of the blades.

Remote Control Transmitter Features:



FAN SPEED Depress "1 dot" for low speed, "2 dots" for medium or "3 dots" for high. To turn fan off press square".

LIGHT DIMMER To turn light on, press light dimmer once quickly. To turn off press once quickly while light is on. To dim light hold down button "light dimmer". The light will cycle from bright to dim to bright until button is released. Light will maintain last setting if turned off.



TROUBLE SHOOTING

If you have difficulty operating your new ceiling fan, it may be the result of incorrect assembly, installation, or wiring. In some cases, these installation errors may be mistaken for defects. If you experience any faults, please check this Trouble Shooting Chart. If a problem cannot be remedied, or you are experiencing difficulty in installation, please call our Customer Service Center at the

number printed on your parts list insert sheet.

Warning: Before servicing or cleaning unit, Switch power off at Service panel and lock service disconnecting means to prevent power from being switched on accidentally. When the service disconnecting means cannot be locked, securely fasten a prominent warning device, such as a tag, to the service panel.

1. If fan does not start:
 1. Check main and branch circuit fuses or circuit breakers.
 2. Check line wire connections to fan and switch wire connections in switch housing.
 3. Check to make sure the dip switches from transmitter and receiver are set on the same frequency.
 - CAUTION: Make sure main power is turned off.**
 4. Make sure forward/reverse switch is firmly in up or down position. Fan will not operate when switch is in the middle.

2. If fan sounds noisy:
 1. Check to make sure all screws in motor housing are snug (not over tightened).
 2. Check to make sure the screws which attach the fan blade holder to the motor are tight.
 3. Check to make sure wire nut connectors in switch housing are not rattling against each other or against the interior wall of the switch housing.
 - CAUTION: Make sure main power is turned off before entering switch housing.**
 4. Some fan motors are sensitive to signals from Solid State variable speed controls.
 - DO NOT USE a Solid State variable speed control.**
 5. Allow "break-in" period of 24 hours. Most noises associated with a new fan will disappear after this period.

3. If fan wobbles:
 1. Make sure that the ridge of the canopy engages the notch in the downrod ball.
 2. Check that all blades are screwed firmly into blade holders.
 3. Check that all blade holders are tightened securely to motor.
 4. Make sure that canopy and mounting bracket are tightened securely to ceiling junction box and junction box is mounted firmly to ceiling joist.
 5. Most fan wobble problems are caused when blade levels are unequal. Check this level by selecting a point on the ceiling above the tip of one of the blades. Measure this distance from blade tip to ceiling. Keeping measure within 1/8", rotate the fan until the next blade is positioned for measurement. Repeat for each blade. If all blade levels are not equal, you can adjust blade levels by the following procedure. To adjust a blade tip down, insert a washer (not supplied) between the blade and blade holder at the screw closest to the motor. To adjust a blade tip up, insert washer (not supplied) between the blade and blade holder at the two screws farthest from the motor. Reverse the position of the washer if blades mount from top of blade.
 6. If blade wobble is still noticeable, interchanging two adjacent (side by side) blades can redistribute the weight and possibly result in smoother operation.

4. If light does not work:
 1. Check blue wire from fan to make sure it is connected to hot wire from house.
 2. Check for loose or disconnected wires in fan switch housing.
 3. Check for loose or disconnected wires in light kit.
 4. Check for faulty light bulbs.

CAUTION: Make sure main power is turned off before entering switch housing or canopy.

WARNING: Over lamping the fan will result in the fan lights shutting down until the proper wattage of bulbs are installed. Reset the lights by turning off the wall switch, breaker, or by remote. Replace bulbs with the correct wattage bulbs, turn the power on.

Dec.2011 new format

Jan.2011 Update customer service phone number May.2013

Update for CUL regulation

Feb.2018 change to cETL, change listed model number

May.2019 LED