

INSTALLATION INSTRUCTIONS

Item#2841-77-L (New. 11/23/2022)

READ AND SAVE THESE INSTRUCTIONS

WARNING! SHUT POWER OFF AT FUSE OR CIRCUIT BREAKER.
AVERTISSEMENT! COUPER LE COURANT AU NIVEAU DES FUSIBLES OU DU DISJONCTEUR.

MOUNTING THE FIXTURE (Fig. 1)

1. Shut off power at the fuse box or circuit breaker box and remove the old fixture including the mounting hardware.
2. Carefully unpack your new fixture and lay out all the parts in a clear area. Take care not to misplace any small parts necessary for installation.
3. Loosen screws (C) to remove mounting plate (A) from fixture body (D).
4. Attach mounting plate (A) to the junction box (not included) using mounting screws (B) (Size: #8-32N*L0.5"). The side of the mounting plate (A) marked "GND" must face out.

CONNECTING THE WIRES (Fig. 2)

5. Connect the electrical wires as shown in Fig. 2, making sure that all wire connectors are secured. If your junction box has a ground wire (green or bare copper), connect the fixture's ground wire to it. Otherwise, connect the fixture's ground wire directly to the mounting plate (A) using the green screw provided. After the wires are connected, tuck them carefully inside the junction box.

COMPLETING THE INSTALLATION (Fig. 1)

6. Place fixture body (D) over mounting plate (A) and secure with screws (C).
7. Place glass shade (H) over socket cup (I) and sit on metal ring (G). Adjust if needed.

Replacing LED module (Fig. 3)

The LED module can be replaced by a qualified electrician without cutting of wire and without damage to any decorative element to which the fixture is attached. See installation steps for more details (Fig 3.)

- a. Shut off the power.
- b. Remove glass shade (H) from metal ring (G).
- c. Remove screws (C) and fixture body from mounting plate (A). Disconnect wire connectors and place fixture body on a clean surface.
- d. Loosen screws (J) and remove lens (K). Carefully remove LED module (P) from heat sink (M).
- e. Press the button with printed "L" quick connector on LED module (P) with screwdriver (not included) to disconnected the black wire and then disconnect the white wire from the printed "N" quick connector on LED module (P).
- f. Reverse steps b-e for installing the new LED module.

Your installation is now complete. Return power to the junction box and test the fixture.

Note: The illustration in figure 1 on this manual is for installation purposes only. It may or may not be identical to the fixture purchased.

Dimmable with ELV and/or LED compatible wall dimmer switches.

Fig. 1

Set#A-021-110176
-Mounting Screw*2
-Ground Screw
-Mounting Plate

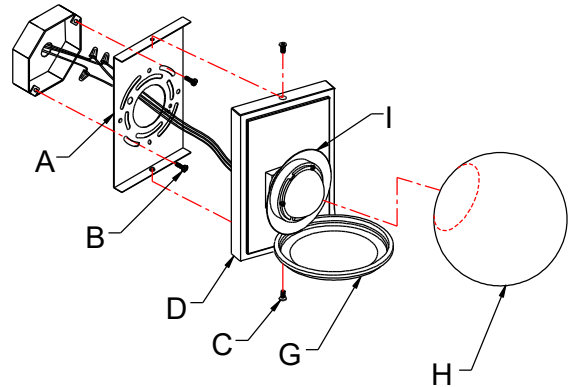

Glass Shade# G2843

Fig. 2

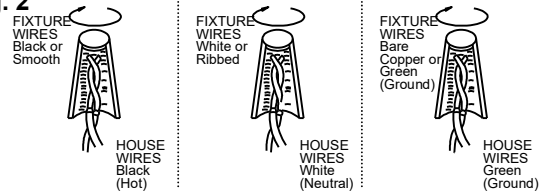
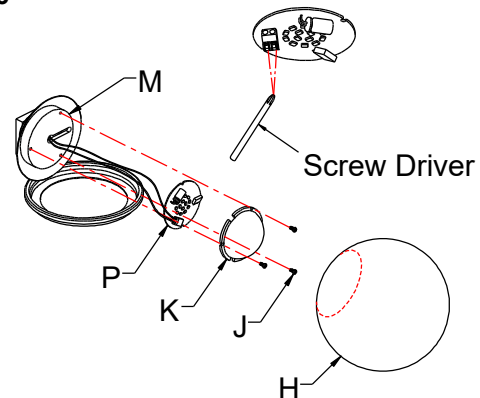

Fig. 3



american
lighting
association