

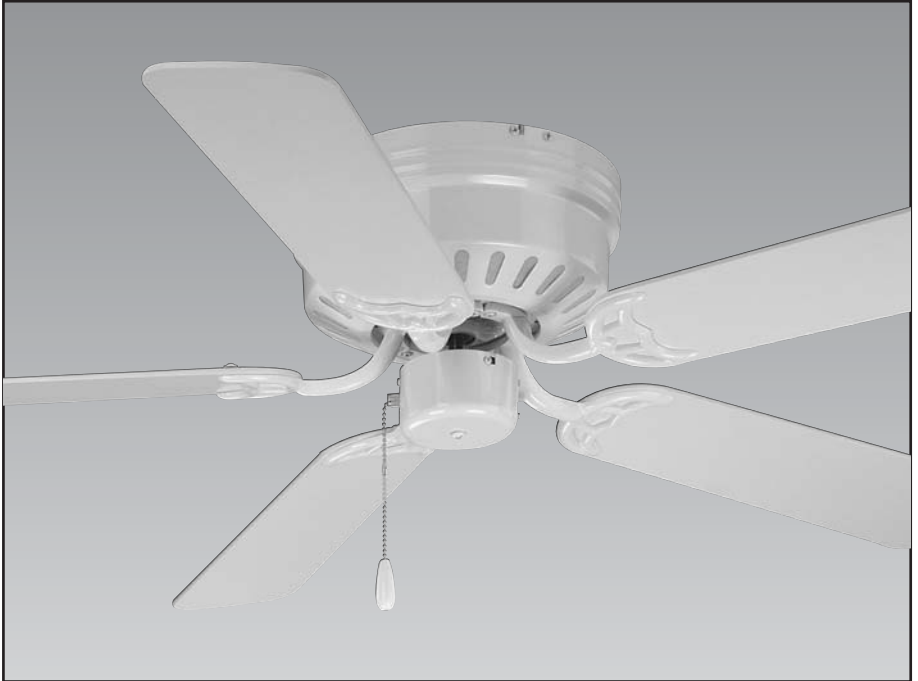

Mesa™
Model No. F566



Instruction Manual

Please Read and Save Instructions





Congratulations on your purchase of a **Minka-Aire™** ceiling fan! Your new fan will be a beautiful addition to your home, and will keep you comfortable throughout the year.

Minka-Aire™ offers a variety of ceiling fans: combinations of wood and brass finishes, solid designer colors, and unique glass and crystal designs. A large selection of light fixtures and light kits are also available. Ask your dealer about accessories that will allow you to customize your fan.

We're certain that your **Minka-Aire™** fan will provide you with many years of comfort, energy savings and satisfaction. To ensure your personal safety and to maximize the performance of your fan, please read this manual thoroughly.

LIMITED LIFETIME WARRANTY

Minka-Aire™ warrants this fan to be free from defects in material and workmanship for one year from the date of purchase, except for the motor. **Minka-Aire™** warrants to the original owner that the motor in this fan shall be free from defects in material and workmanship as long as the original purchaser owns the fan. **Minka-Aire™** only obligation under this limited warranty is to replace, repair or refund the purchase price any fan confirmed by **Minka-Aire™** to be defective in material or workmanship after such fan is returned to **Minka-Aire™** by the original purchaser along with a proof of purchase and with shipping charges prepaid. This warranty shall not apply to fans which have been damaged as a result of improper installation, removed from the original installation or subjected to use for which the fan was not designed. The customer shall be responsible for any cost of removing the old fan, installing a new fan or any other costs. This limited lifetime warranty is in lieu of all other expressed warranties. **Minka-Aire™** shall under no circumstances be liable for any incidental or consequential damages.

Date Purchased _____

Store Purchased _____

Model No. F566

Serial No. _____

SAFETY RULES

1. Before you begin installing the fan, **shut power off** at the circuit breaker of the fuse box.
2. Be cautious! Read all instructions and safety information before installing your new fan. Review accompanying assembly diagrams.
3. Make sure that all electrical connections comply with local codes, ordinances, or National Electrical Codes. Hire a qualified electrician or consult a do-it-yourself wiring handbook if you are unfamiliar with installing electrical wiring.
4. Make sure the installation site you choose allows the fan blades to rotate without any obstructions. Allow a minimum clearance of 7 feet from the floor and 18 inches from the tip of the blades to the wall.
5. If you are mounting the fan to a ceiling fan outlet box, use a U.L. Listed metal octagonal outlet box marked "Acceptable for Fan Support". Secure the box directly to the building structure. The outlet box and its support must be able to support the moving weight of the fan (at least 50 pounds) **Do not use a plastic box.**
6. **Caution:** To reduce the risk of injury use only the screws provided with the outlet box in conjunction with the lock washers provided with the fan.
7. If you are mounting the fan to a joist, make sure it is able to support the moving weight of the fan (at least 50 pounds).
8. After you install the fan, make sure that all mounting components are secured to prevent the fan from falling.
9. Do not insert anything into the fan blades while the fan is operating.
10. Turn the fan off and wait for the blades to stop completely before changing the fan direction.

NOTE: The important safeguards and instructions appearing in this manual are not meant to cover all possible conditions and situations that may occur. It must be understood that common sense, caution and care are factors which can not be built into this product. These factors must be supplied by the person (s) installing, caring for and operating the unit.

WARNING

TO REDUCE THE RISK OF FIRE, ELECTRIC SHOCK OR OTHER PERSONAL INJURY, MOUNT FAN ONLY TO A U.L. LISTED OUTLET BOX OR SUPPORTING SYSTEM MARKED ACCEPTABLE FOR FAN SUPPORT AND USE MOUNTING SCREWS PROVIDED WITH THE OUTLET BOX OR IN CONJUNCTION WITH THE LOCK WASHERS PROVIDED WITH THE FAN. MOST OUTLET BOXES COMMONLY USED FOR FAN SUPPORT OF LIGHTING FIXTURES ARE NOT ACCEPTABLE FOR FAN SUPPORT AND NEED TO BE REPLACED. CONSULT A QUALIFIED ELECTRICIAN IF IN DOUBT.

TO REDUCE THE RISK OF PERSONAL INJURY, DO NOT BEND THE BLADE HOLDERS WHILE INSTALLING, BALANCING THE BLADES OR CLEANING THE FAN. DO NOT INSERT FOREIGN OBJECTS BETWEEN ROTATING FAN BLADES.

TO REDUCE THE RISK OF FIRE OR ELECTRIC SHOCK, DO NOT USE THIS WITH ANY SOLID-STATE SPEED CONTROL DEVICE.

INSTALLING THE FAN

Tools Required: Phillips screw driver; slotted screw driver; step-ladder; wire cutters; electrical tape.

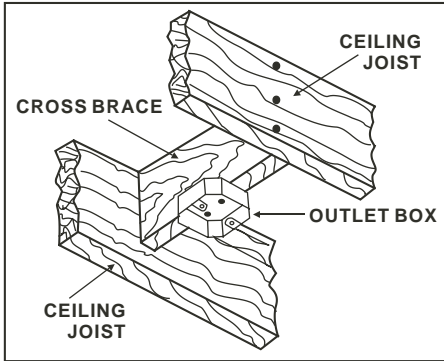

FIG. 1

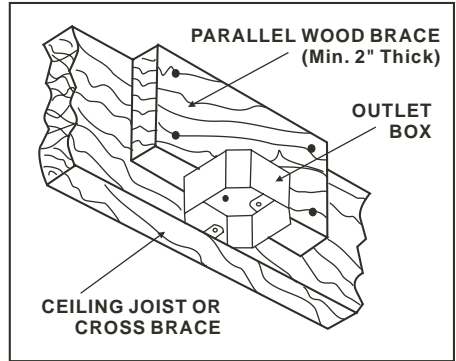

FIG. 2

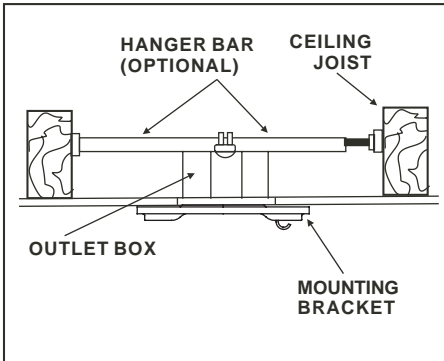

FIG. 3

MOUNTING OPTIONS

If there isn't an existing mounting box, then read the following instructions.

Disconnect the power by removing fuses or turning off circuit breakers.

Secure the outlet box directly to the building structure. Use appropriate fasteners and building materials. The outlet box and its support must be able to fully support the moving weight of the fan (at least 50 lbs.). **Use a UL Listed metal outlet box. Do not use a plastic outlet box.**

Figure 1, 2 and 3 are examples of different ways to mount the outlet box.

To hang your fan where there is an existing fixture but no ceiling joist, you may need to install a hanger bar as shown in Fig. 4 (available at your **Minka-Aire™** dealer).

FLUSH MOUNT CEILING FAN INSTALLATION

1. **DISCONNECT ELECTRICITY** to the existing fixture occupying the space where you would like to install the fan. After removing the old fixture, check the mounting and stability of the ceiling outlet box. If the outlet box is secure, then proceed with the installation procedure. If not, reinforce the outlet box for strength and safety, and then proceed.

2. **ATTACH THE MOUNTING BRACKET** to the outlet box with two screws and washers provided, making sure the bracket is tight and secure.

3. **LIFT FAN INTO POSITION** by hanging the motor assembly onto the hook of the ceiling mounting bracket allowing it to hang freely.

4. **MAKE THE ELECTRICAL CONNECTIONS** by connecting the black and blue wire from the fan to the black wire in the outlet box. Then, connect the white wire from the fan to the white wire from the outlet box. Last, connect the green wire from the fan to the green or ground wire from outlet box.

NOTE: This procedure is for hanging the fan only. For fans equipped with wall controls or lights kits, please refer to insert "A"

5. **MOVE FAN INTO POSITION** over the four mounting studs and secure with the provided washers and nuts

6. **INSTALL THE DECORATIVE HOUSING** over the motor assembly and secure with the four mounting screws.

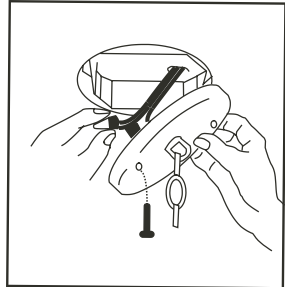

1

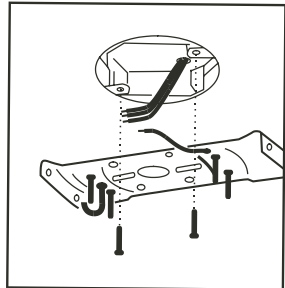

2

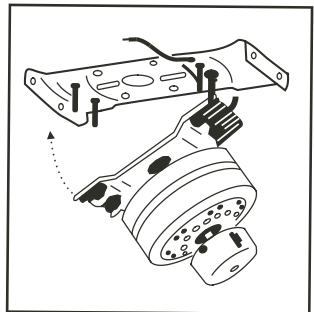

3

4 (See Insert "A")

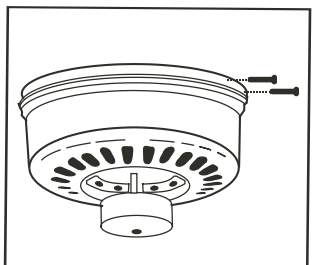

6

INSERT "A" WIRING DIAGRAMS

FAN CONTROLLED BY PULL CHAIN, LIGHT KIT CONTROLLED BY PULL CHAIN.

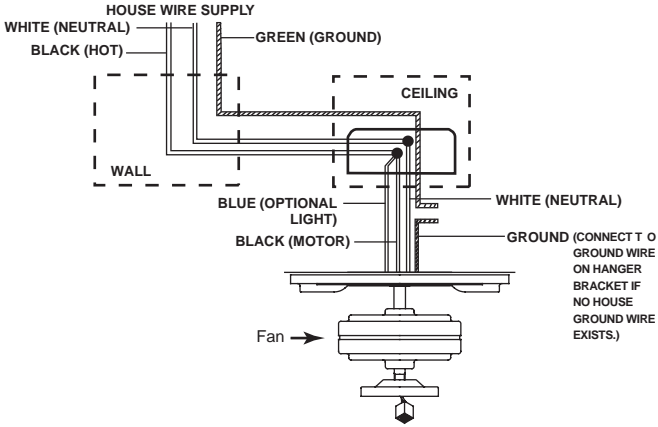

FAN CONTROLLED BY PULL CHAIN, LIGHT KIT CONTROLLED BY WALL SWITCH.

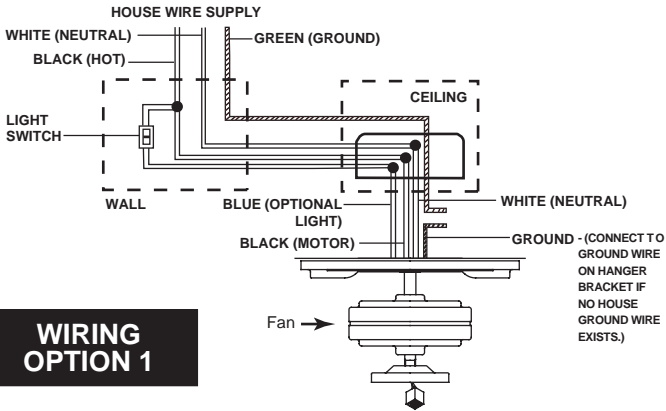

WIRING OPTION 1

FAN CONTROLLED BY WALL CONTROL, LIGHT KIT CONTROLLED BY LIGHT SWITCH.

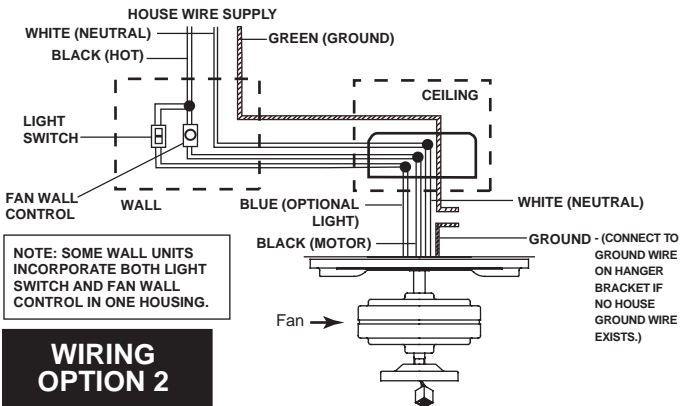

NOTE: SOME WALL UNITS INCORPORATE BOTH LIGHT SWITCH AND FAN WALL CONTROL IN ONE HOUSING.

WIRING OPTION 2

FLUSH MOUNT FAN BLADE INSTALLATION

Each set of blade holder has gone through stringent factory testing and is weighed and matched to within one gram. In addition to size and weight, grain color, and texture, and lacquer consistency have also been checked to insure long life in both performance and beauty.

1. LAYOUT THE BLADES AND BLADE IRONS, and locate the proper screws for attaching the blades to the blade irons.

2. ATTACH BLADE IRONS TO THE BLADES by using screw (A) through the top of the blade and into the blade iron. Thread screw (B) through the bottom of the blade iron.

3. ATTACH THE BLADE ASSEMBLY TO THE FAN by tightening screw (B) to the fan motor.

4. ATTACH THE SWITCH CUP if not already attached by connecting the electrical connectors, sliding the cup into place and securing it with the provided screws.

YOUR INSTALLATION IS COMPLETE.

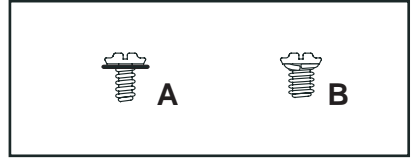

1

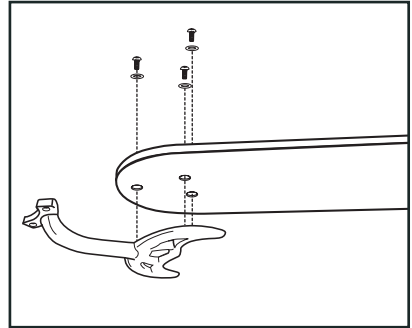

2

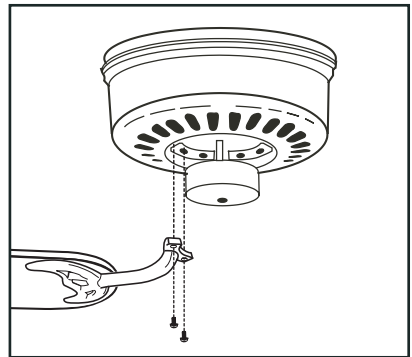

3

ATTACHING THE SWITCH CUP

Step 1. Remove the screws from the switch cup plate. While holding the switch cup, firmly snap the wire moxelles together. Next, slide switch cup up against plate and rotate it until the screw holes are aligned. Secure switch cup to plate using the screws removed earlier. (Fig. 1)

NOTE: DO NOT PINCH WIRES BETWEEN THE SWITCH HOUSING AND THE SWITCH CUP PLATE.

Step 2. Attach the pull chain fob to the chain on the switch cup. (Fig. 1)

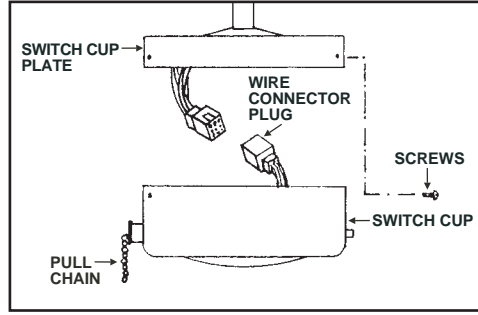

1

CONNECTING A LIGHT FIXTURE

REMEMBER to disconnect the power. The fan blades must already be attached to the fan. The following instructions should help you install most light kits. Also refer to the instructions included with purchased kits.

Step 1. Remove existing switch cup from bottom of fan. (Fig.18)

Step 2. Remove plug screw in bottom of switch cup. (Fig.18)

Step 3. Feed black and white wires from light kit through hole in bottom of switch cup and thread stem of light kit into same hole until snug. (Fig.18)

Step 4. Locate the Blue and White wires inside the switch cup marked "for light" and remove the plastic wire nuts. Connect the blue wire to the black wire from the light kit using the plastic wire nuts. Next connect the white wires together. (Fig.19)

Step 5. Tuck all wires into the switch cup and reinstall the switch cup onto the fan. (Fig.19)

Step 6. Attach the pull chain fob to the light kit.

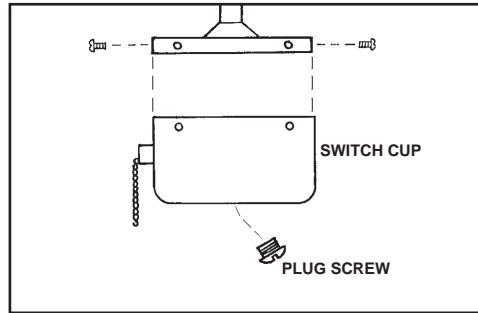

2

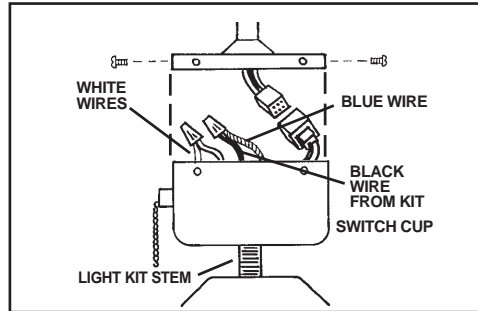

3

OPERATING YOUR FAN

Restore power to ceiling fan and test for proper operation.

Speed settings for warm or cool weather depend on factors such as the room size. Ceiling height, number of fans, etc.

The Reverse switch is located on the switch cup. Slide the switch to the Left for warm weather operation. Slide the switch to the Right for cool weather operation.

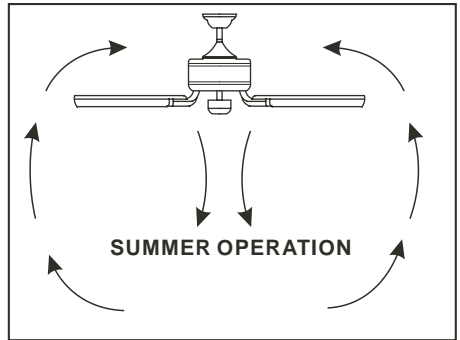

NOTE: Wait for fan to stop before changing the setting of the slide switch.

Warm weather - (Forward)

A downward airflow creates a cooling effect as shown in Fig. 1. This allows you to set your air conditioner on a warmer setting without affecting your comfort.

Cool weather - (Reverse)

An upward airflow moves warm air off the ceiling area as shown in Fig. 2. This allows you to set your heating unit on a cooler setting without affecting your comfort.

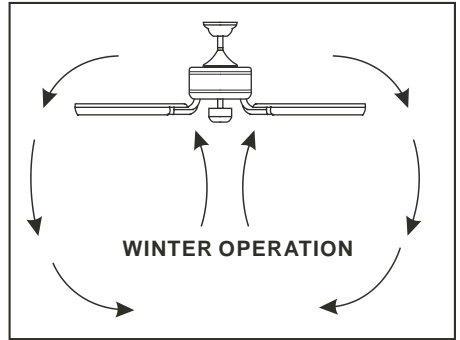

The pull chain controls the fan speed as follows:

1st pull	- High
2nd pull	- Med.
3rd pull	- Low
4th pull	- Off

CARE OF YOUR FAN

Here are some suggestions to help maintain your fan.

1. Because of the fan's natural movement some connections may become loose. Check the support connections, brackets and blade attachments twice a year. Make sure they are secure. (It is not necessary to remove fan from the ceiling).

2. Clean your fan periodically to help maintain its new appearance over the years. Use only a soft brush or lint free cloth to avoid scratching the finish. Plated finishes are sealed with lacquer to minimize discoloration or tarnishing. Do not use water when cleaning, this could damage the motor, wood blades or possibly cause an electrical shock.

3. If your fan is provided with wood veneer blades; you can apply a light coat of furniture polish for additional protection and enhanced beauty. Cover small scratches with a light application of shoe polish.

4. Use a lint free lightly damp cloth or duster to remove dust from the blades.

5. There is no need to oil your fan. The motor has permanently lubricated bearings.

6. If your fan is provided with glass shades, clean with lukewarm soapy water and a soft cloth or sponge. **DO NOT IMMERSE GLASS SHADES IN HOT WATER. DO NOT PUT GLASS SHADES INTO AN AUTOMATIC DISHWASHER.**

WARNING!

Make sure the power is off at the electrical panel box before you attempt any repairs. Refer to the section, "Electrical Connections".

TROUBLESHOOTING

Symptoms

Solution

Fan Will not Start

- Check to make sure the wall switch is turned on.
- Check circuit fuses or breakers.
Caution! Make sure the power is turned off before performing the following steps;
- Remove canopy and check wire connections.
- If using a remote controlled fan; check to see that the deep switches from transmitter and receiver are set to the same frequency code.
- Check wall control transmitter connections (if applicable).

Fans/Light Turn On and Off Unexpectedly

- This is caused by interference, change the code frequency from the transmitter and receiver. Any code combination will operate the fan or light (remote controlled fans only).

Fan Sounds Noisy

- Allow a 24-hour "break in" period. Most noises associated with a new fan will go away during this time.
- Make sure all blade attachment screws are tight.
- Make sure outlet box is secured to building structure, if necessary use the wood screws provided to further secure outlet box to joist.
- Make sure hanger bracket is secure to the outlet box, screws are tight.

Fan Wobble

- **NOTE:** All blade sets are grouped by weight. Because wood and plastic blades vary in density, the fan may wobble even though blades are matched.
- Make sure all blade attachment screws are tight.
- Make sure outlet box is secured to building structure, if necessary use the wood screws provided to further secure outlet box to joist.
- Make sure hanger bracket is secure to the outlet box, screws are tight.
- Use the balancing kit provided if the wobble is excessive (follow instructions included with balancing kit)

SPECIFICATIONS

Fan Size	Speed	Volts	Amps	Watts	RPM	CFM	N.W.	G.W.	C.F.
42"	Low	120	0.19	10	120	800	5.17 kgs	6,17 kgs	0,74'
	Medium	120	0.30	25	161	2400			
	High	120	0.38	45	220	4700			

These are typical readings. Your actual fan may vary. They do not included amps or wattage used by the light kit.

For any additional information about your Minka Aire® Ceiling fan, please write to;



1151 W. Bradford Court, Corona, CA 92882

For Customer Assistance Call: 1-800-307-3267