

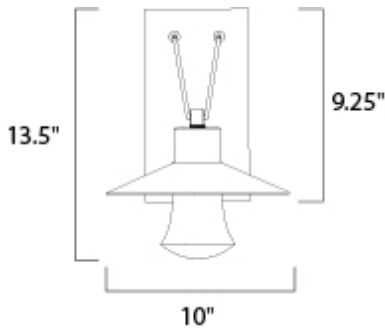

**PRODUCT DESCRIPTION**

Conical shades finished in Architectural Bronze appear to be suspended by its stainless steel cable. Concealed inside these shades is a high powered COB LED which shines into a heavy Clear glass font. The bottom of these fonts have an additional thickness of glass for better light distribution and lighting effect.



**MEASUREMENTS**

DIMENSION : 10" W x 13.5" H x 11.5" Ext  
 BACK PLATE : 4.5" W x 9.25" H x 7.25" HCO  
 HANGING WEIGHT : 4.4 lb

**LAMPING**

INPUT VOLTAGE : 120V  
 LUMENS : 770 Rated (590 Del.)  
 BULB : 1 x 11W LED PCB Integrated , 11W Total  
 BULB INCLUDED : (Integrated)  
 DIMMABLE : No  
 CRI : 90+ CRI  
 COLOR\_TEMP : 3000K

**FINISHES OPTION**

- Architectural Bronze
- Brushed Aluminum

**GLASS**

Clear CL

**MATERIAL**

Die Cast Aluminum, Glass

**RATINGS**

cETLus  
 Wet Location  
 For Outdoor



**ADDITIONAL**

RATED LIFE 40000 Hours  
 OPERATING TEMPERATURE:  
 -20°C (-4°F), 40°C (104°F)

Always consult a qualified electrician before installing any lighting product.



**WESTERN DISTRIBUTION CENTER (HEADQUARTER)**  
 253 NORTH VINELAND AVE | CITY OF INDUSTRY, CA 91746

**EASTERN DISTRIBUTION CENTER**  
 4200 SHIRLEY DR. | ATLANTA, GA 30336

P. 626.956.4200 | F. 626.956.4225 | maximlighting.com