

INSTALLATION INSTRUCTION/MANUAL

DE INSTRUCCIONES

ALASKA 9/ALASKA 10

5367-848RPP-BK-3000-TR/5367-860RPP-BK-3000-TR

LED PENDANT



WARNING

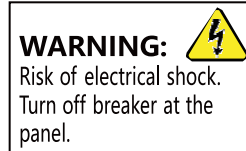

IMPORTANT: NEVER attempt any work without shutting off the electricity.

Read all instructions before installing.

System is intended for installation by a qualified electrician in accordance with the National Electrical Code and local regulations.

Go to the main fuse box, or circuit breaker. Place the main power switch in the "OFF" position and unscrew the fuse(s) or switch "OFF" the circuit breaker switch(es) that control the power to the fixture or room that you are working on.

Place the wall switch in the "OFF" position.

CAUTION

All parts must be used as indicated in these instructions. Do not substitute any parts, leave parts out, or use any parts that are worn out or broken. Failure to follow this instruction could invalidate the ETL/CETL listing of this fixture.

CAUTION When handling the fixture, do not apply pressure to the LEDs. Hold the fixture by the base only.

ADVERTENCIA

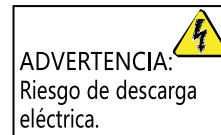

IMPORTANTE: NUNCA intente hacer trabajos sin desconectar el suministro eléctrico.

Lea y comprenda todas las instrucciones e ilustraciones por completo antes de proceder con el ensamblaje e instalación de esta lámpara.

Sistema está diseñado para ser instalado por un electricista calificado, de acuerdo con el código eléctrico nacional y las normas locales.

Diríjase a la caja de fusibles o a la caja del interruptor de circuito principal en su hogar. Coloque el interruptor de alimentación principal en la posición "OFF" (APAGADO).

Coloque el interruptor de la pared en la posición "OFF" (APAGADO).

PRECAUCIÓN

Todas las piezas deben usarse como lo indican estas instrucciones. No reemplace las piezas, no omita piezas durante la instalación ni utilice piezas gastadas o rotas. El incumplimiento de esta indicación podría invalidar la calificación.

ETL/CETL esta lámpara. PRECAUCIÓN Al manipular el aparato, no aplique presión a los LED, mantenga el aparato en la base sólo.

HARDWARE

A1

Wire Connector



Qty: 3 pcs + 1 extra
7EAC112201

B1



Junction Box Screw
Qty: 2 pcs + 1 extra
7MPF0415C2
#5/32x30

C1



Plastic Anchor Qty:
4pcs + 1 extra
7TDD082401

D1



Wood Screw
Qty: 4pcs + 1 extra
7MPF2204J2
Φ4x40
Nickel plating

F1



Mounting Screw
Qty: 1 extra
7MPF0409S3
M4x10
Nickel plating



INSTALLATION INSTRUCTION

ALASKA 9/ALASKA 10

5367-848RPP-BK-3000-TR/5367-860RPP-BK-3000-TR

LED PENDANT

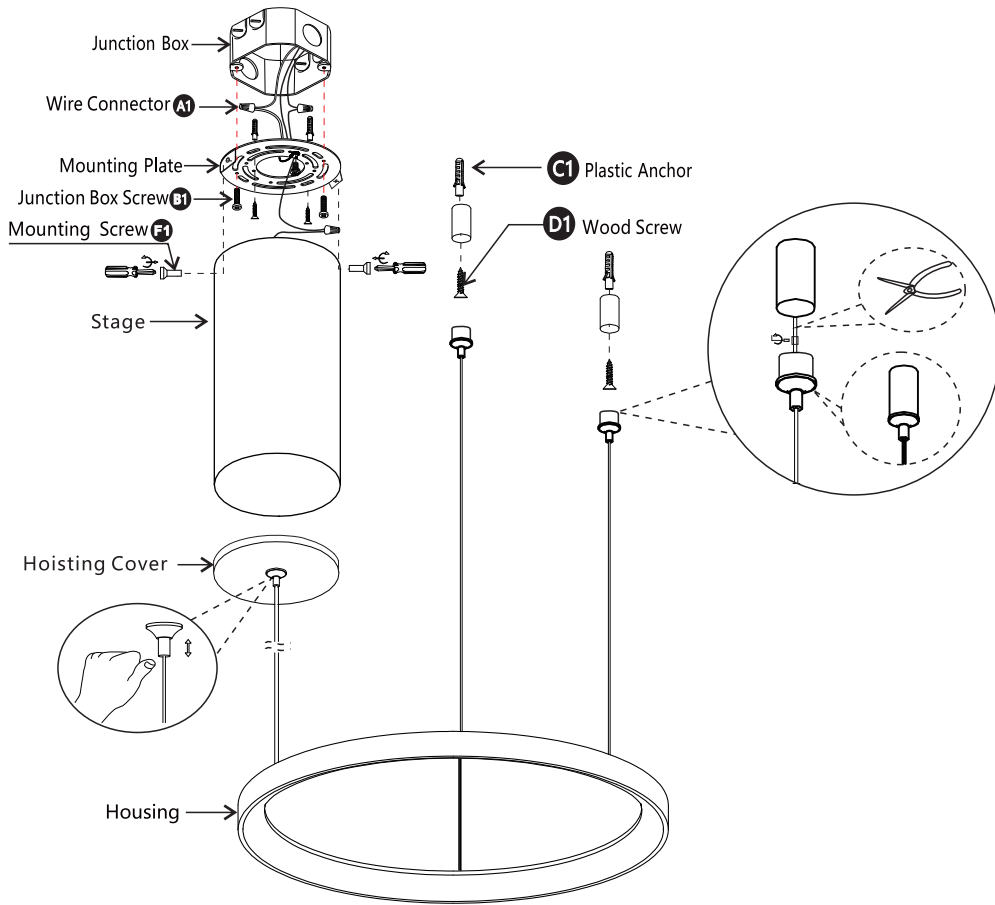

Back Plate Dimensions

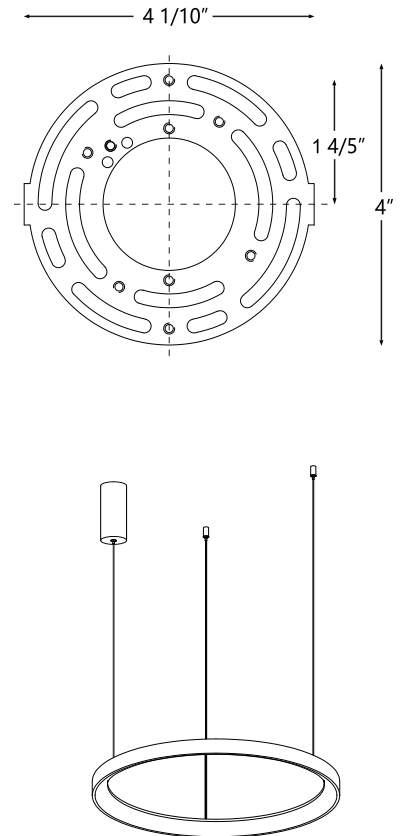

PREPARATION

1. Shut off the power at the circuit breaker and remove existing fixture, including the crossbar.
2. Carefully unpack your new fixture and lay out all the parts on a clear area. Be careful not to lose any small parts necessary for installation.



CONNECTING THE WIRES (Fig. 2)

3. Remove the mounting screw (F1) from the fixture, take down the lamp shade.
4. Remove the nuts (E1) from the PCB board; take out the mounting plate.
5. Drill holes in the wall aligned with the key holes in the fixture base, insert the plastic anchor (C1).
6. Secure the mounting back plate to the junction box using junction box screws (B1). The side of the mounting back plate marked "GND" must face out.
7. Connect the Driver's input wires to junction box wires as shown in Fig. 2, making sure that all wire connectors (A1) are secured. If your outlet box has a green or bare copper ground wire, connect the fixture's ground wire to it. Otherwise, connect the fixture's ground wire directly to the back plate using the green screw provided. After wires are connected, tuck them carefully inside the junction box.

MOUNTING THE FIXTURE (Fig. 1)

8. Secure the fixture base to the mounting plate using nuts (E1), fasten it to the wall using wood screw (D1).
9. Secure the lamp shade onto the fixture base with mounting screw (F1).

Fig. 2 Wiring

	Fixture Wires Black or Smooth	House Wires Black (Hot)
	Fixture Wires White or Ribbed	House Wires White (Neutral)
	Fixture Wires Bare wire (Ground)	House Wires Green or Bare Copper (Ground)