

# MESH

design Francisco Gomez Paz

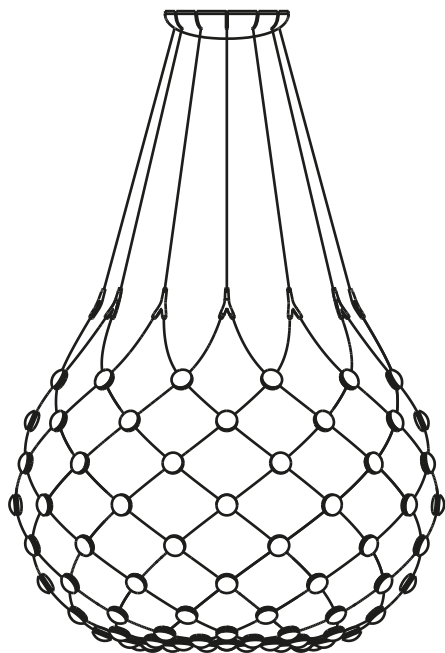

**LUCE  
PLAN**

D86/T1..T5/1..8  
D86N - D86NPI



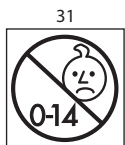
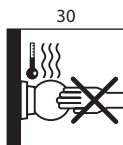
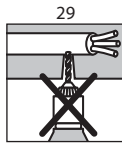
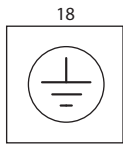
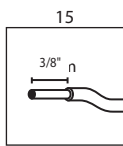
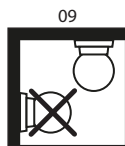
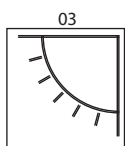
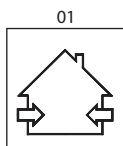

D86/T1/1

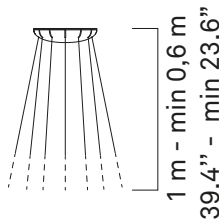

kg 1,5kg lb 3,3 lb

D86/T5/1

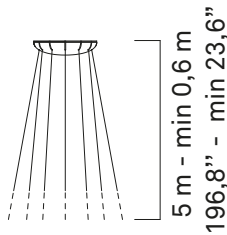

kg 1,7kg lb 3,75 lb



D86N

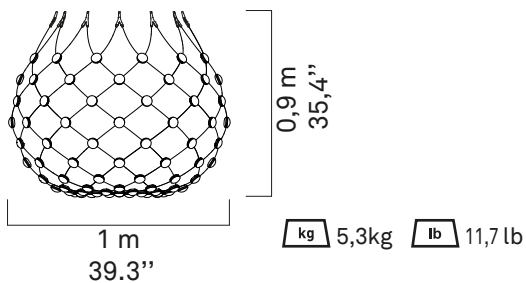

D86/T1/8

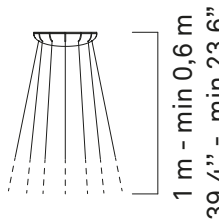

kg 1,2kg lb 2,65 lb

D86/T5/8

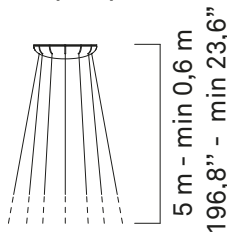

kg 1,4kg lb 3,1 lb



D86NPI

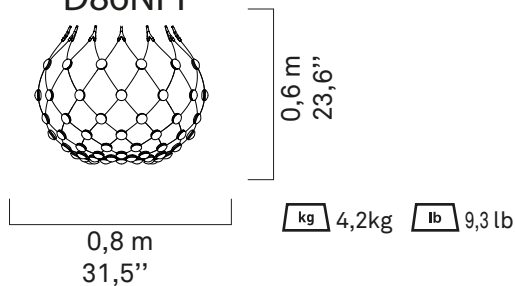

D86/T1/1

D86/T5/1

D86/T1/8

D86/T5/8

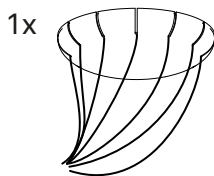

---

D86/N

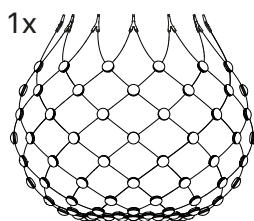

---

D86/NPI

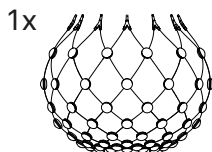

# 1

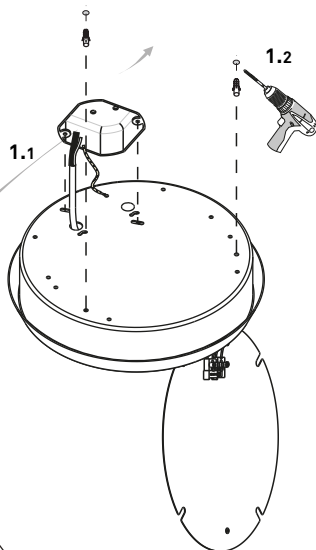
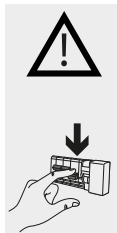

⏏ yellow/green  
jaune/vert  
amarillo/verde

N white  
blanc  
blanco

L black  
noir  
negro

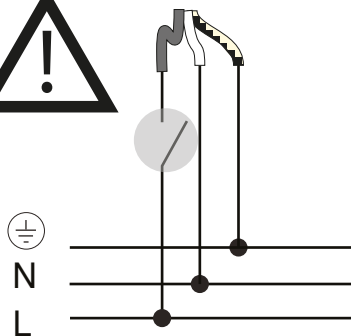
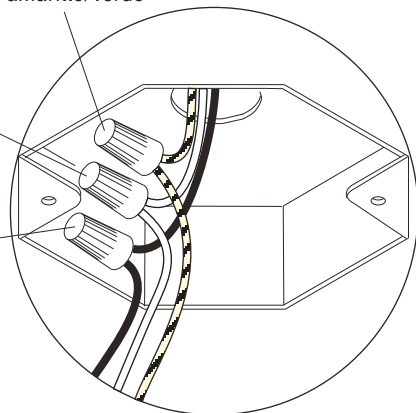

22  
(0,1%) MAX (100%)

2

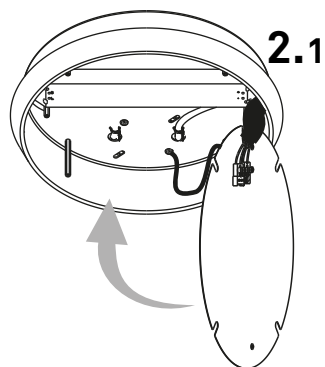

2.2



Click!

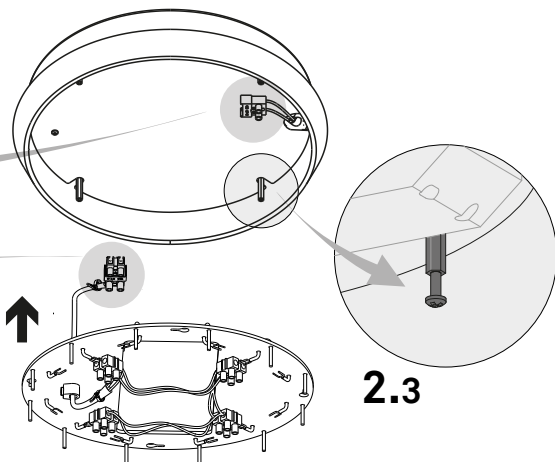

2.3

2.4

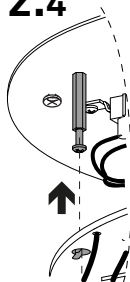

2.5

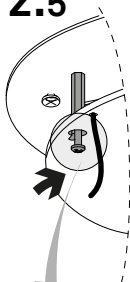

2.6

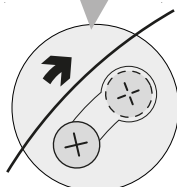

# 3

D86/T1/1 | D86N  
D86/T5/1 |  
D86/T1/8 | D86NPI  
D86/T5/8 |

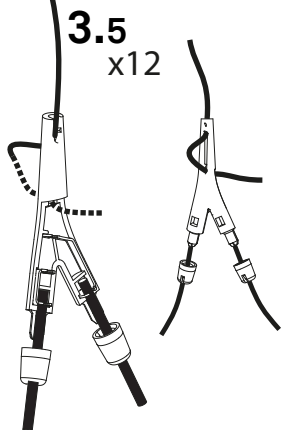
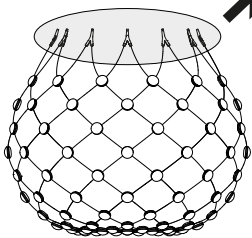
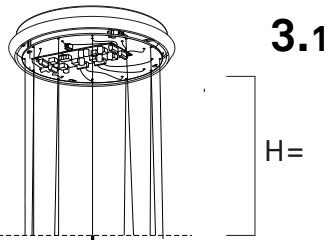

3.2

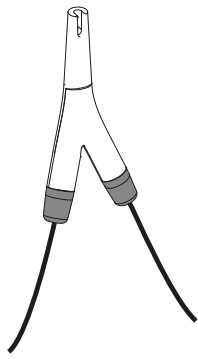

3.3  
x12

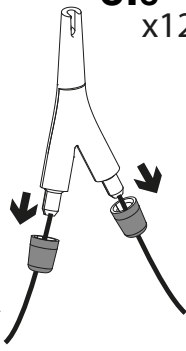

3.4  
x12

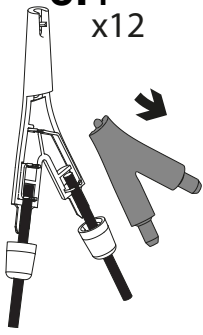

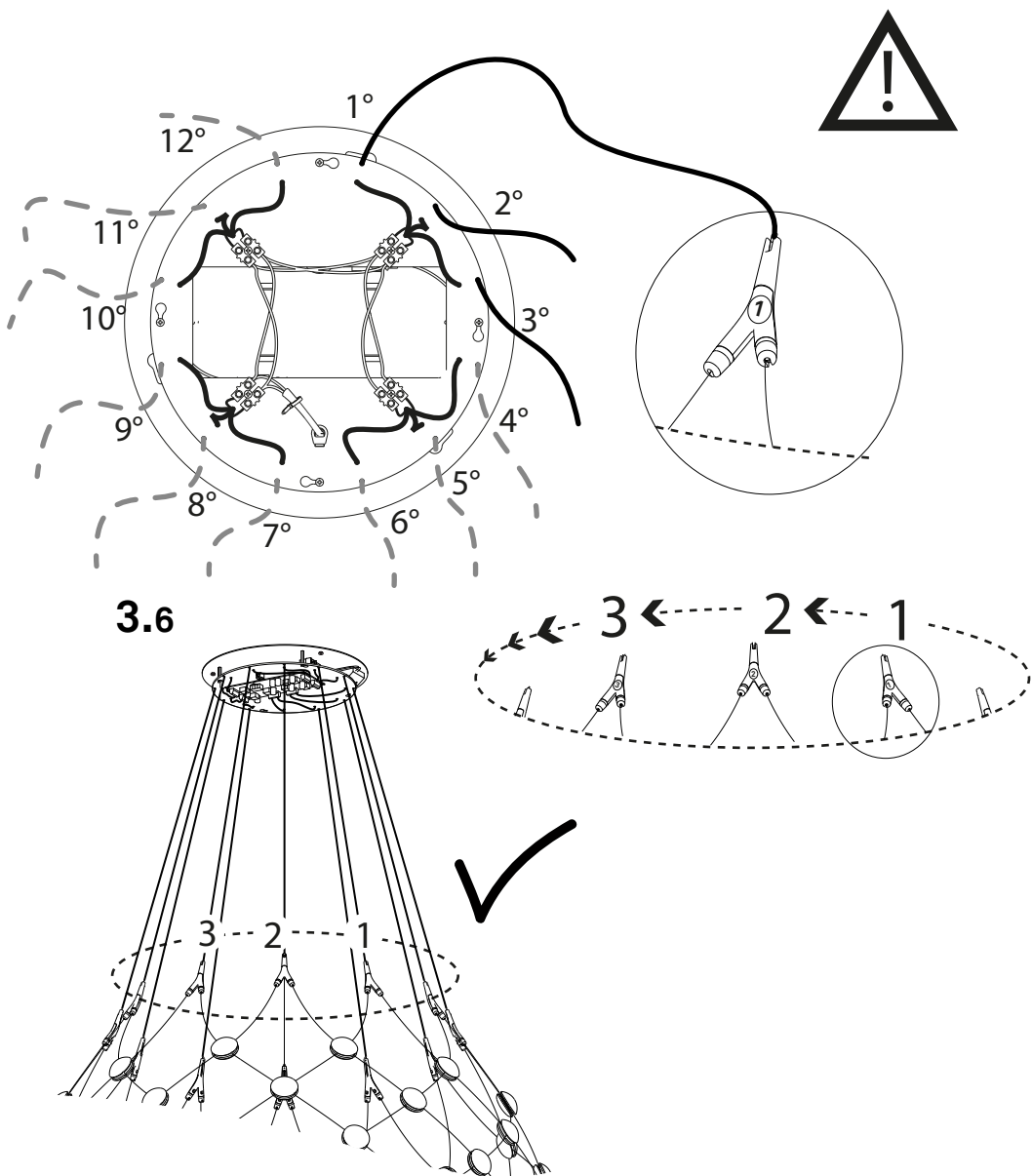



# 4

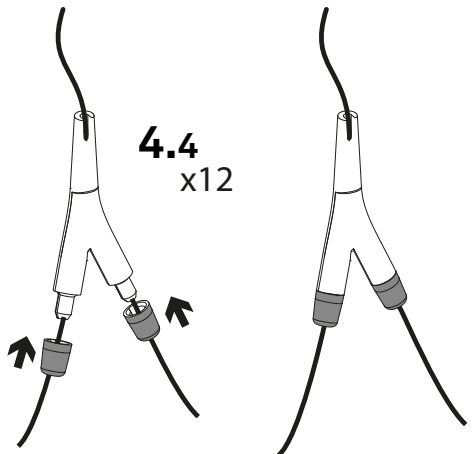
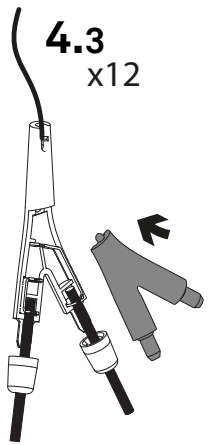
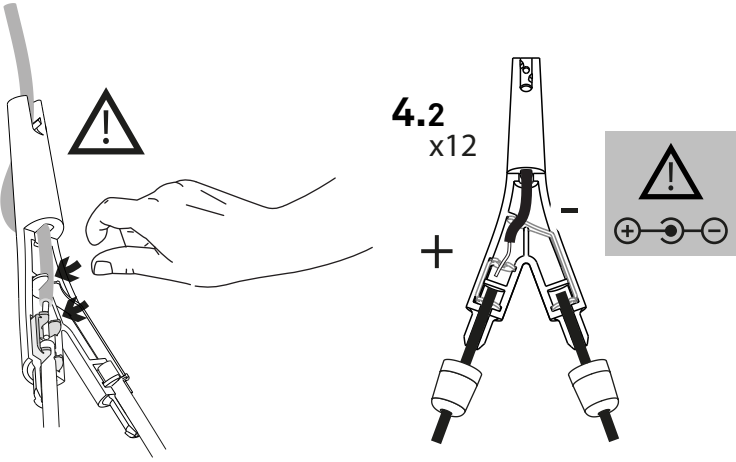
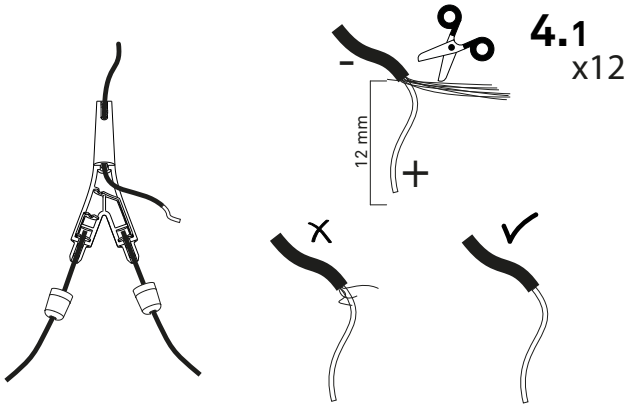

5

D86/T1/1 | D86N  
D86/T5/1 |  
D86/T1/8 | D86NPI  
D86/T5/8 |

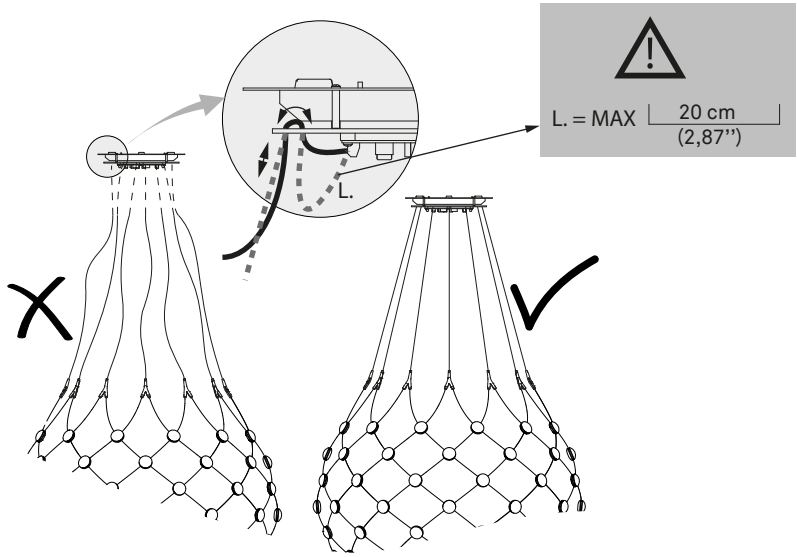
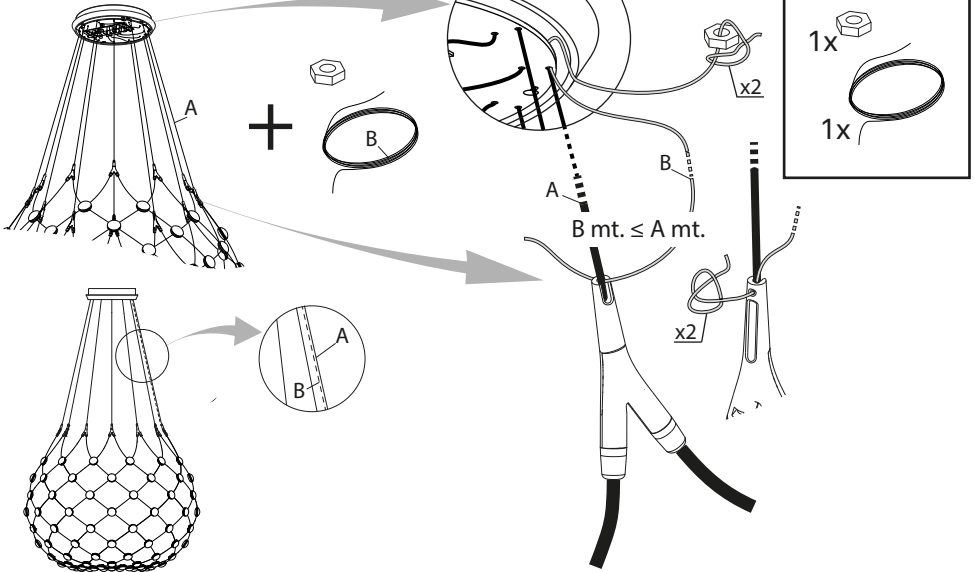

6

D86/T1/1 | D86N  
D86/T5/1 |  
D86/T1/8 | D86NPI  
D86/T5/8 |

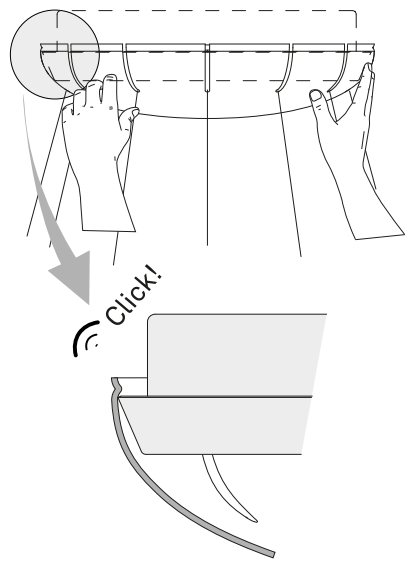
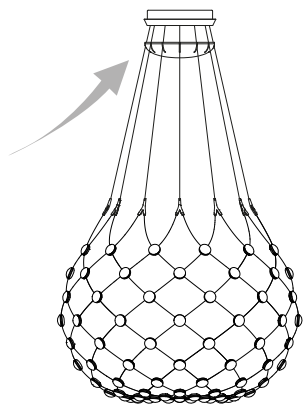
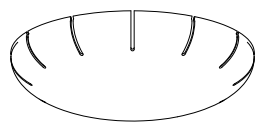

1.

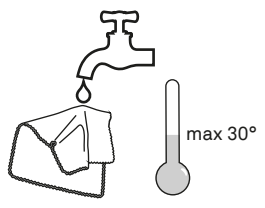

2.



3.

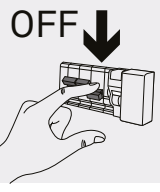
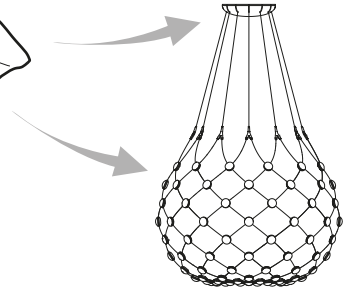
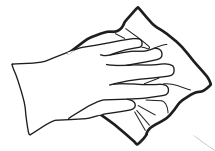



[www.luceplan.com](http://www.luceplan.com)

D860I0102