

# HOPE

design Francisco Gomez Paz / Paolo Rizzatto

**LUCE  
PLAN**

Type: Suspension

Light source: D66/12 - D66/18 150W A-21, 150W T-10, 15W E26 SBLED  
 D66/42 3 x 150W A-21, 3X150W T-10, 3X15W E26 SBLED  
 D66/105 5 x 150W A-21, 5X150W T-10, 5X15W E26 SBLED

Product use: Indoor

Materials: Structure in polished stainless steel and polycarbonate arms, methacrylate prismatic lenses

Colors: Transparent

Description: Incredibly light and easy to dismantle, Hope presents the magic of traditional chandeliers, reinterpreting them with sophisticated modern technologies and contemporary materials. A series of thin methacrylate Fresnel lenses multiply the light from the light source, recreating a pleasant, glittery and party-like atmosphere, sprinkled with thousands of tiny reflections.

Marking: 

Reference code: D66/12 1D6612S00500  
 D66/18 1D6618S00500  
 D66/42 1D6642S00500  
 D66/105 1D66105S0500

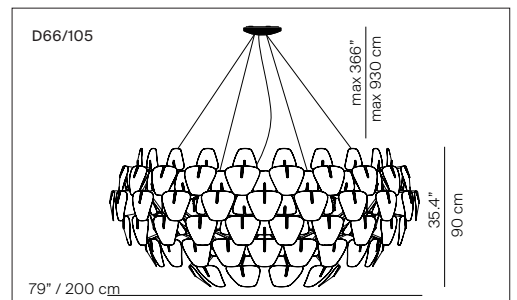
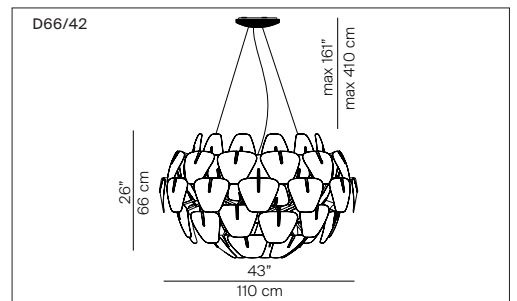
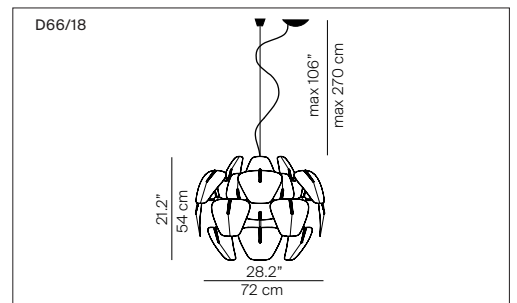
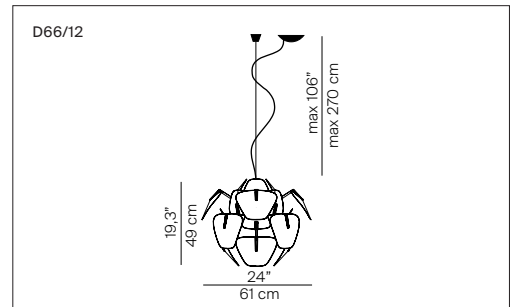

# HOPE

design Francisco Gomez Paz / Paolo Rizzato

## Composition Kit

**A**

**D66/105**

**D66/42**

**D66/42**

h tot min 400 cm

weight 23 kg

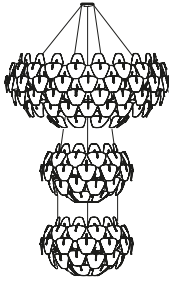

**B**

**D66/105**

**D66/18**

**D66/18**

h tot min 363 cm

weight 23 kg

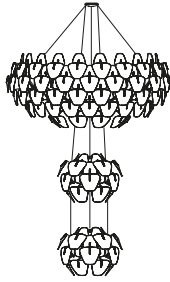

**C**

**D66/105**

**D66/18**

**D66/42**

h tot min 364 cm

weight 27,5 kg

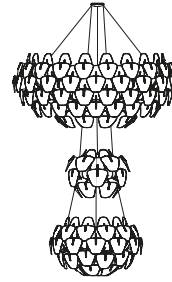

**D**

**D66/105**

**D66/42**

**D66/18**

h tot min

374 cm

weight 27,5 kg

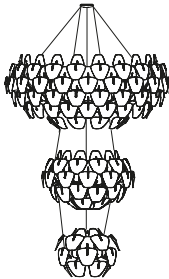

**E**

**D66/42**

**D66/105**

**D66/42**

h tot min

325 cm

weight 32 kg

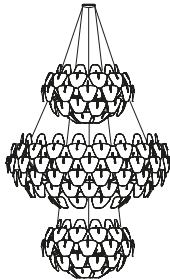

**F**

**D66/42**

**D66/105**

**D66/18**

h tot min

299 cm

weight 27,5 kg

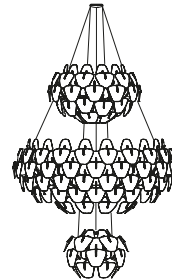

**G**

**D66/18**

**D66/105**

**D66/42**

h tot min 324 cm

weight 27,5 kg

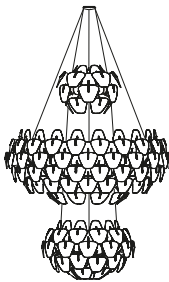

**H**

**D66/18**

**D66/42**

**D66/105**

h tot min 249 cm

weight 27,5 kg

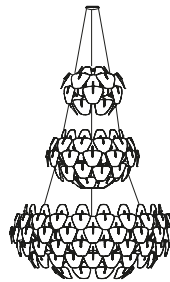

**I**

**D66/42**

**D66/42**

**D66/42**

h tot min 245 cm

weight 21 kg

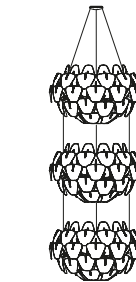

**L**

**D66/18**

**D66/18**

**D66/105**

h tot min 303 cm

weight 23 kg

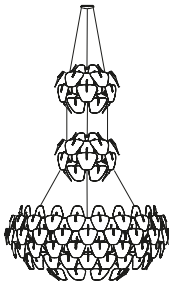

**M**

**D66/42**

**D66/42**

**D66/18**

h tot min 229 cm

weight 16,5 kg

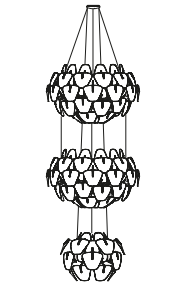

**N**

**D66/42**

**D66/18**

**D66/42**

h tot min 219 cm

weight 16,5 kg

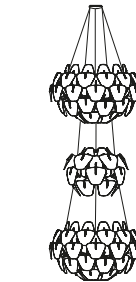

**O**

**D66/18**

**D66/42**

**D66/18**

h tot min 198 cm

weight 12 kg

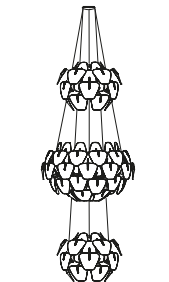

**P**

**D66/18**

**D66/18**

**D66/42**

h tot min 198 cm

weight 12 kg

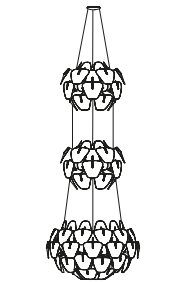

**Q**

**D66/42**

**D66/18**

**D66/18**

h tot min 213 cm

weight 12 kg

