

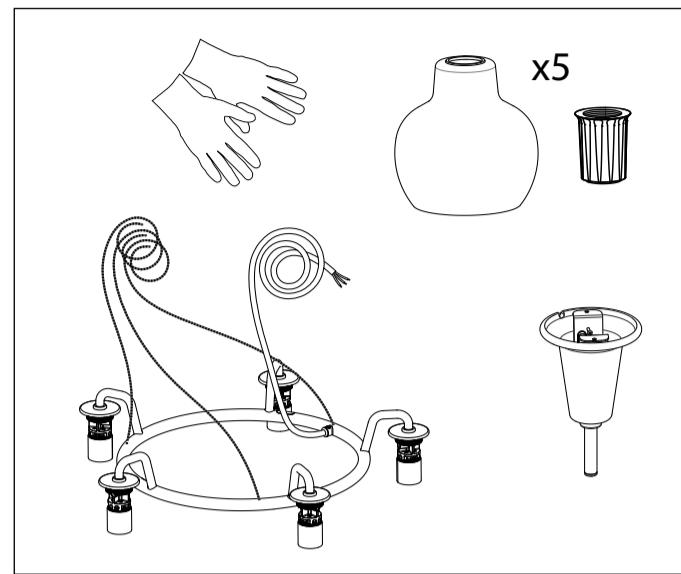

VL Ring Crown 5

Design Vilhelm Lauritzen

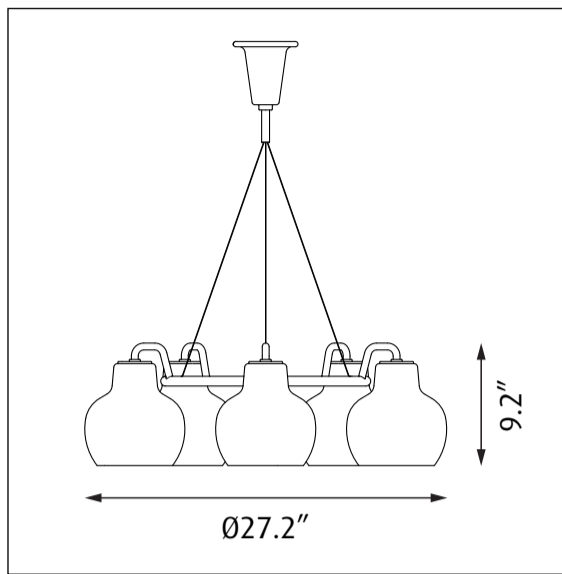

18038-12

Light source	Voltage	Weight	Electric shock protection	Ingress protection
5x 1/40W/A-21/IF medium Base 	Max. 120V	14.8 lbs	CL. II	IP20

Recommended cleaning substances:

Wipe off dust with a dry, soft cloth.

Warning: Scouring powder and similar substances will scratch surfaces.

Specifically for brass surfaces:

To maintain the shine and the light colour, clean with brass polish once or twice a year. Follow the product instructions.

Mouth-blown glass in specific: Must be cleaned in cold condition. All water must be evaporated before the lamp is lit again. The glassware in this luminaire is handcrafted. To ensure the intended lighting comfort, our glassware is blown. The process may generate air bubbles in the glass, just as its thickness may vary.

All installation is subject to local code and jurisdiction.

Consult a qualified electrician to ensure correct branch circuit conductor. The installer must ensure that the ceiling can support the luminaire's weight. The installer must if necessary reinforce the ceiling structure by adequate means.



Louis Poulsen A/S disclaims any liability if a half mirror light bulb is used. This type of light source reflects the heat and may damage/melt parts of the fixture.

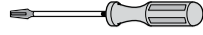
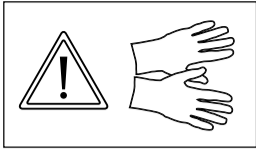

The installer must ensure to use proper means (rawplugs / screws / expansion bolts) to secure the fixture to the ceiling material. (Means not provided)
The installer must if necessary reinforce the ceiling structure by adequate means.

