

LED Exterior Garden

Ground Stake Mounting

EG64810

INSTALLATION SHEET

START FROM HERE

- Make sure **POWER** is **COMPLETELY OFF**
- Have your fixture installed by a qualified licensed electrician
- Prepare everything in a clear area
- Wear gloves at all time during this installation
- Read instructions carefully before you start assembly
- Keep this installation sheet for future reference

Please Note:

- This Kuzco LED fixture comes with pre-wired LED module(s)
- Unless instructed, Do Not touch any part of the LED module(s) as any unnecessary contact with the module could cause permanent damage
- 12V input with Outdoor Rated Low Voltage Transformer (Transformer supplied by others)
- Non-Dimming
- For typical ground stake mounting
- Luminaires shall not be installed within 10 feet of pool, spa or fountain

Technical Support: 1-855-855-8926

1. Remove fixture from its original package
2. Run fixture wire (1b) from the canopy (1a) through the mounting hole on top of the ground stake (3a)
3. Run transformer wire (provided by others) to location of intended install

Note: the low voltage wires are intended for shallow burial - less than 6 inches

4. Align fixture thread (1d) (Note: fixture thread (1d) is 1/2-14 NPT) with hole on mounting base (1f) and secure to ground stake (3a) by threading clockwise until it fits snugly. Secure mounting base (1f) to fixture (1a) with set screws (2b) and allen key

5. Fill outdoor rated wire nuts (2a) with silicone sealant (not provided). Cut and strip fixture wires (1b) and connect to transformer wire using outdoor rated wire nuts (2a) provided (Illustration 1)

Note: for multiple low-voltage garden light installation daisy-chain low voltage wire to each fixture from 12V transformer

6. Place stake (3a) in desired position and insert into ground until the flange of stake is flush with ground

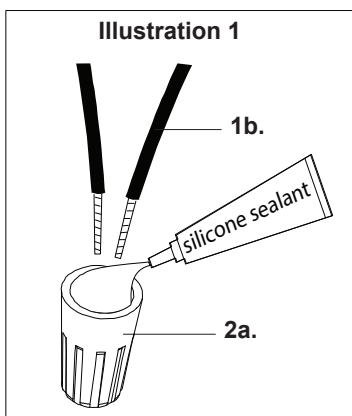
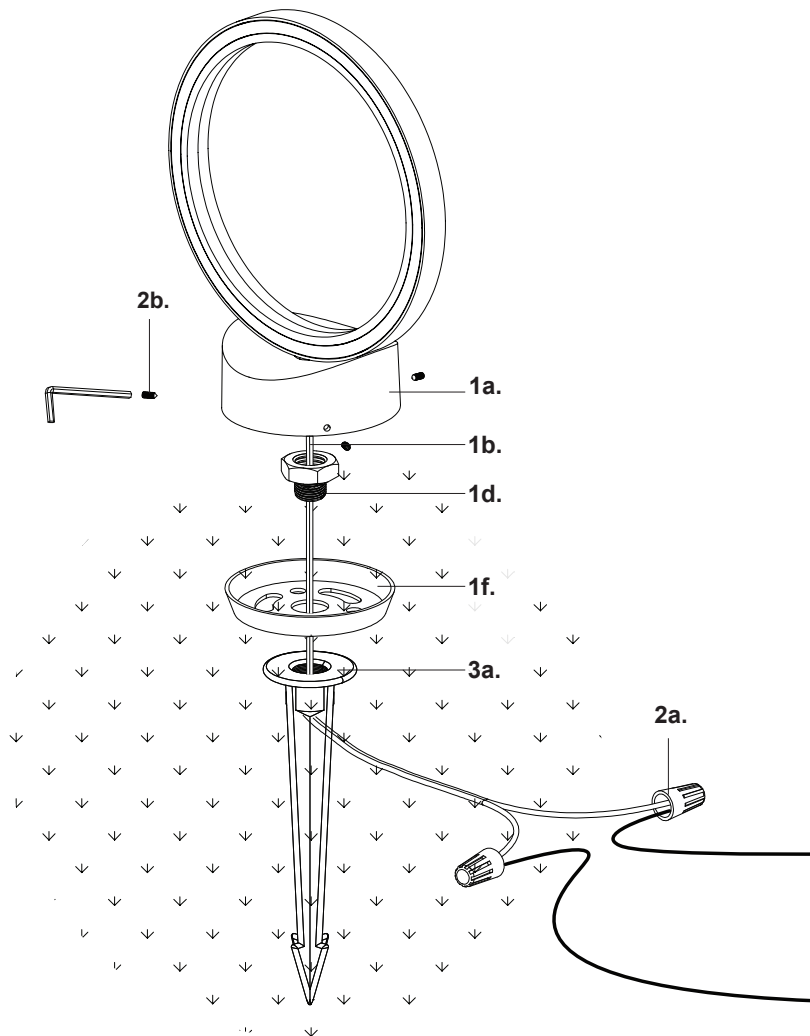

KUZCO

19054 28th Avenue Surrey, BC Canada V3Z 6M3
T: 604 538 7162 TF: 1-855 85 KUZCO F: 604 538 7196
W: kuzcolighting.com
20210427

LED Exterior Garden Hardscape Mounting

EG64810

INSTALLATION SHEET

START FROM HERE

- Make sure **POWER** is **COMPLETELY OFF**
- Have your fixture installed by a qualified licensed electrician
- Prepare everything in a clear area
- Wear gloves at all time during this installation
- Read instructions carefully before you start assembly
- Keep this installation sheet for future reference

Please Note:

- This Kuzco LED fixture comes with pre-wired LED module(s)
- Unless instructed, Do Not touch any part of the LED module(s) as any unnecessary contact with the module could cause permanent damage
- 12V input with Outdoor Rated Low Voltage Transformer (Transformer supplied by others)
- Non-Dimming
- Hardscape Mounting
- Luminaires shall not be installed within 10 feet of pool, spa or fountain

Technical Support: 1-855-855-8926

1. Remove fixture from its original package
 2. Drill holes on the hardwood and secure mounting base (1f) with screws (not provided) (Illustration 2)
 3. Run wire (1b) from the canopy (1a) and through the mounting hole on top of the ground
 4. Fill outdoor rated wire nuts (2a) with silicone sealant (not provided). Cut and strip fixture wires (1b) and connect to transformer wire using outdoor rated wire nuts (2a) provided (Illustration 1)
- Note: for multiple low-voltage garden light installation daisy-chain low voltage wire to each fixture from 12V transformer**
5. Secure canopy (1a) to mounting base (1f) with set screw (2b) and allen key provided

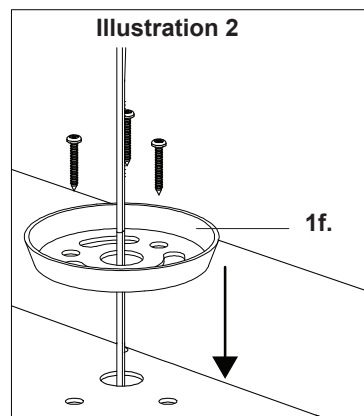
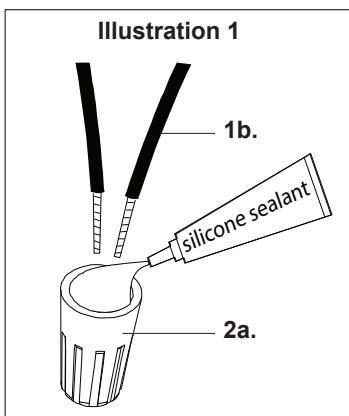
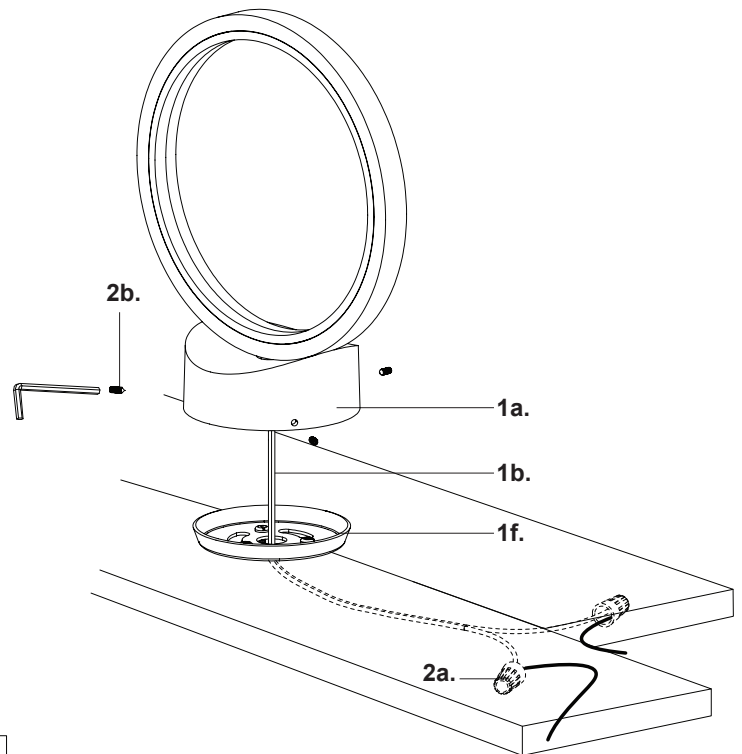

KUZCO

19054 28th Avenue Surrey, BC Canada V3Z 6M3
T: 604 538 7162 TF: 1-855 85 KUZCO F: 604 538 7196
W: kuzcolighting.com
20210427