

LED Exterior Wall Sconce

EW3107
INSTALLATION SHEET

START FROM HERE

- Make sure **POWER** is **COMPLETELY OFF** at the fuse box
- Have your fixture installed by a qualified licensed electrician
- Prepare everything in a clear area
- Wear gloves at all time during this installation
- Read instructions carefully before you start assembly
- Keep this installation sheet for future reference

Please Note:

- This Kuzco LED fixture comes with pre-wired LED module(s)
- Unless instructed, Do Not touch any part of the LED module(s) as any unnecessary contact with the module could cause permanent damage
- Use ELV (Electronic Low Voltage) type of dimmer for dimming application
- 120V input

Technical Support: 1-855-855-8926

- 1.** Remove the fixture from its original packaging
- 2.** Separate the mounting plate (**1c**) from the canopy (**2a**) by removing the set screws (**2f**) with allen key
- 3.** Attach mounting plate (**1c**) to electrical junction box (**1a**) using junction box screws provided (**1e**) in hardware package
- 4.** Make proper electrical connections (**black to hot "L"**, **white to neutral "N"**, **ground to "GND"**) with wire nuts (**1b**) provided in hardware package
- 5.** Secure canopy (**2a**) to mounting plate (**1c**) with set screws (**2f**) and allen key

- 6.** To prevent moisture from entering the outlet box and causing a short, seal around the top and side perimeter between the fixture and the wall surface with weather resistant caulking (**see illustration 1**). The space at bottom should be left un-caulked to prevent moisture build-up.

Illustration 1

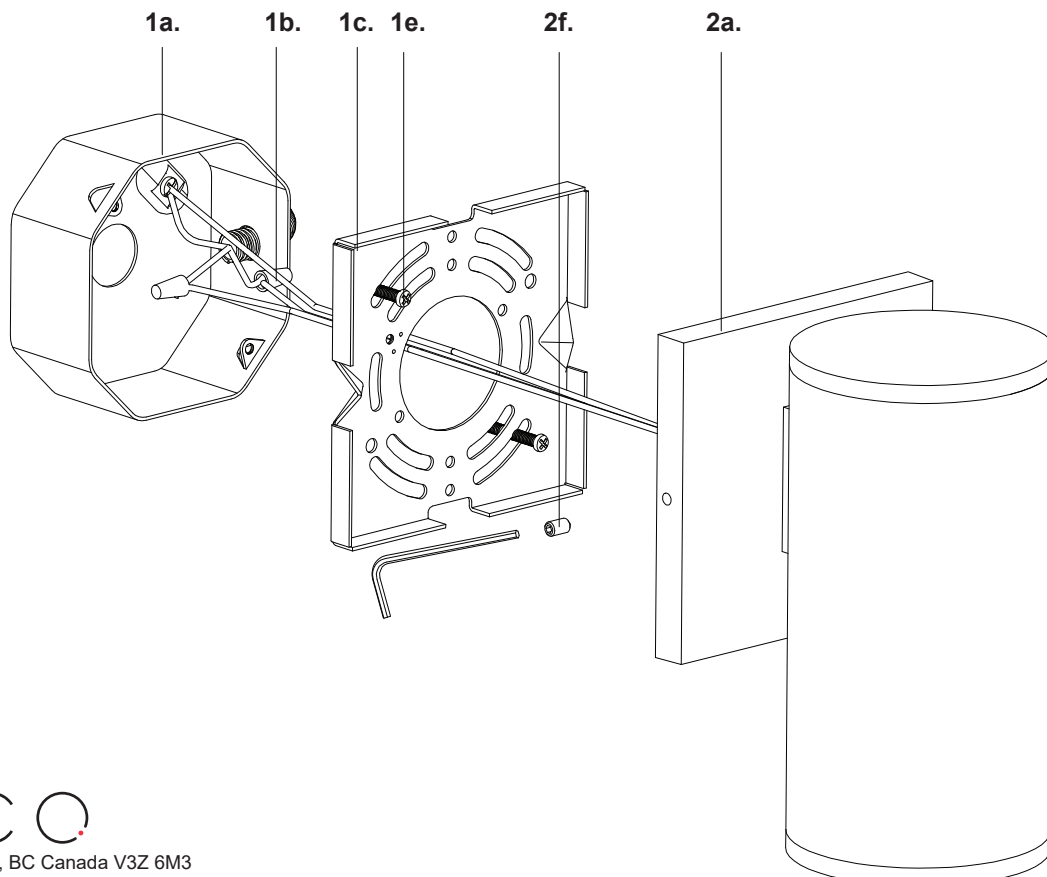
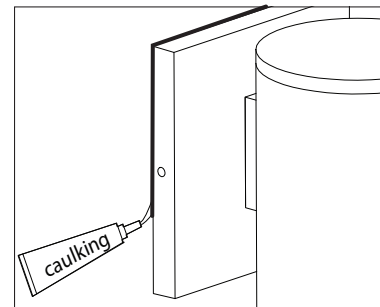

KUZCO

19054 28th Avenue Surrey, BC Canada V3Z 6M3
T: 604 538 7162 TF: 1-855 85 KUZCO F: 604 538 7196
W: kuzcolighting.com
20201119