

All-terrior LED Lamp Wall Sconce

AT6610
INSTALLATION SHEET

START FROM HERE

- Make sure power is completely off at the fuse box.
- Have your fixture installed by a qualified licensed electrician
- Prepare everything in a clear area.
- Wear gloves at all times during this installation.
- Read instructions carefully before you start assembly.
- Keep this instruction sheet for future reference.

Technical Support: 1-855-855-8926

Please Note:

- All Kuzco LED fixtures come with pre-wired LED module(s).
- Unless instructed to do so, please do not touch any part of the LED module(s) as any unnecessary contact with the module could cause permanent damage.
- For dimming, an ELV (Electronic Low Voltage) type of dimmer is required.

- 1.** Remove the fixture from its original packaging. Remove the mounting plate (1c) from within the canopy backplate (2a) by loosening the four set screws (2d) and two screws (2b). Secure the mounting plate (1c) to the junction box (1a) with screws (1d) provided in the hardware package.
- 2.** Attach the canopy backplate (2a) to the mounting plate (1c), which is attached to the electrical junction box (1a) on the wall. First attach all wiring with the provided marrettes (1b) (white to white "N", black to black "L", ground to ground "G"). Now direct the canopy backplate (2a) onto the mounting plate (1c) be sure to line up the mounting threaded holes with the screws (2b). Next, place the canopy (2c) onto the canopy backplate (2a) and secure with all four set screws (2d) turning clockwise.
- 3.** *FOR OUTDOOR OPTION ONLY*
To prevent moisture from entering the outlet box and causing a short, seal around the top and side perimeter between the fixture and the wall surface with weather resistant caulking (see Outdoor Option). The space at bottom should be left un-caulked to prevent moisture.
- 4.** You have now completed the installation of your fixture, enjoy.

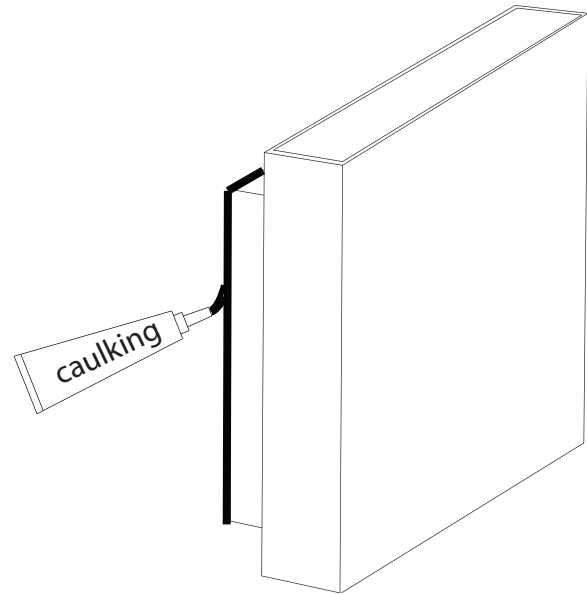

Outdoor Option

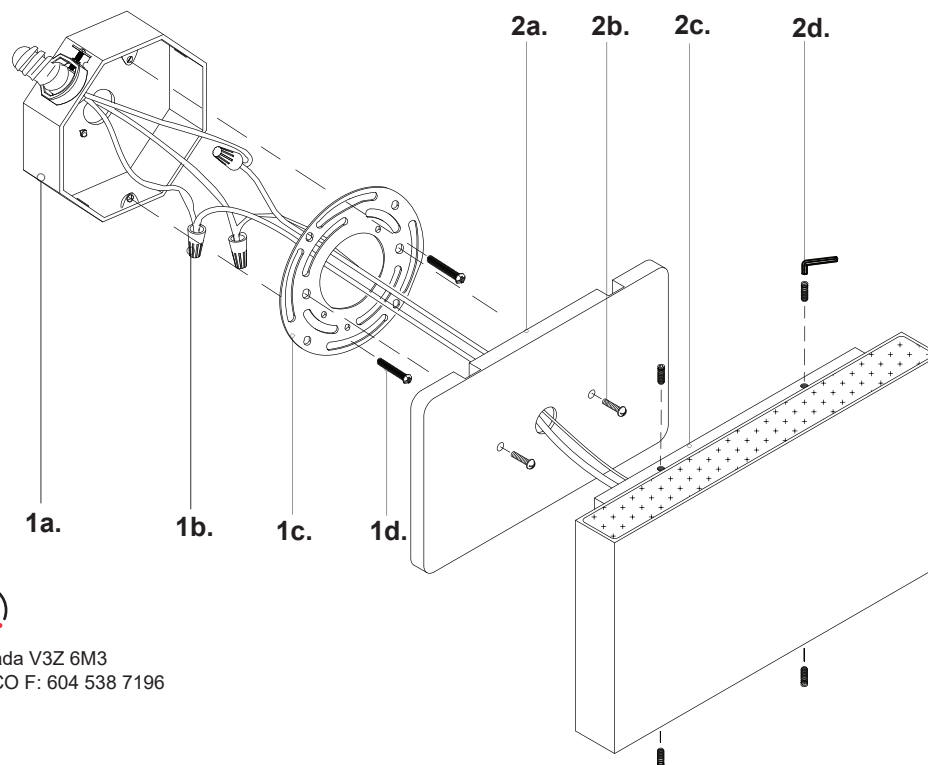

KUZCO

19054 28th Avenue Surrey, BC Canada V3Z 6M3
T: 604 538 7162 TF: 1-855 85 KUZCO F: 604 538 7196
W: kuzcolighting.com
20181127