

LED Exterior Garden

Ground Stake Mounting

EG26730
INSTALLATION SHEET

START FROM HERE

- Make sure **POWER** is **COMPLETELY OFF**
- Have your fixture installed by a qualified licensed electrician
- Prepare everything in a clear area
- Wear gloves at all time during this installation
- Read instructions carefully before you start assembly
- Keep this installation sheet for future reference

Please Note:

- This Kuzco LED fixture comes with pre-wired LED module(s)
- Unless instructed, Do Not touch any part of the LED module(s) as any unnecessary contact with the module could cause permanent damage
- 12V input with Outdoor Rated Low Voltage Transformer (Transformer supplied by others)
- Non-Dimming
- For typical ground stake mounting
- Luminaires shall not be installed within 10 feet of pool, spa or fountain

Technical Support: 1-855-855-8926

- 1.** Remove fixture from its original package
- 2.** Run fixture wire (**1b**) from the fixture (**1a**) through the mounting hole on top of the ground stake (**3a**)
- 3.** Run transformer wire (provided by others) to location of intended install

Note: the low voltage wires are intended for shallow burial - less than 6 inches

- 4.** Attach fixture thread (**1d**) (**Note: fixture thread (1d) is 1/2-14 NPT**) to ground stake (**3a**) by threading clockwise until it fits snugly

- 5.** Fill outdoor rated wire nuts (**2a**) with silicone sealant (not provided) .Cut and strip fixture wires (**1b**) and connect to transformer wire using outdoor rated wire nuts (**2a**) provided (**Illustration 1**)

Note: for multiple low-voltage garden light installation daisy-chain low voltage wire to each fixture from 12V transformer

- 6.** Place stake (**3a**) in desired position and insert into ground until the flange of stake is flush with ground

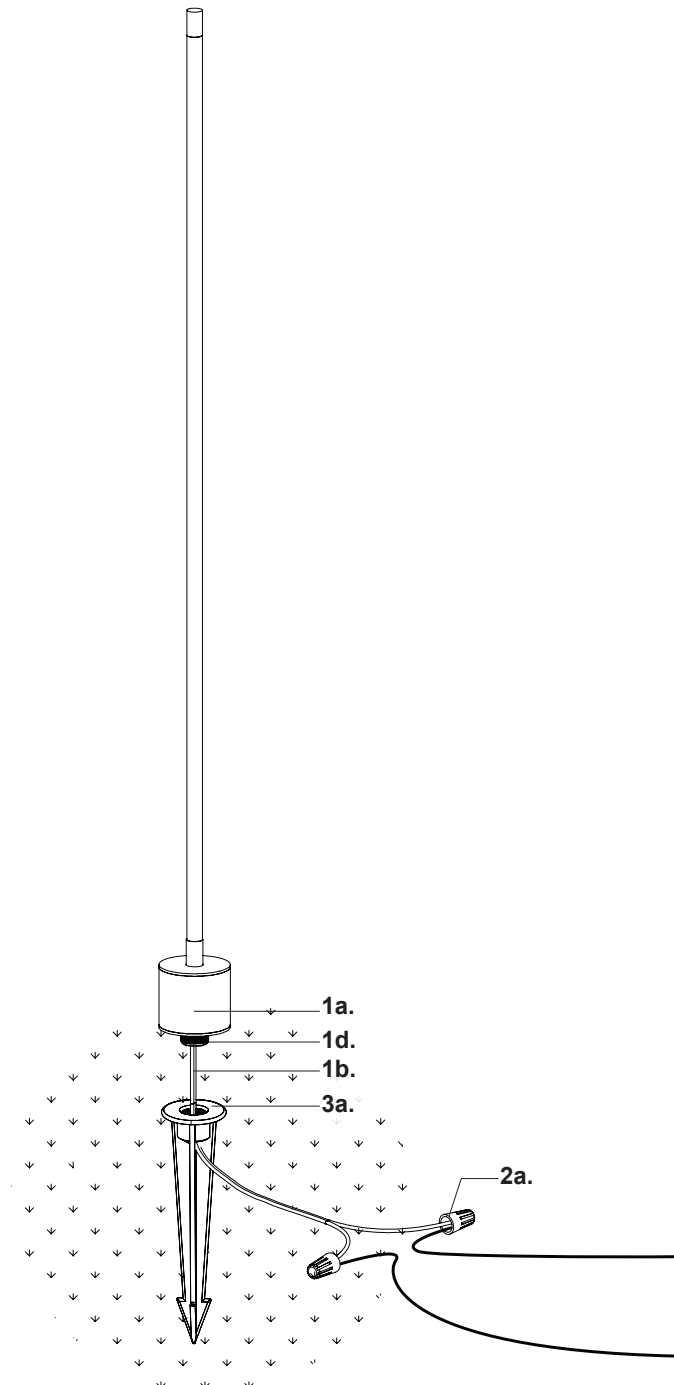
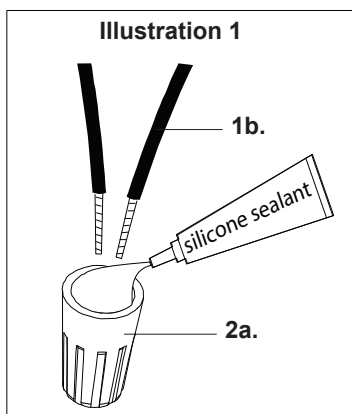

KUZCO

19054 28th Avenue Surrey, BC Canada V3Z 6M3
T: 604 538 7162 TF: 1-855 85 KUZCO F: 604 538 7196
W: kuzcolighting.com
20210422