

LED Wall Sconce

WS70124

INSTALLATION SHEET

START FROM HERE

- Make sure **POWER** is **COMPLETELY OFF** at the fuse box
- Have your fixture installed by a qualified licensed electrician
- Prepare everything in a clear area
- Wear gloves at all time during this installation
- Read instructions carefully before you start assembly
- Keep this installation sheet for future reference

Technical Support: 1-855-855-8926

Please Note:

- This Kuzco LED fixture comes with pre-wired LED module(s)
- Unless instructed, Do Not touch any part of the LED module(s) as any unnecessary contact with the module could cause permanent damage
- Use ELV (Electronic Low Voltage) or TRIAC type of dimmer for dimming application

1. Remove the fixture from its original packaging
2. Separate the mounting plate (1c) from the canopy (2a) by removing the four screws (2c) with allen key
3. Attach the mounting plate (1c) to the electrical junction box (1a) using the two screws (1d) provided in the hardware package (**Note:** keep back plate level when mounting to octagon box with leveling marks as guide)

4. Make proper electrical connections (**black** to hot "L", **white** to neutral "N", **ground** to "GND") with wire nuts (1b) provided in hardware package
5. Attach canopy (2a) to mounting plate (1c) with screws (2c) using allen key
6. Gently slide LED assembly (4f) into glass tube (4a) until connector receptacles (4b) can be exposed through on glass, secure by installing end caps (4e)
7. Insert rubber wave washer (4c), followed by flat washer (4d) onto each connector receptacle (4b) post, and then insert coaxial connector (3c) to make electrical connection, secure with threaded cap (3d)

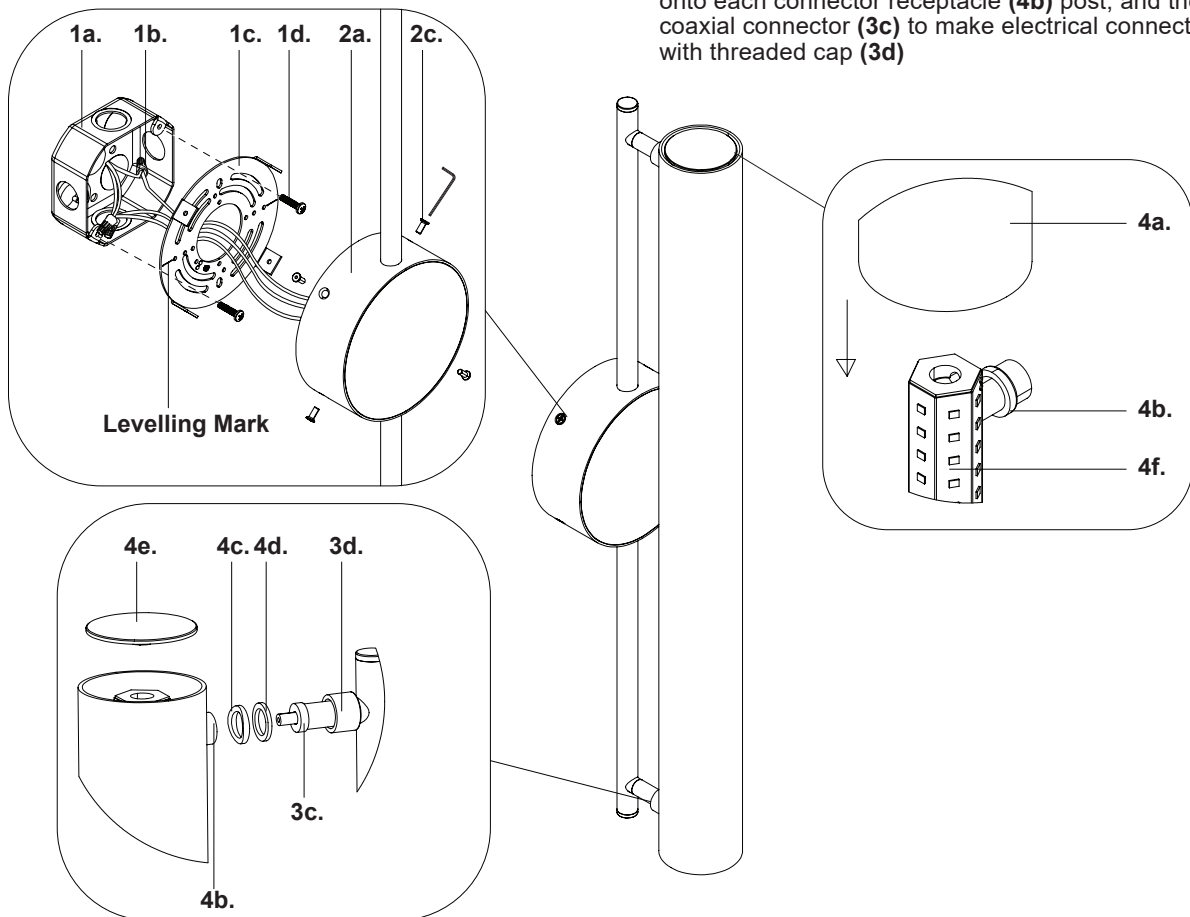

KUZCO

19054 28th Avenue Surrey, BC Canada V3Z 6M3
T: 604 538 7162 TF: 1-855 85 KUZCO F: 604 538 7196
W: kuzcolighting.com
20200623