

ULULÌ E ULULÀ

SE649GB-EXT
SE649GG-EXT



SE6498PB-EXT
SE648PG-EXT

220-240 V.

max 1x105W - E27 (a)

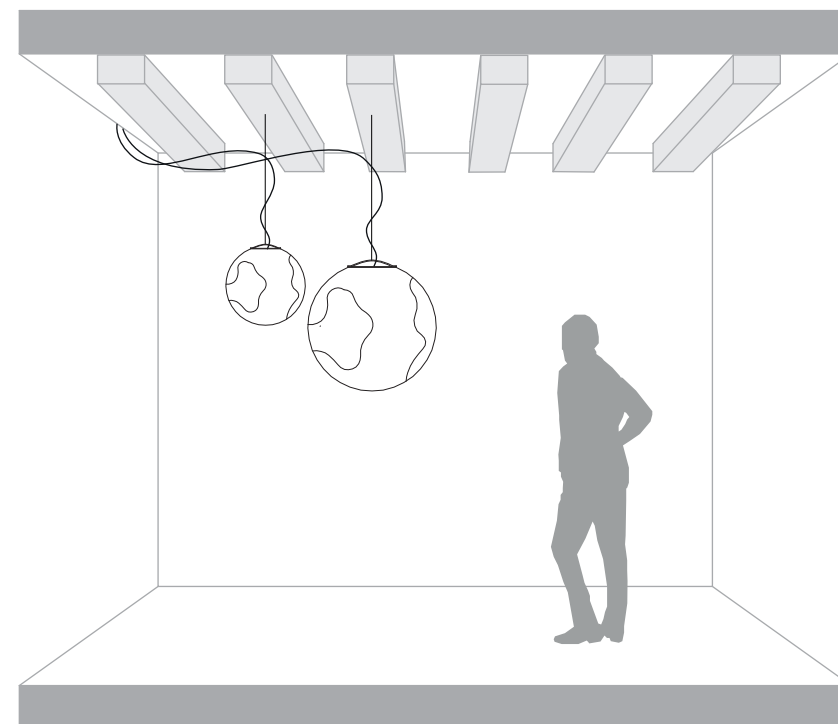
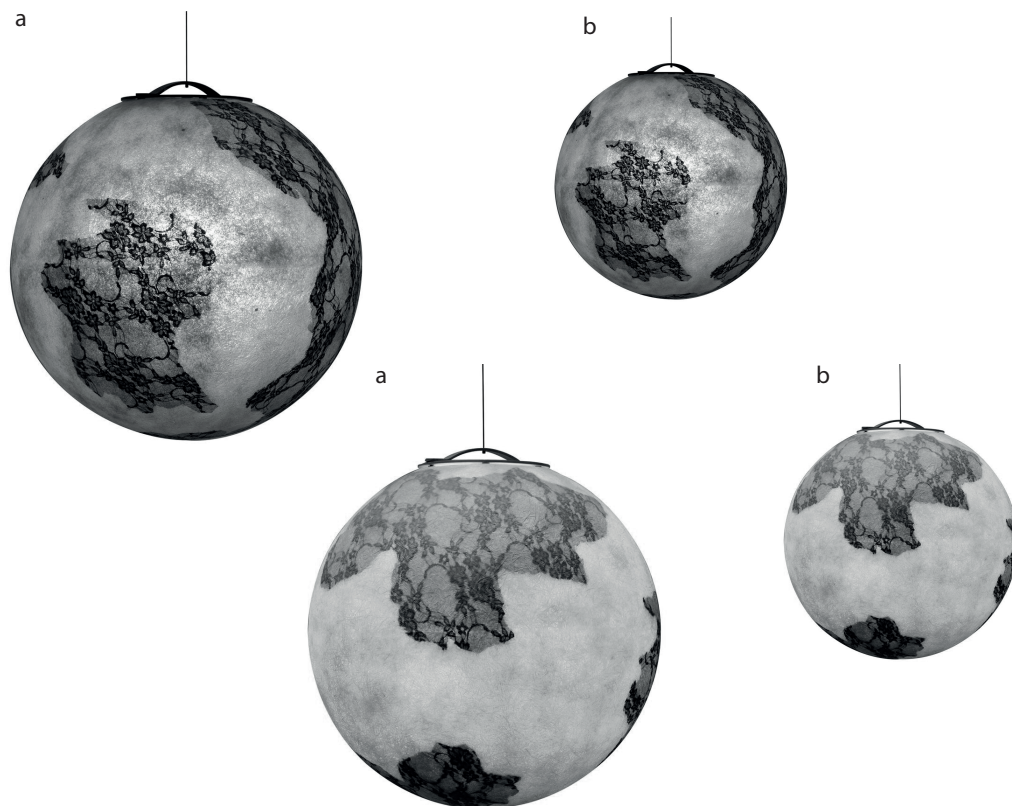
max 1x70W - E27 (b)

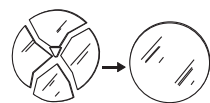

IP65   

Karman srl

Via A. Grandi, San Martino del piano, 61034 Fossombrone (PU), Italy - p.iva 02175640412 tel +39 0721 71 5042 r.a fax +39 0721 716640 - www.karmanitalia.it

IT _Se il cavo flessibile esterno di quest'apparecchio viene danneggiato, deve essere sostituito dal costruttore o dal servizio di assistenza o da personale qualificato equivalente al fine di evitare pericoli.
-Togliere tensione prima dell'installazione o di qualsiasi manutenzione.
-Il prodotto deve essere montato da personale qualificato, rispettando le norme impianti in vigore.

Attenzione! Apparecchio artistico, tenere lontano dalla portata dei bambini.

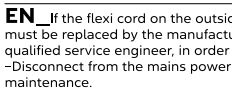

Attenzione! Rischio scossa elettrica. Togliere la tensione elettrica in assenza di lampadina.

EN _If the flexi cord on the outside of this appliance becomes damaged, it must be replaced by the manufacturer or by its assistance service or a qualified service engineer, in order to avoid all hazard risks.
-Disconnect from the mains power before installing or carrying out any maintenance.
-This item must be fitted by a qualified person, compliant with current installation regulations.

Warning! Artistic appliance. Keep out of the reach of children.

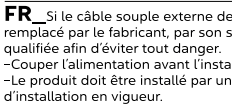

Warning! Electric shock risk. Disconnect from the mains power if no light bulb is fitted.

FR _Si le câble souple externe de cet appareil est endommagé, il doit être remplacé par le fabricant, par son service d'assistance ou par une personne qualifiée afin d'éviter tout danger.
-Couper l'alimentation avant l'installation ou toute opération d'entretien.
-Le produit doit être installé par un personnel qualifié, en respectant les règles d'installation en vigueur.

Attention! Cet appareil n'est pas un jeu, tenir hors de la portée des enfants.

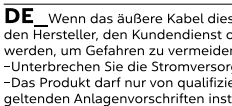

Attention! Risque de choc électrique. Couper l'alimentation électrique en l'absence d'ampoule.

DE _Wenn das äußere Kabel dieses Gerätes beschädigt wird, muss es durch den Hersteller, den Kundendienst oder ähnlich qualifizierte Personen ersetzt werden, um Gefahren zu vermeiden.
-Unterbrechen Sie die Stromversorgung vor der Installation oder Wartung.
-Das Produkt darf nur von qualifizierten Personen und unter Beachtung der geltenden Anlagenvorschriften installiert werden.

Achtung! Kein Spielzeug. Bitte von Kindern fernhalten.

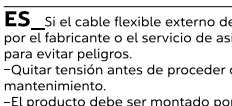

Achtung! Stromschlaggefahr. Unterbrechen Sie die Stromversorgung, falls keine Glühlampe eingeschraubt ist.

ES _Si el cable flexible externo de este aparato se daña debe ser sustituido por el fabricante o el servicio de asistencia o personal cualificado equivalente para evitar peligros.
-Quitar tensión antes de proceder con la instalación o cualquier trabajo de mantenimiento.
-El producto debe ser montado por personal cualificado de conformidad con las normas vigentes para instalaciones.

¡Atención! Aparato artístico, mantener alejado del alcance de los niños.

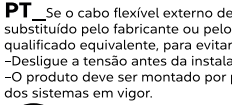

¡Atención! Riesgo de choque eléctrico. Desconectar la tensión eléctrica en ausencia de bombilla.

PT _Se o cabo flexível externo deste aparelho for danificado, deve ser substituído pelo fabricante ou pelo serviço de assistência ou por pessoal qualificado equivalente, para evitar perigos.
-Desligar a tensão antes da instalação ou qualquer operação de manutenção.
-O produto deve ser montado por pessoal qualificado, respeitando as normas dos sistemas em vigor.

Atenção! Aparelho artístico, manter longe do alcance das crianças.



Atenção! Risco de choque elétrico. Desligar a tensão elétrica na ausência de lâmpada.

NL _Om gevaar te vermijden moet de externe flexibele kabel van dit apparaat, indien beschadigd, door de fabrikant, zijn technische dienst of equivalent bevoegd personeel vervangen worden.
-Voor elke installatie of onderhoudswerkzaamheid de spanning afsluiten.
-Het product moet door bevoegd personeel gemonteerd worden met inachtname van de geldende normen.

Aandacht! Art apparaat, uit de buurt van kinderen houden.



Aandacht! Gevaar voor elektrische schokken. Als geen lamp aanwezig is de stroom afsluiten.

SV _Om apparatets sladd skadas ska den för förhånds risker bytas ut av tillverkaren, kundservice eller likvärdig kvalificerad personal.
-Koppla alltid bort spänningen innan installation eller underhållsarbete.
-Produkten ska monteras av kvalificerad personal som ska följa gällande anläggningsföreskrifter.

Observera! Detta är ett konstföremål, inte en leksak, och ska förvaras utom räckhåll för barn.

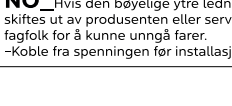

Observera! Risk för elstötk. Koppla bort den elektriska spänningen när det saknas lampor.

NO _Hvis den bøyelige ytre ledningen ved dette apparatet skades, må den skiftes ut av produsenten eller servicetjenesten eller av tilsvarende kvalifisert fagfolk for å kunne unngå farer.
-Koble fra spenningen før installasjon eller ethvert vedlikeholdsinngrep.

-Produktet må være montert av kvalifisert fagfolk, mens de gjeldene lovforholdene overholdes.

Advarsel! Kunstnerisk apparat, må holdes utenfor barns rekkevidde.

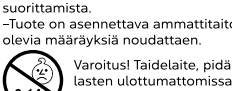

Advarsel! Fare for elektrisk støt. Koble fra den elektriske spenningen hvis lyspæren mangler.

FI _Jos tämän laitteen ulkopuolinen johto vahingoittuu, vaarojen välttämiseksi se on annettava vaihdettavaksi valmistajalle tai huoltopalvelulle tai vastaavan ammattitaitoinen omaavalle henkilökunnalle.
-Poista jännite ennen asennusta tai ennen minkä tahansa huoltoimenpiteen suorittamista.
-Tuote on asennettava ammattitaitoisen henkilökunnan toimesta voimassa olevia määräyksiä noudattaen.

Varoitus! Taidelaitte, pidä lasten ulottumattomissa.

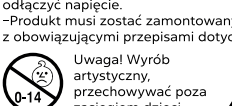

Varoitus! Sähköiskuvaara. Poista sähköjännite, kun laitteessa ei ole lampua.

PL _Jeżeli przewód giętki na zewnątrz urządzenia zostanie uszkodzony, ze względów bezpieczeństwa muszą zostać wymienione przez producenta, serwisu techniczny lub osobę o równorzędnych kwalifikacjach.
-Przed przystąpieniem do instalacji lub jakiegokolwiek czynności konserwacyjnej odłączaj napięcie.
-Produkt musi zostać zamontowany przez wykwalifikowany personel zgodnie z obowiązującymi przepisami dotyczącymi instalacji.

Uwaga! Wyrób artystyczny, przechowywać poza zasięgiem dzieci.

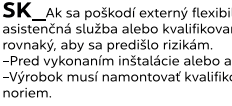

Uwaga! Niebezpieczeństwo porażenia prądem. W przypadku braku żarówki odłączyć od napięcia elektrycznego.

CS _V případě poškození externího kabelu tohoto svítidla musíte zajistit jeho výměnu prostřednictvím výrobce, technického servisu nebo kvalifikovaného technika, aby nedošlo k žádným nebezpečným situacím.
-Před instalací a údržbou odpojte od přívodu elektrického proudu.
-Výrobek musí namontovat kvalifikovaný technik za dodržení platných předpisů.

Pozor! Umělecké svítidlo. Uchovávejte mimo dosah dětí.

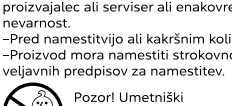

Pozor! Nebezpečí zásahu elektrickým proudem. Po sejmутí žárovky odpojte svítidlo od přívodu elektrického proudu.

SK _Ak sa poškodí externý flexibilný kábel tohto svietidla, výrobca alebo asistenčná služba alebo kvalifikovaný pracovník musí vykonať jeho výmenu za rovnaký, aby sa predišlo rizikám.
-Pred vykonaním inštalácie alebo akejkoľvek údržby odpojte napätie.
-Výrobok musí namontovať kvalifikovaný pracovník s dodržaním, platných noriem.

Upozornenie! Meleček svietidlo, držte ho z dosahu detí.

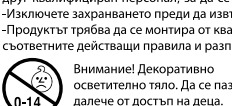

Upozornenie! Riziko zasiahnutia elektrickým prúdom. Ak sa v prístroji nenachádza žiarovka, vypnite elektrický prúd.

SL _Če se zunanji prožni kabel naprave poškoduje, ga mora zamenjati proizvajalec ali serviser ali enakovredno usposobljeno osebe in tako preprečiti nevarnost.
-Pred namestitvijo ali kakršnim koli vzdrževanjem izklopite napajanje.
-Proizvod mora namestiti strokovno usposobljena oseba ob upoštevanju veljavnih predpisov za namestitve.

Pozor! Umetniški izdelek hranite izven dosega otrok.

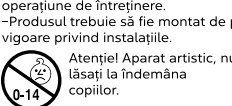

Pozor! Nevarnost električnega udara. Izklopite napajanje, če žarnica ni vstavljenja.

BG _Ако външният гъвкав кабел на това осветително тяло бъде повреден, той трябва да се подмени от производителя, от центъра за обслужване на клиенти или от друг квалифициран персонал, за да се избегнат евентуални рискове.
-Изключете захранването преди да извършвате операции по монтаж или поддръжка.
-Продуктът трябва да се монтира от квалифициран персонал при спазване на съответните действащи правила и разпоредби.

Внимание! Декоративно осветелно тяло. Да се пази далеч от достъп на деца.

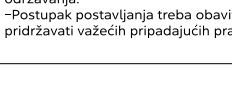

Внимание! Риск от токов удар. Изключете захранването при липса на електрическа крушка.

RO _In situația în care cablul flexibil exterior al acestui aparat este deteriorat, este necesar să fie înlocuit de producător sau de serviciul de asistență ori de personal calificat echivalent, pentru prevențmpinarea pericolelor.
-Înterupeți alimentarea cu tensiune mai înainte de instalare sau de orice operațiune de întreținere.
-Produsul trebuie să fie montat de personal calificat, conform standardelor în vigoare privind instalațiile.

Atenție! Aparat artistic, nu lăsați în ademență copiiilor.



Atenție! Risc de electrocutare. Întrerupeți alimentarea cu tensiune electrică în lipsa becului.

Pažnja! Budući da je riječ o zanimljivom uređaju, držite ga izvan dosega djece.

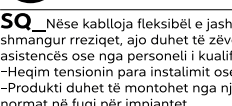

Pažnja! Rizik od strujnog udara. Isključite napajanje ako nema žarulje.

SQ _Nëse kablloja fleksibël e jashtme e kësaj pajisje dëmtohet, për të shmangur rreziket, ajo duhet të zëvendësohet nga konstruktori, shërbimi i asistencës ose nga personeli i kualifikuar ekuivalent.
-Heqim tensionin para instalimit ose para çdolloj mirëmbajtje.
-Produkti duhet të montohet nga një personel i kualifikuar, duke respektuar normat në fuqi për impiantet.

KUJDESI! Pajisje artistike, duhet mbajtur larg nga vendet që arrihen nga fëmijët.

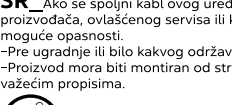

KUJDESI! Rrezik goditje elektrike. Kur lamba nuk është e montuar, duhet të shkëputim furnizimin me energji elektrike.

Pažnja! Umetnički komad. Držite ga dalje od dohvata dece.

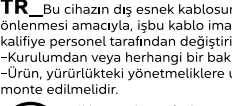

Pažnja! Rizik od strujnog udara. Isključiti iz struje kada u uređaju nema sijalice.

Pažnja! Dekorativní přístroj, uchovávejte mimo dosah dětí.

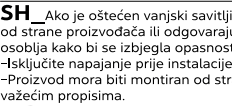

Dikkat! Dekoratif cihaz, çocukların ulaşamayacağı yerlerde saklayınız.

Upozorenje! Umjetnički uređaj, držati podalje od dece.

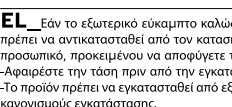

Upozorenje! Rizik od strujnog udara. Isključite napajanje strujom u odsustvu sijalice.

Προσοχή! Καλλιτεχνική συσκευή, να φυλάσσεται μακριά από παιδιά.

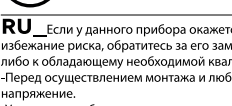

Προσοχή! Ένδεχο κίνδυνος ηλεκτροπληξίας. Αποσυνδέστε την παροχή ηλεκτρικού ρεύματος σε περίπτωση απουσίας του λαμπτήρα.

Внимание! Данное художественное изделие необходимо хранить в недоступном для детей месте.

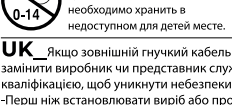

Внимание! Риск поражения электрическим током. При отсутствии лампыч отключайте электронапряжение.

Увага! Художній виріб. Тримати подаль від дітей.

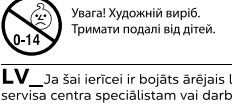

Увага! Небезпека ураження електричним струмом. Від'єднати світільник від джерела живлення якщо електрична лампочка відсутня.

Pažnja! Umjetnički komad, držati podalje od dece.

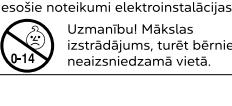

Uzmanbil! Elektriskās strāvas triecienu risks. Atslēdziet strāvas padevi, ja nav uzstādīta spuldze.

LT _Jei išorinis lankstus šio prietaiso laidas yra pažeistas, ji turi pakeisti gamintojas, techninės priežiūros paslaugų teikėjai arba atitinkami kvalifikuoti darbuotojai, kad būtų išvengta pavojų.
-Prieš įrengimą ar bet kokią techninę priežiūrą išjunkiterovės šaltinį.
-Gaminį turi įrengti kvalifikuoti darbuotojai, laikymąsi galiojančių įrenginių įrengimo taisyklių.

Atsargiai! Tai meninis įrenginys, saugoti nuo vaikų.

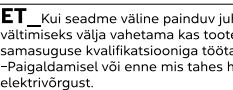

Atsargiai! Elektros smūgio pavojus. Nesant lemputės, išjunkiterovės šaltinį.

ET _Kui seadme välise paindud juhe saab kahjustada, peab selle ohtude vältimiseks välja vahetama kas toote valmistajata, teeninduskeskus või samasuguse kvalifikatsiooniga töötajata.
-Paigaldamisel või enne mis tahes hoolduse tegemist eemaldage seade elektrivõrgust.
-Tuote tohib paigaldada ainult asjakohaste kutseoskustega töötajata, kes järgib seadmete teavitada ettekirjutusi.

Tähelepanu! See on kunstiline seade, mitte mänguasi. Hoida lastele kättesaamatus kohas.

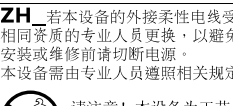

Tähelepanu! Elektrilöögi oht. Kui elektripirn ei ole paigaldatud, siis ärge seadeti elektrivõrku ühendage.

ZH _若本设备的外接柔性电缆受损，必须由制造商、售后服务方或具有相同资质的专业人员更换，以避免发生事故。
安装或维修前请切断电源。
本设备需由专业人员遵照相关规定进行安装。
请注意！小心触电。无灯时请务必切断电源。

请注意！小心触电。无灯时请务必切断电源。

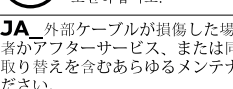

请注意！设计师的意图，请勿更改。设计师的意图，请勿更改。设计师的意图，请勿更改。

JA _外部ケーブルが損傷した場合の交換は、危険を避けるため、生産者かアフターサービス、または同等の有資格者が行ってください。取り替えを含むあらゆるメンテナンスをする際は、必ず電源をお切りください。
組み立てる際は取扱説明書に従い、有資格者が行ってください。
注意！デザイン器具ですので、お子様の手の届かないところでご使用ください。

注意！デザイン器具ですので、お子様の手の届かないところでご使用ください。

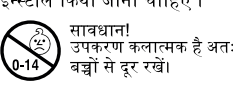

注意！感電の恐れがあります。電源をお切りください。

HI _खतरे से बचने के लिए उपकरण का क्षतिग्रस्त वाहरी लचीला तार निमाता या विक्री के उपरान्त सर्विस कर्मचारियों द्वारा ही बदला जाना चाहिए। तार बदलने के पहले या रखरखाव के किसी भी कार्य से पहले बिजली बंद कर दें। प्रोडक्ट योग्य कर्मचारियों द्वारा ही नियमानुसार तरीकेसे इस्टॉल किया जाना चाहिए।
सावधान! उपकरण क्लासिक है अतः बच्चों से दूर रखें।
सावधान! बिजली के झटके का खतरा है। बल्ब न होने पर बिजली की आपूर्ति काट दें।

HE _אם הכבל הגמיש החיצוני של התקנת הוצרן הירצן, על ידי אנשים מוסמכים בלבד, בהתאם לתקנות הנוהגות בנושא מוסמכים.

AR _إذا تعرض السلك الخارجي المرمن للجهاز إلى التلف فيجب استبداله من قبل الشركة المصنعة أو مركز خدمة المساعده أو من قبل عمال مؤهلون من ذوي الخبرة، وذلك تجنباً للتعرض إلى المخاطر، يجب فصل المنتج عن التيار الكهربائي عند التركيب وعند القيام بأية عملية من عمليات الصيانة.
يجب أن يقوم عمال مؤهلون بتفكيك المنتج ويجب أن يتم هذا بالاستناد إلى التوجيهات السارية الخاصة بالأجهزة.
تنبيه! خطر الإصابة بالصعق الكهربائي يجب فصل الجهاز عن التيار الكهربائي عند عدم وجود المصباح الكهربائي.
تنبيه! هذا الجهاز هو قطعة فنية ويجب الاحتفاظ بها بعيداً عن متناول أيدي الأطفال.

تنبيه! هذا الجهاز هو قطعة فنية ويجب الاحتفاظ بها بعيداً عن متناول أيدي الأطفال.

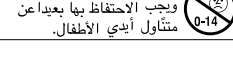

تنبيه! خطر الإصابة بالصعق الكهربائي يجب فصل الجهاز عن التيار الكهربائي عند عدم وجود المصباح الكهربائي.

C - 01

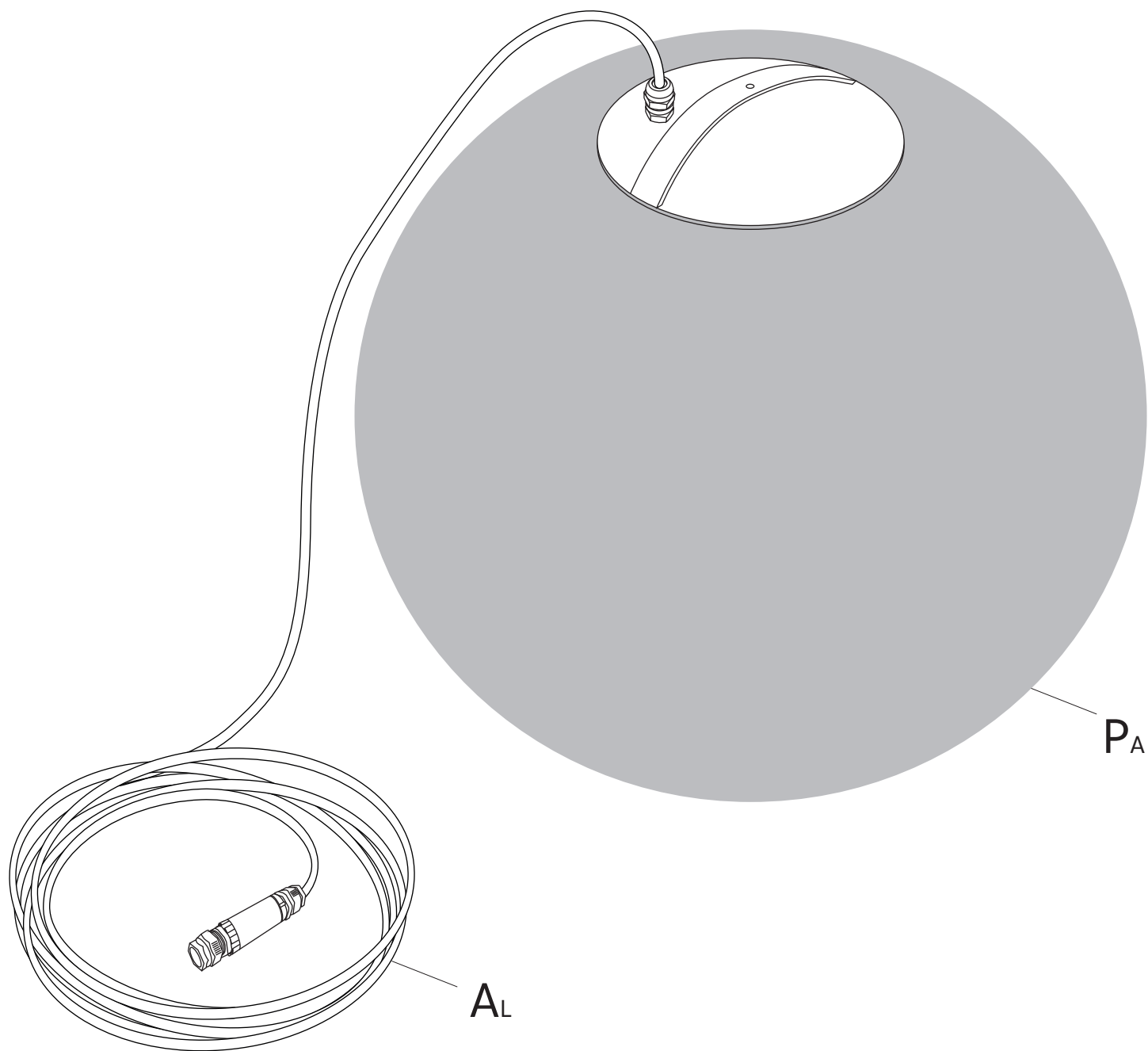

1x B_a

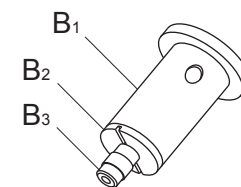

1x F

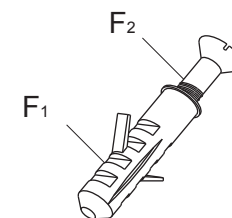

1x C_a

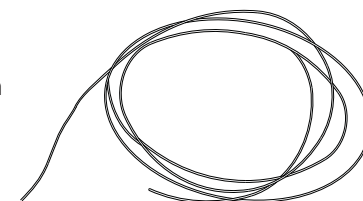

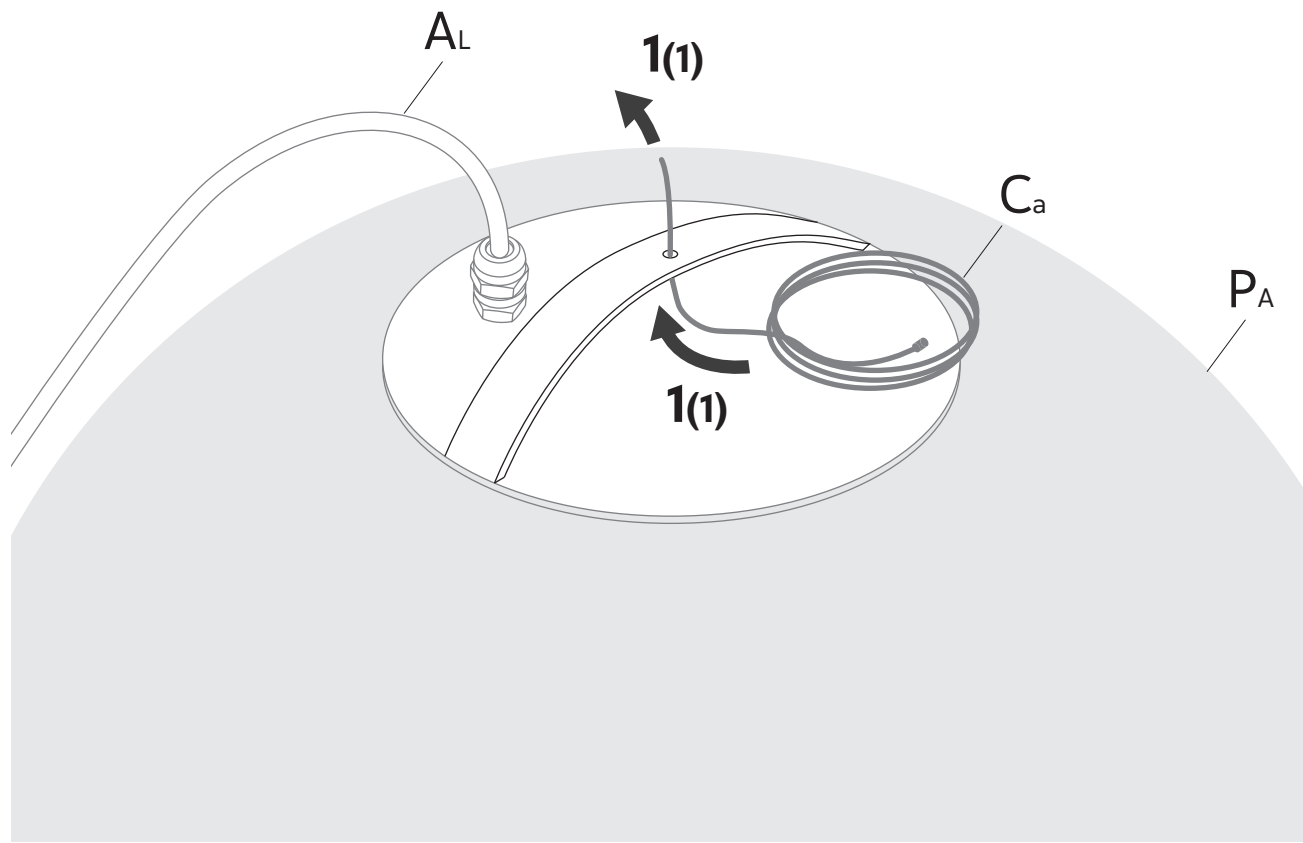
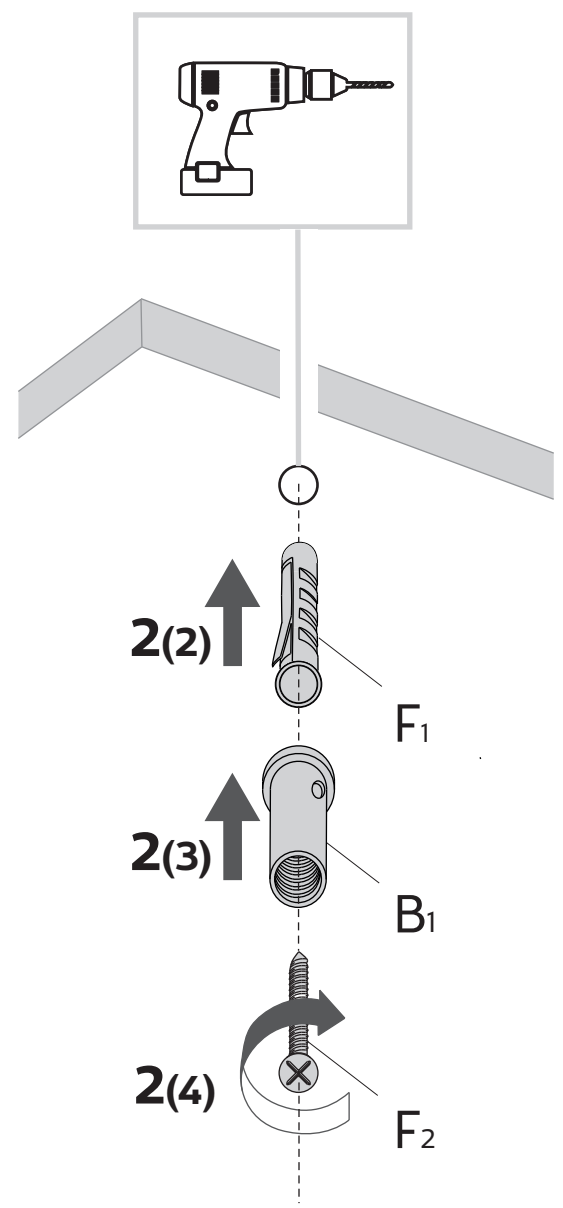
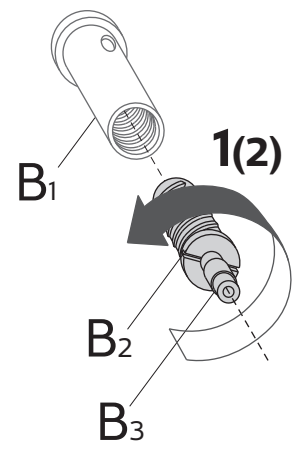
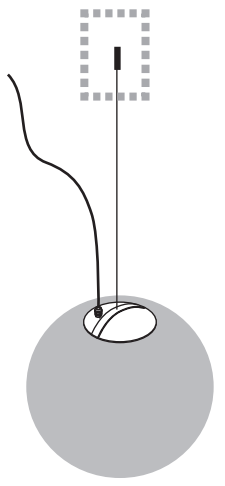

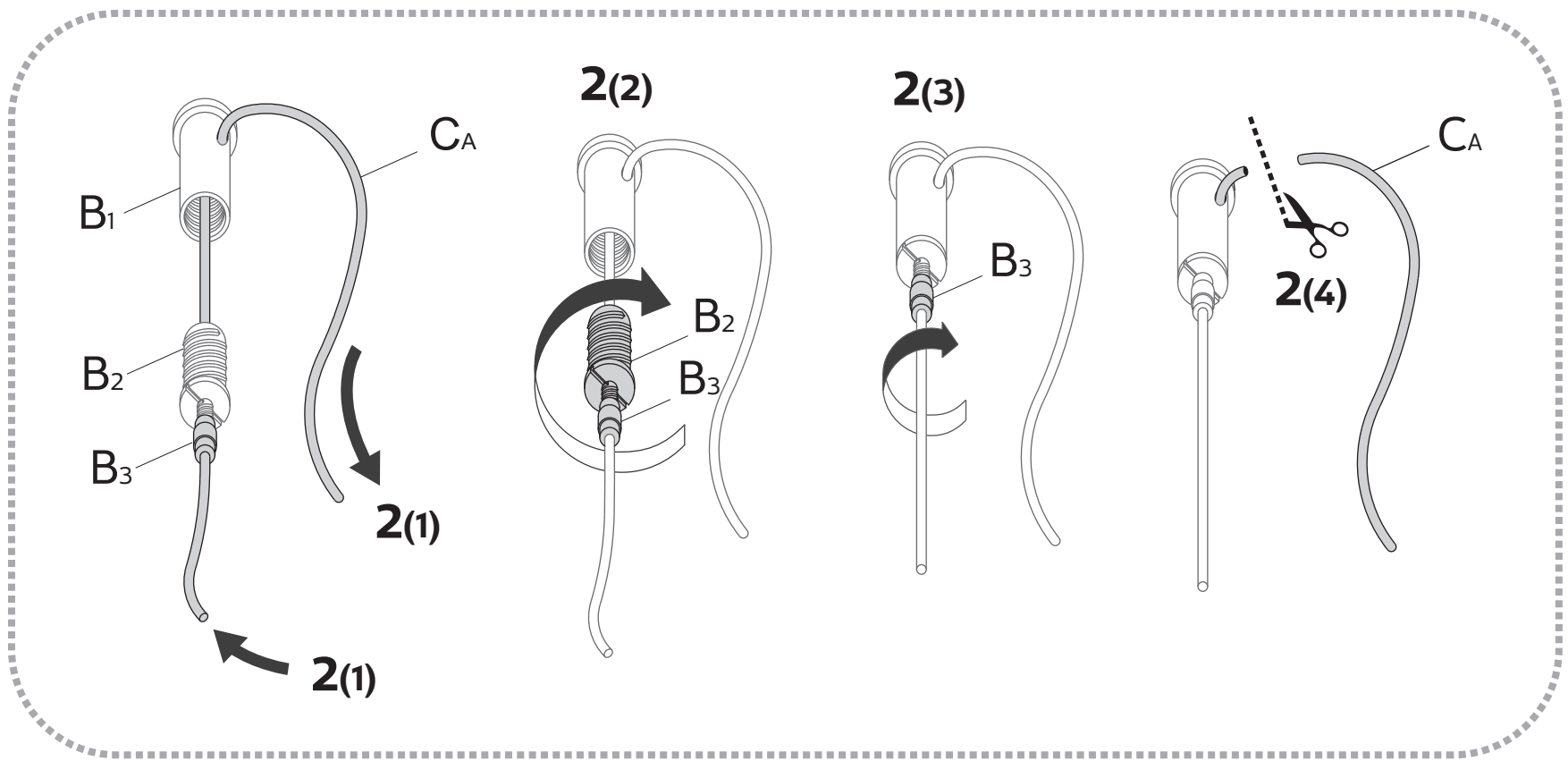
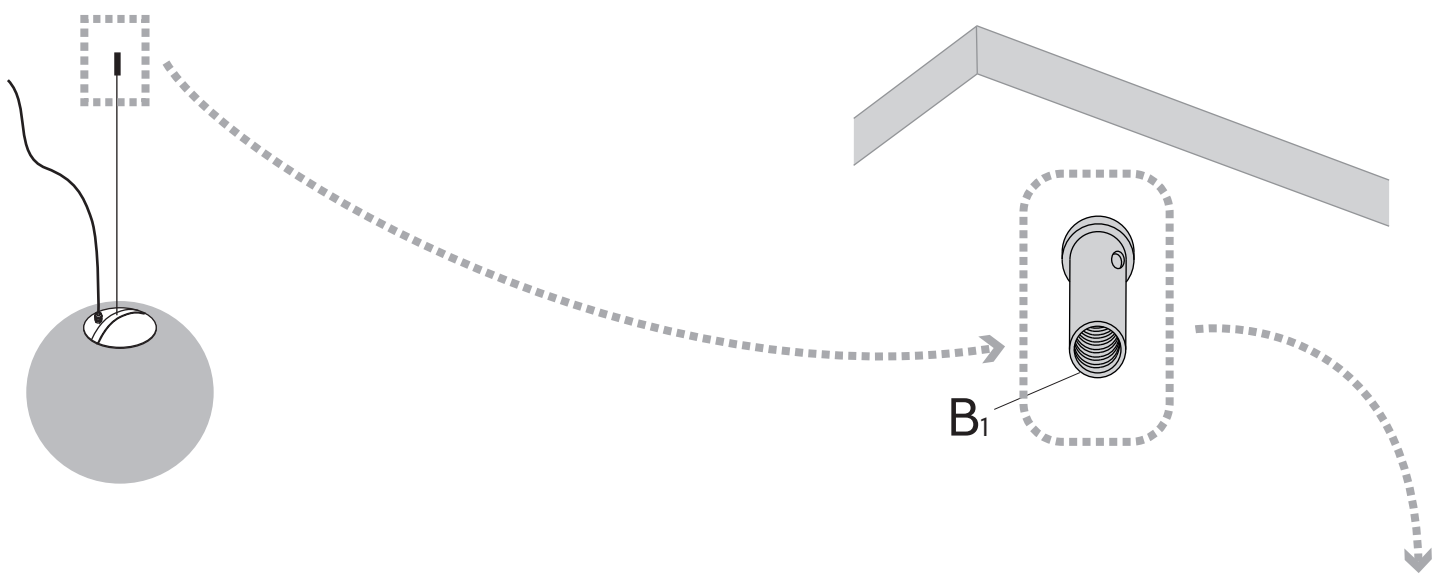

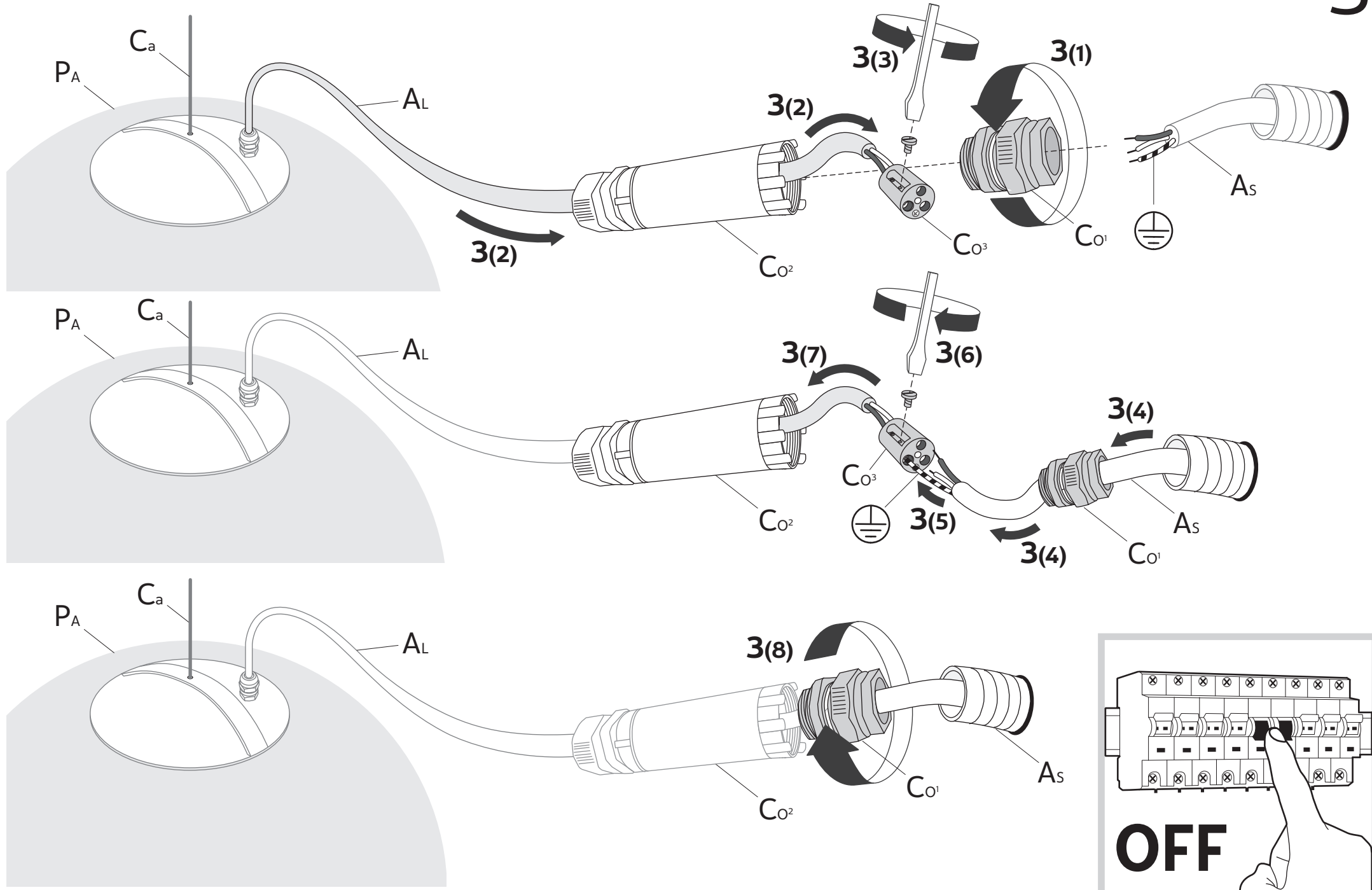

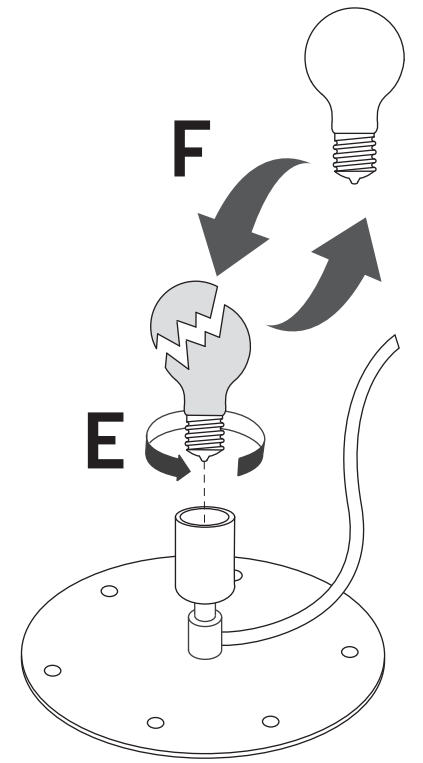
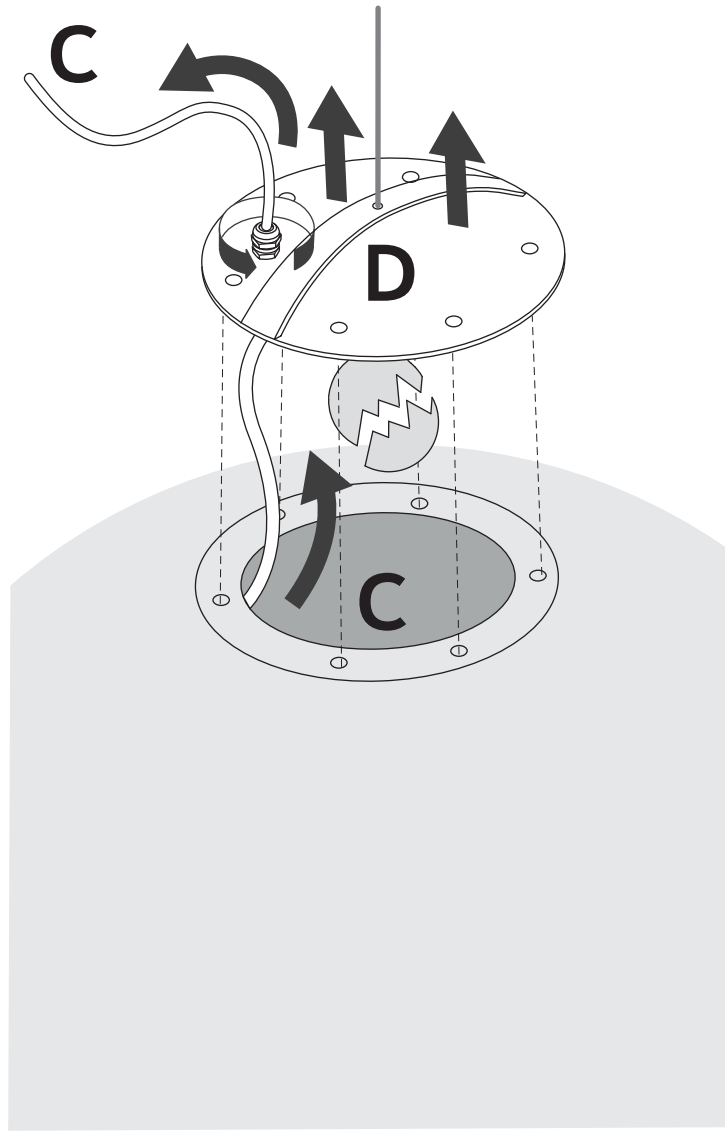
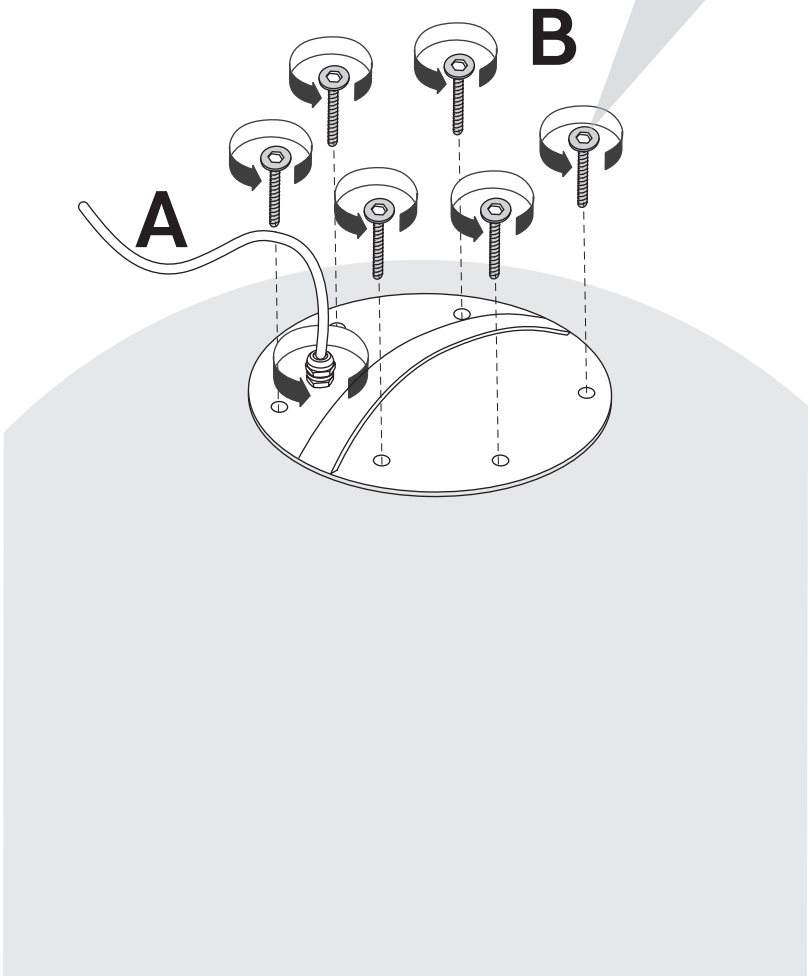
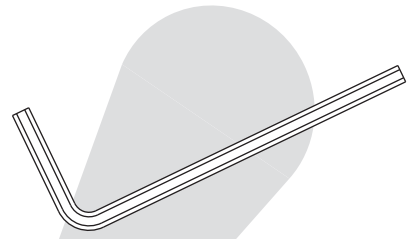
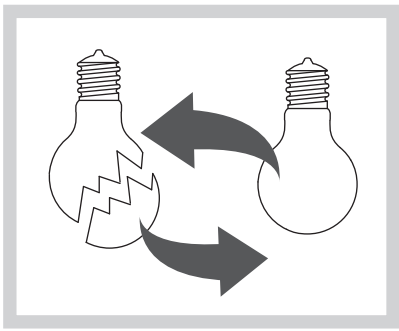

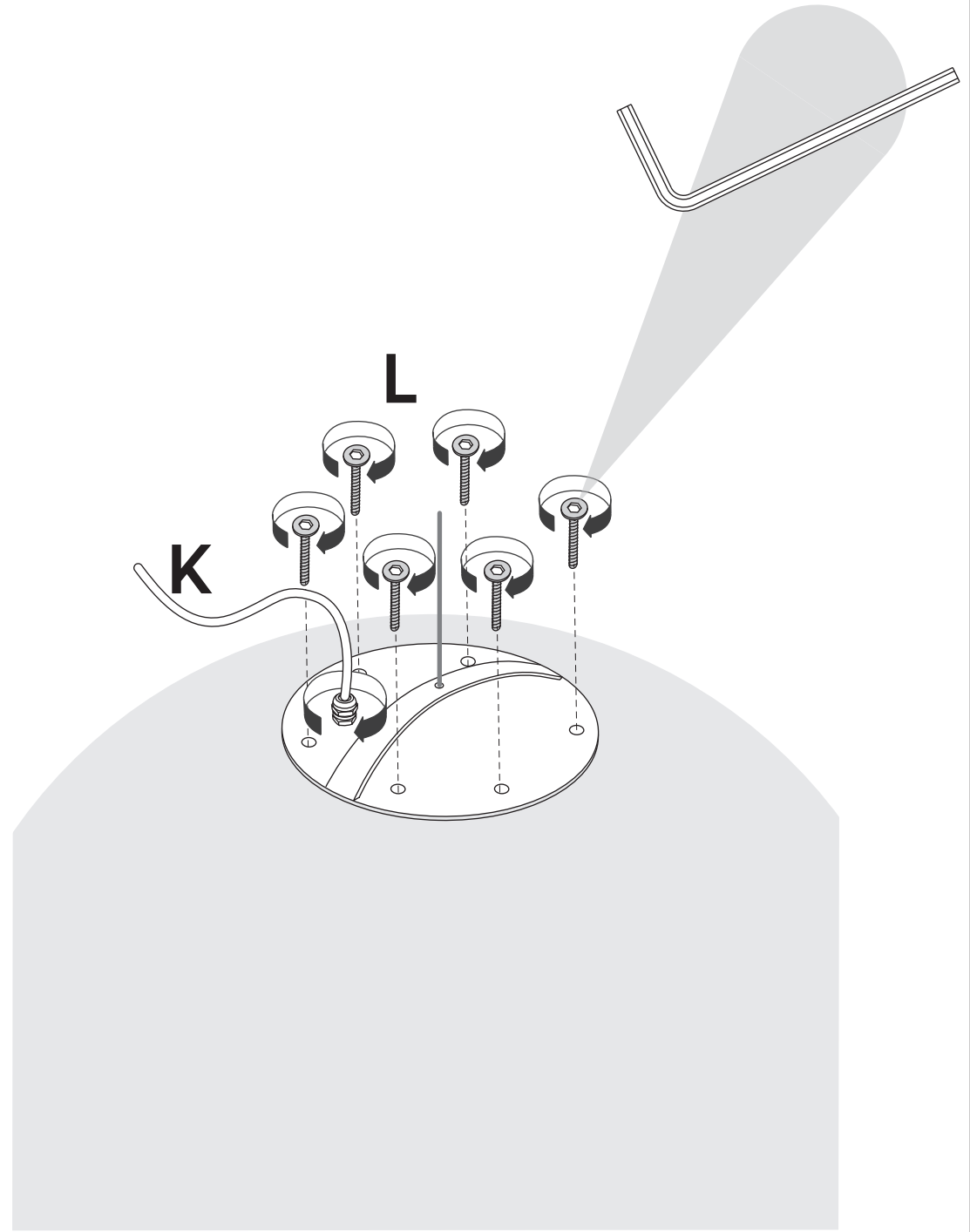
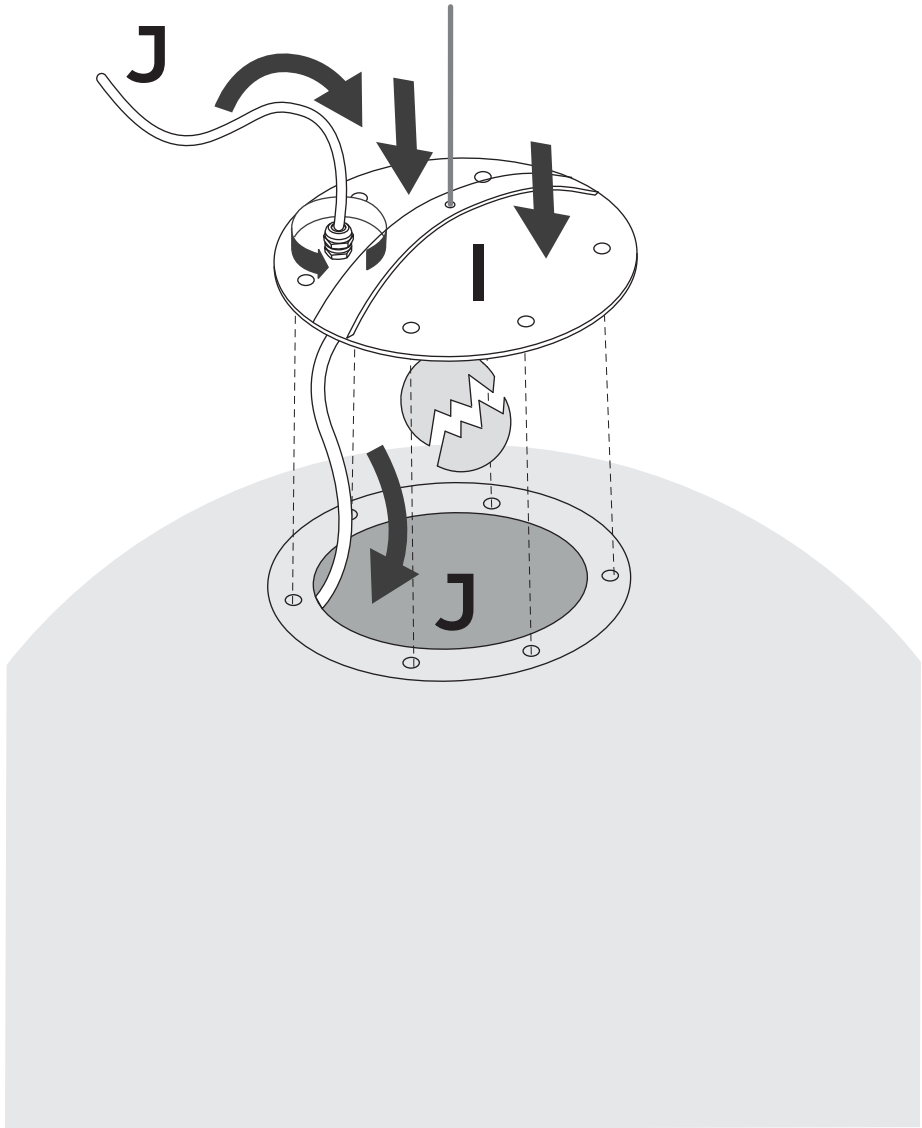
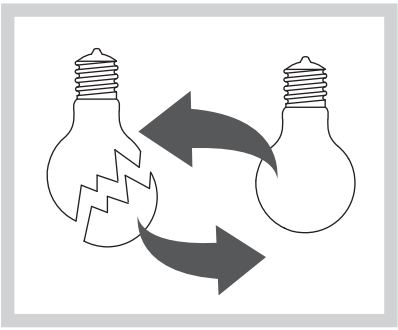

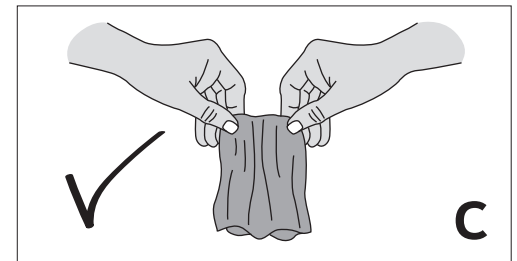
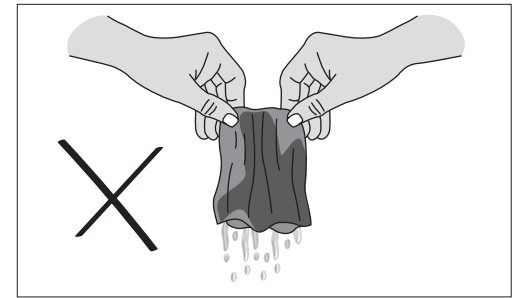
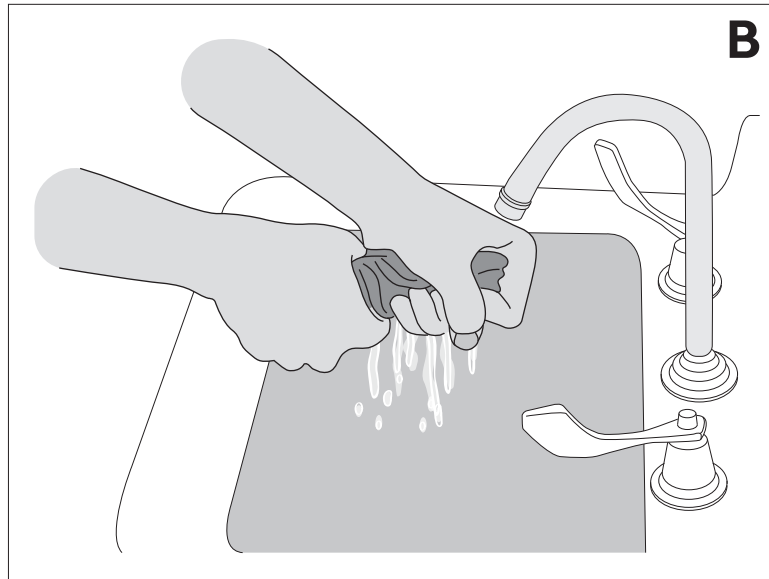
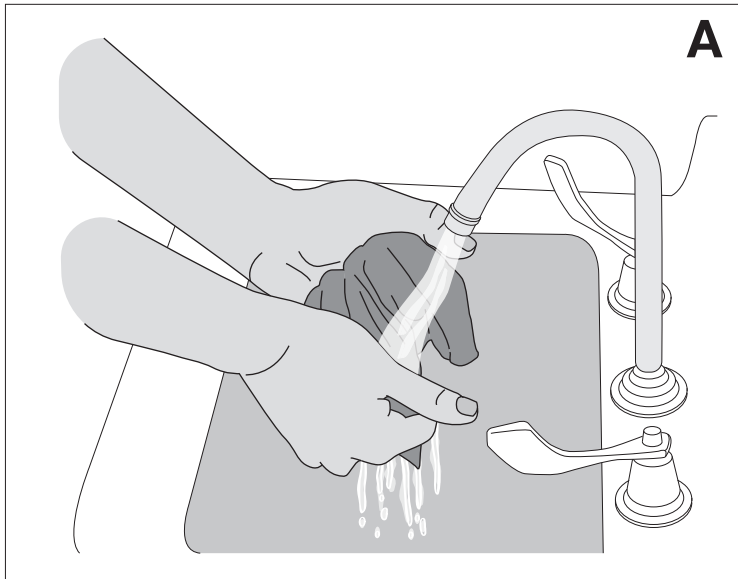

ULULÌ E ULULÀ

SE649GG-EXT

SE648PG-EXT

optional

SR026 1N INT

SE649GB-EXT

SE648PB-EXT

optional



SR026 2B INT

220-240 V.

max 1x105W - E27 (a)

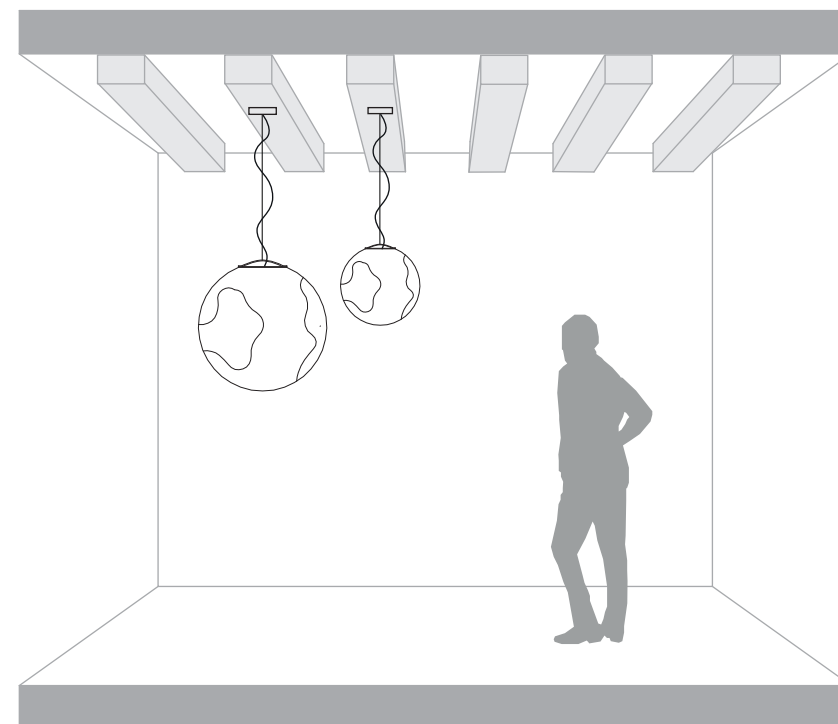
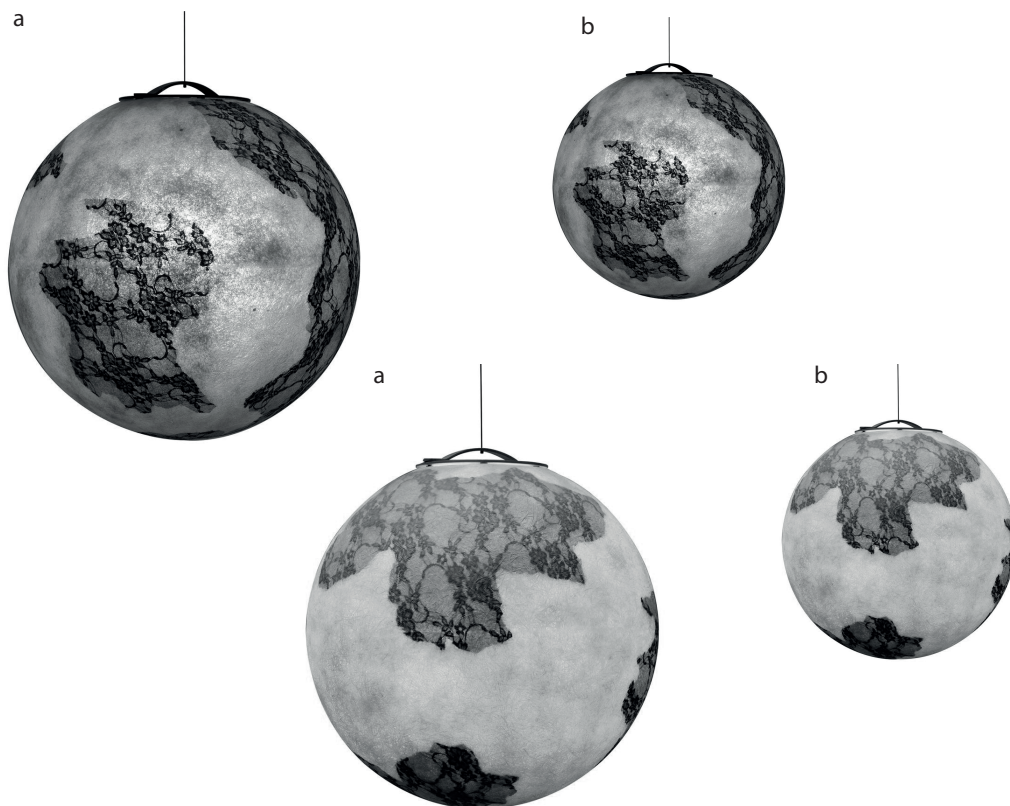
max 1x70W - E27 (b)

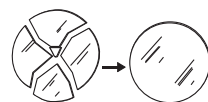

IP65   

Karman srl

Via A. Grandi, San Martino del piano, 61034 Fossombrone (PU), Italy - p.iva 02175640412 tel +39 0721 71 5042 r.a fax +39 0721 716640 - www.karmanitalia.it

C - 01

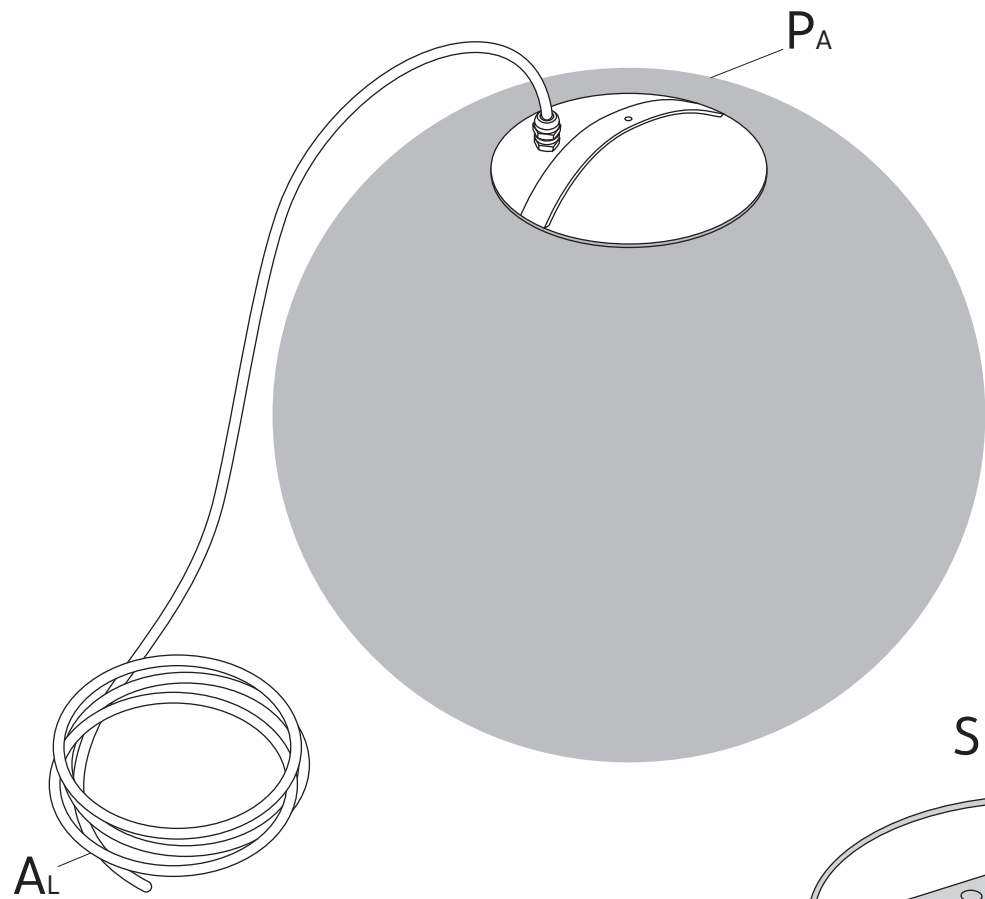

1x C_a

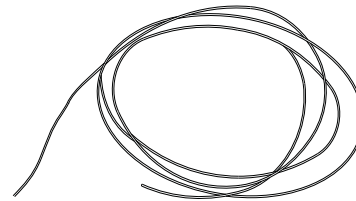

1x B_a

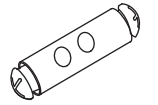

2x F

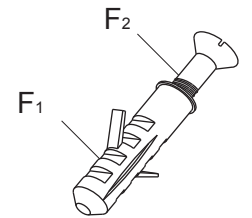

1x P

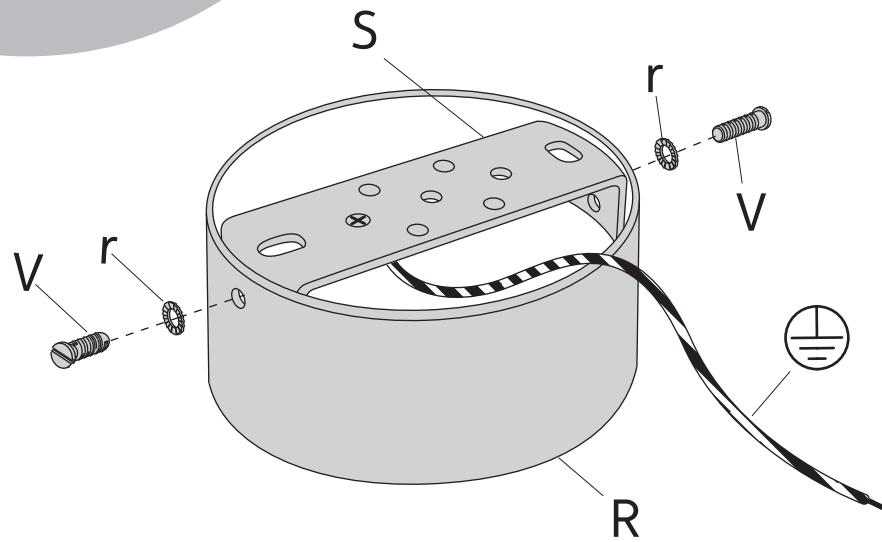
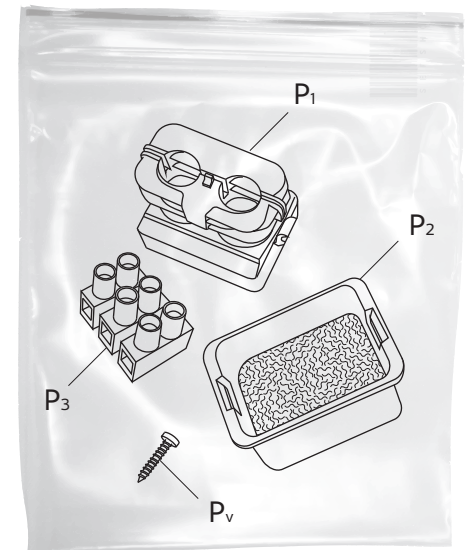

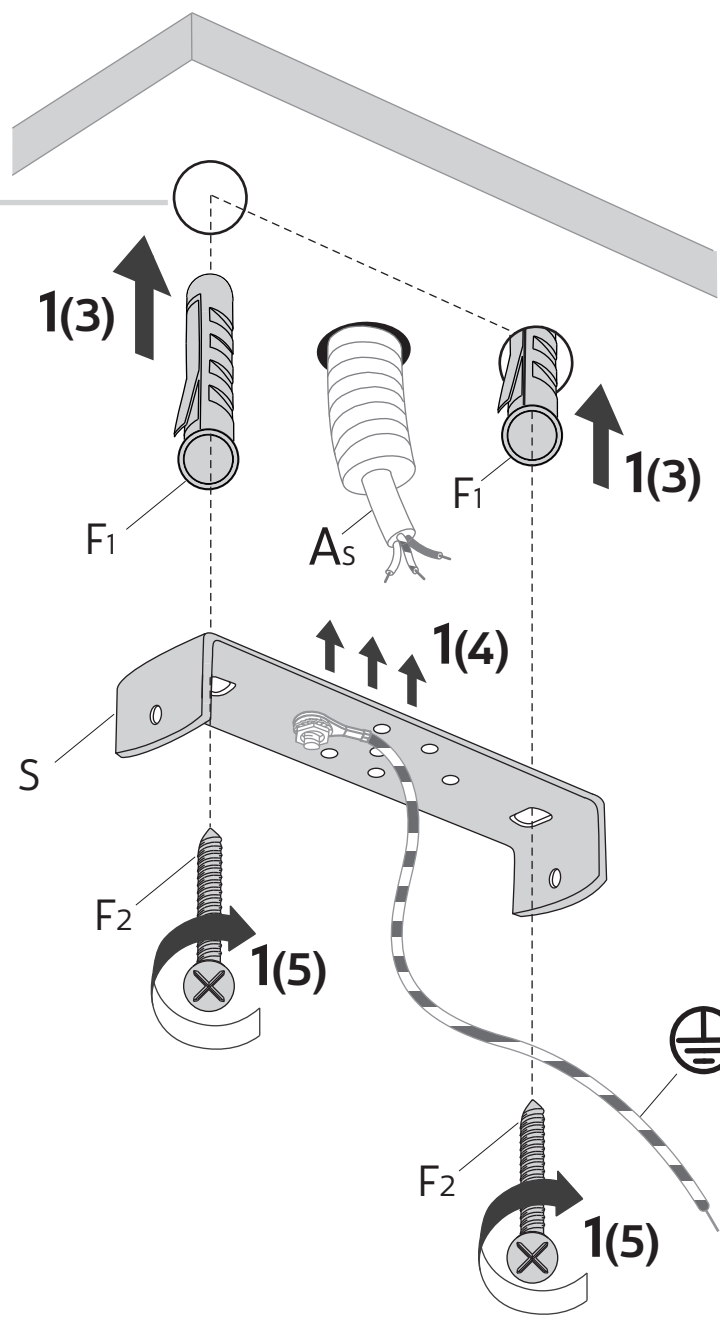
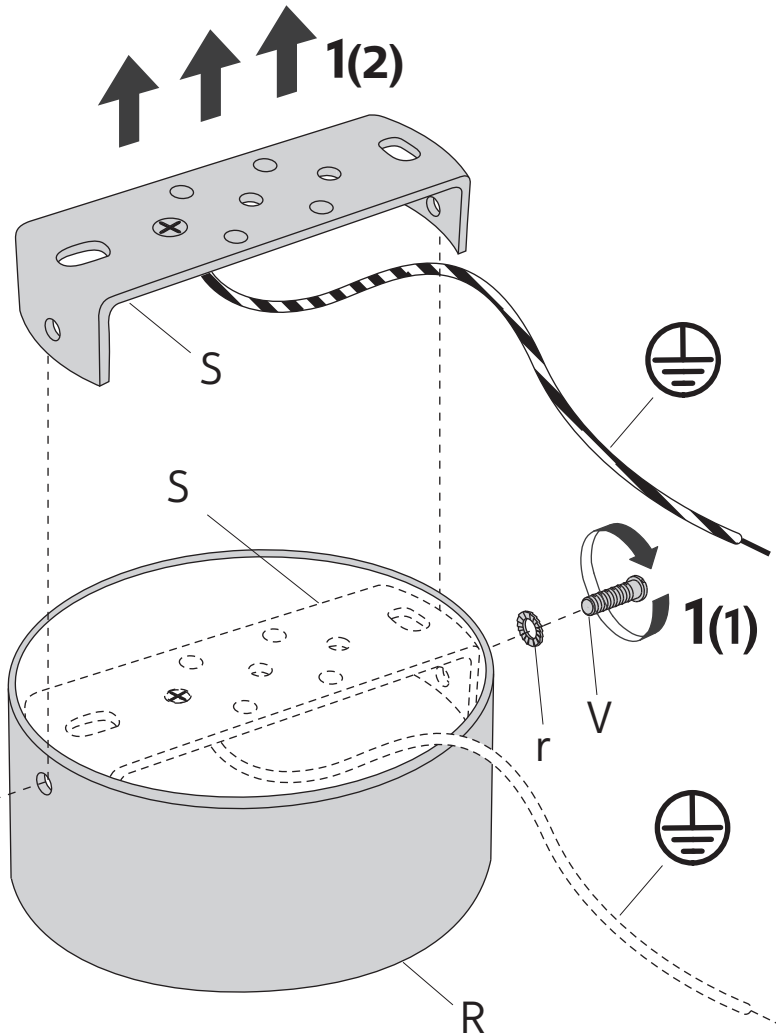
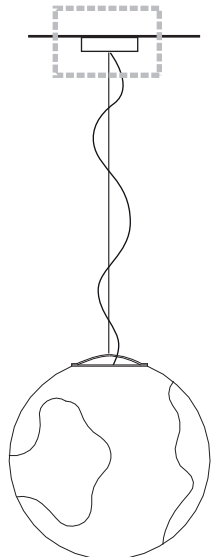
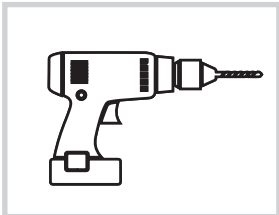
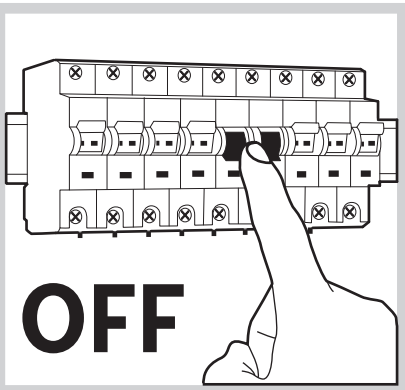

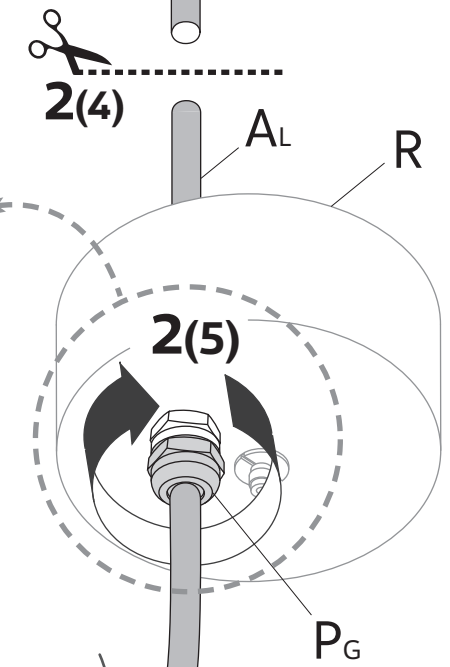
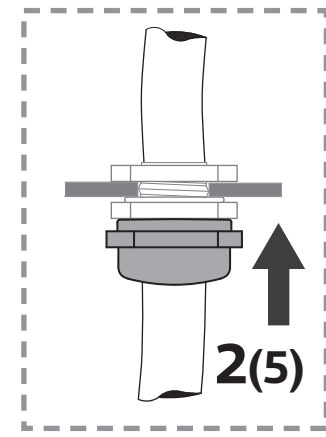
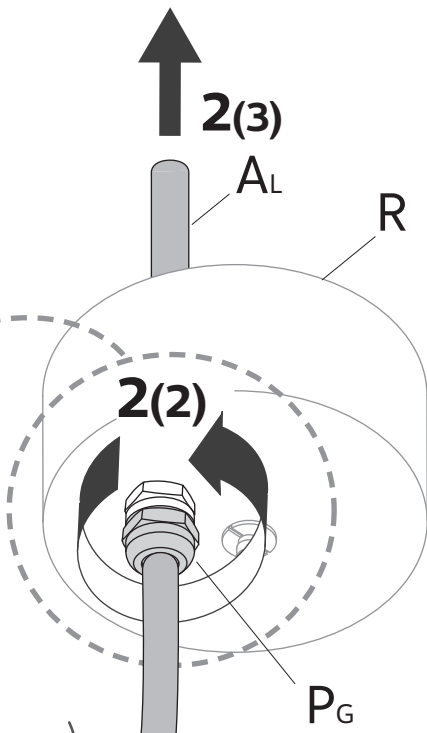
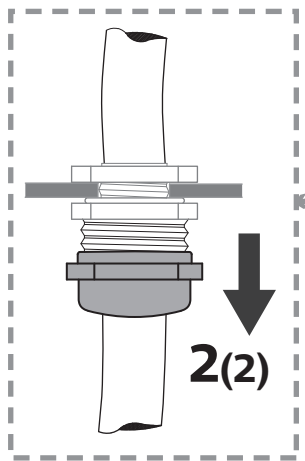
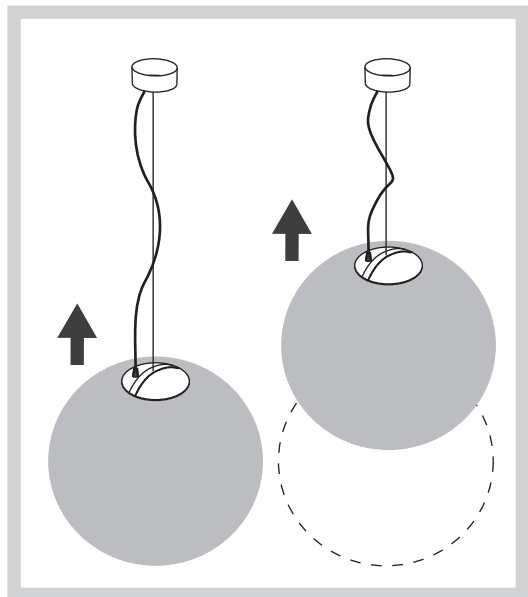

2

