

Included Components

- A. Blown Glass (QTY:24)
- B. Set Screws (QTY:48)
- C. Canopy
- D. Threaded Rod Assembly
- E. Top and Bottom Hemispheres Wired Separately
- F. Accent Rods
- G. Flat Cap
- H. Mounting Hardware Packet with Instructions
- I. Threaded Rod Instructions

Required Tools

- 1. Allen Key (provided)
- 2. Philips screw driver (not provided)
- 3. Wire cutters/strippers (not provided)
- 4. Measuring tape (not provided)

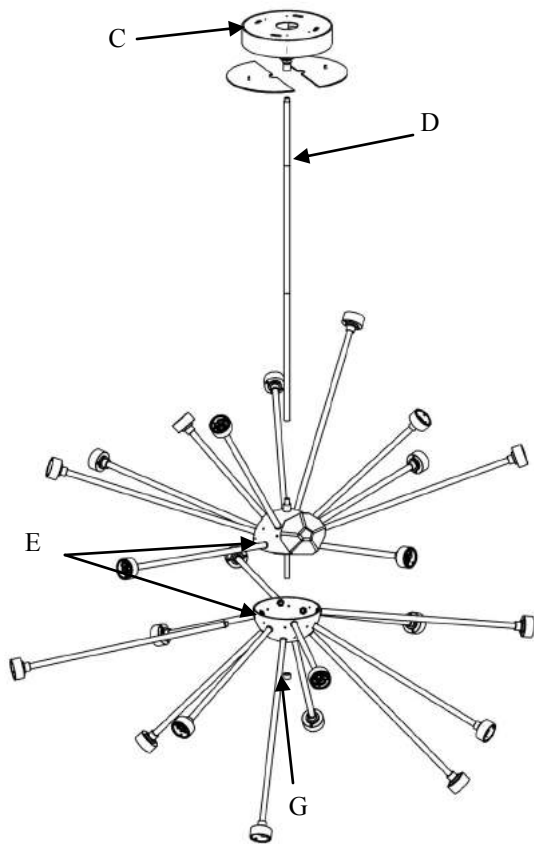

Assembly Instructions

Step 1: The top and bottom hemispheres should be packed separately. Carefully remove the hemispheres with the dangling arms and wiring from the packing. Attach the arms, without the glass, onto the two halves by pushing the protruding all thread on arms through the respective holes and securing them using hex nuts.

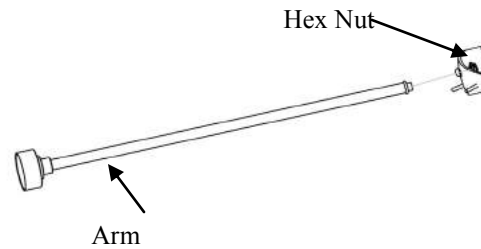

Step 2: Attach the two halves together using the flat cap. Rotate the lower half slightly to get the correct alignment. Ensure that the wires for the bottom hemisphere are also pushed through the coupler on the top.

Step 3: Using the provided **Threaded Rod Instructions**, assemble the threaded rod assembly with the desired OAH. Locktite must be used on the threaded rods before final

Step 4: Attach one end of the threaded rod assembly to the coupler mounted to the center sphere.

Step 5: Remove canopy cover plates and attach the threaded rod assembly to the canopy. Pushing the wires through the rods and into the canopy.

Step 6: Make DC wire connections from the fixture to each of the two drivers, **Black to Black and Red to Red**.

Step 7: Mount the canopy to the ceiling using the provided **Mounting Instructions**.

Step 8: Connect drivers to the AC source power. The Wires must be wired to the Driver, **Black to Black and White to White**.

NOTE: RED and BLACK wires are for DC power only.

Step 10: Re-install canopy cover plates.

Step 11: Attach accent rods to light by threading them into the 8-32 all thread. There is no particular placement order for the different sized accent rods.

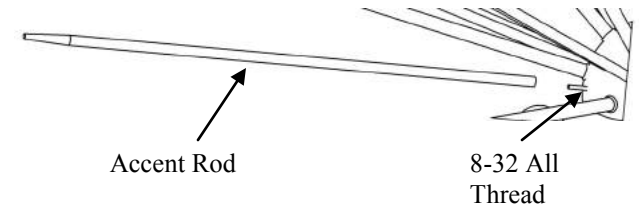

Step 12: Attach glass to the starburst arms by tightening the set screws to hold glass in place.

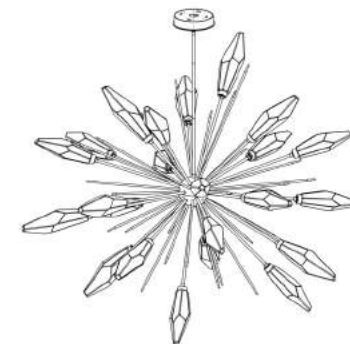
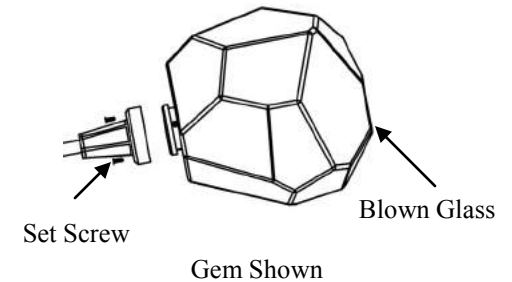

About Hammerton Studio

HAMMERTON STUDIO

In 2013, the Hammerton Studio brand was created to offer artisan-crafted, contemporary design solutions that are both versatile and accessible. Hammerton Studio fixtures add contemporary distinction to entries, great rooms and master suites, yet are cost-effective enough to use throughout any residential or commercial projects. Like all Hammerton fixtures, they are designed and fabricated in Salt Lake City, Utah using domestically sourced materials.

POWERFUL DESIGN

Since 1992, Hammerton has been known for extraordinary decorative lighting that is boldly designed, expertly rendered, perfectly proportioned and exquisitely detailed. Each fixture exudes a design aesthetic that is timeless and enduring, yet remarkably relevant.

UNCOMPROMISING CRAFTSMANSHIP

In addition to their exceptional metalworking and finishing expertise, Hammerton artisans share an aesthetic eye and a sculptural talent that define the difference between ordinary and extraordinary craftsmanship. Every fixture demonstrates its artisan's ability to elevate craft to an art form.

UNIQUE MATERIALS

Our heritage is in metal fabrication, but our passion is design. As a result—and unlike most of our peers—we work in a broad palette of materials: steel and aluminum, blown, kiln-fired and lampworked glass, acrylics, mica, stone, rawhide, woods and much more. Seamless integration of these capabilities is the “secret sauce” that drives our industry leadership as the premier U.S. based custom lighting manufacturer.

A REPUTATION REFLECTED BY OUR CLIENTS

Hammerton fixtures are as extraordinary as the clients who purchase them, including Forbes 400 members, Fortune 500 leaders, award-winning entertainers, fashion and interior designers, sports legends, and leading luxury hospitality brands.

Hammerton
217 Wright Brothers Drive
Salt Lake City, UT
84116

801-973-8095
info@hammerton.com
www.hammerton.com

Warranty

ONE YEAR LIMITED WARRANTY

Hammerton, Inc. (Hammerton) warrants the original owner that this product will be free of defects in material or workmanship for the period of one year from the date of original purchase from Hammerton, if (i) the allegedly defective product has not been abused, misused or improperly maintained and or repaired during the warranty period, (ii) the defect is not caused by water damage/flooding, fire, explosion, earthquakes or similar phenomenon, and (iii) the defect is not caused by improper installation (unless installed by Hammerton). In order to obtain warranty service, the user must first complete a warranty claims form. Hammerton will determine if the product will be inspected on site or returned to Hammerton. If after the inspection Hammerton finds that the product is defective as claimed, Hammerton will, at its option, repair or replace the product free of charge, or Hammerton may in its sole discretion, refund the purchase price. Hammerton warrants any replaced or repaired products for ninety days after shipment or through the end of the original warranty period, whichever is longer. All products or parts that are replaced become the property of Hammerton. No representative or employee of Hammerton is authorized to make any modification or addition to this limited warranty.

TO THE FULL EXTENT ALLOWED BY LAW, THE FOREGOING WARRANTY AND REMEDIES ARE EXCLUSIVE, AND HAMMERTON EXPRESSLY DISCLAIMS ALL OTHER WARRANTIES, EXPRESSED OR IMPLIED, INCLUDING WITHOUT LIMITATION THE IMPLIED WARRANTIES OF MERCHANTABILITY AND FITNESS FOR A PARTICULAR PURPOSE. TO THE FULL EXTENT ALLOWED BY LAW, HAMMERTON EXCLUDES AND DISCLAIMS LIABILITY, WHETHER BASED IN CONTRACT OR TORT (INCLUDING NEGLIGENCE FOR ANY CONSEQUENTIAL, INDIRECT INCIDENTAL OR SPECIAL DAMAGES OF ANY NATURE ARISING OUT OF THE SALE INSTALLATION, MAINTENANCE, USE OR FAILURE OF THIS PRODUCT, EVEN IF HAMMERTON HAS BEEN ADVISED OF THE POSSIBILITY OF SUCH DAMAGES IN ADVANCE, AND HAMMERTON LIMITS ITS LIABILITY TO REPLACEMENT, REPAIR OR REFUND OF THE PURCHASE PRICE PAID, AT HAMMERTON'S OPTION.) SOME STATES DO NOT ALLOW LIMITATIONS ON HOW LONG AN IMPLIED WARRANTY LASTS AND/OR DO NOT ALLOW THE EXCLUSION OR LIMITATION OF INCIDENTAL OR CONSEQUENTIAL DAMAGES, SO THE ABOVE LIMITATION ON IMPLIED WARRANTY AND INCIDENTAL OR CONSEQUENTIAL DAMAGES MAY NOT APPLY TO YOU. THIS WARRANTY GIVES YOU SPECIFIC LEGAL RIGHTS YOU MAY HAVE OTHER RIGHTS, WHICH VARY FROM STATE TO STATE

HAMMERTONSTUDIO™

Assembly Instructions

Large Scale Starburst
CHB0039-0M, CHB0039-0L
CHB0049-0C, CHB0049-0D
CHB0050-0C, CHB0050-0D

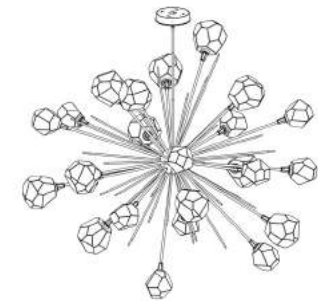

Gem
Starburst

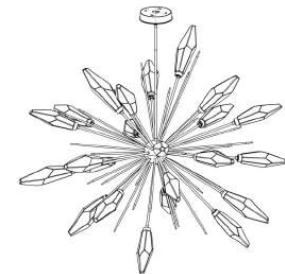

Aalto
Starburst

WARNING: FAILURE TO INSTALL THIS FIXTURE PROPERLY MAY RESULT IN SERIOUS PERSONAL INJURY OR DEATH AND PROPERTY DAMAGE.

It is recommended that this product be installed by a licensed electrician.

Rev 1
41-001-00070

Included Components

- A. 1/4" x 2"L Lags (4)
- B. Washers (4)
- C. Wire Nuts (3)

Required Tools

- 1. Philips Screw Driver (not included)
- 2. Drill (not included)
- 3. 3/16" Drill bit (not included)
- 4. Socket or Wrench (not included)

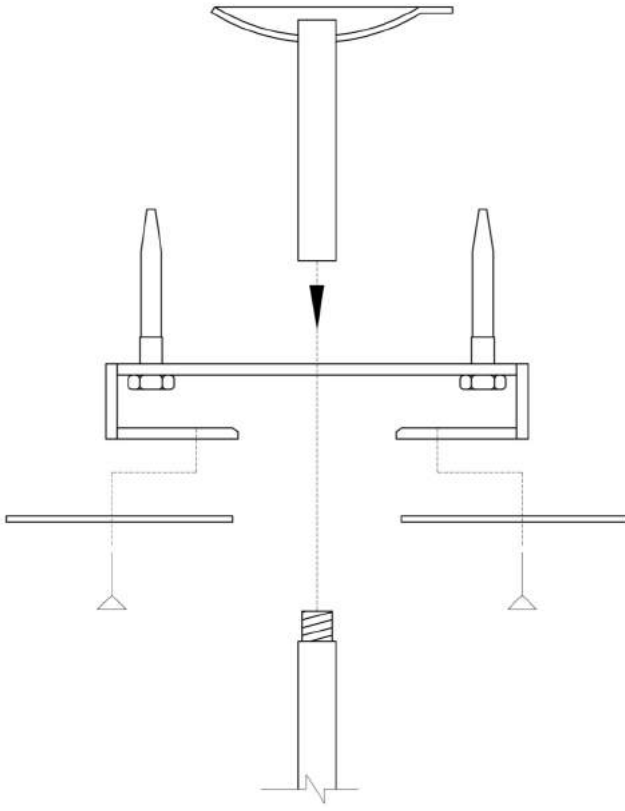

Example: Hang Straight Canopy
with $\text{Ø}5/8$ " Threaded Stem

Mounting Instructions

Step 1: Mark mounting hole locations using the canopy as a template.

Step 2: Drill pilot holes for the 1/4" lags using the 3/16" drill bit.

Step 3: Install canopy using the provided lags. Canopy must be installed with swivel in place (where applicable).

Step 4: Hang the fixture following the Assembly Instructions. Make wire connections. Install cover plates.

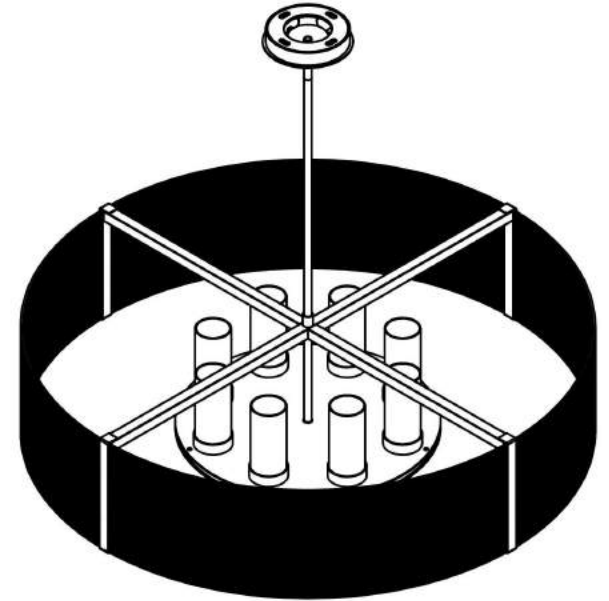

Example: CHB0020-48
Rod Suspended Fixture

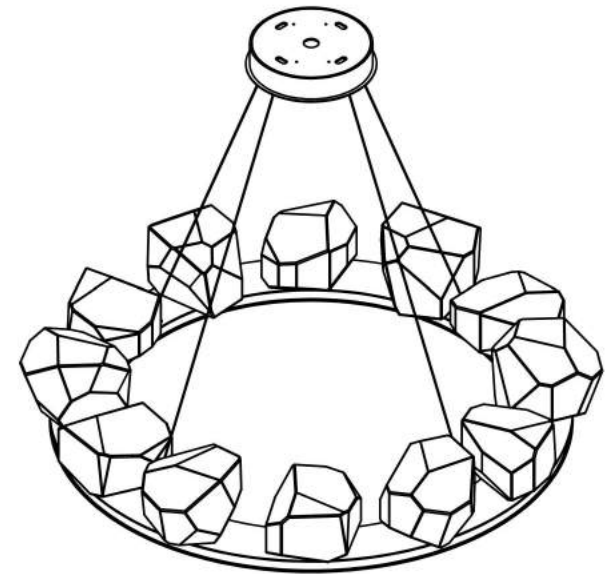

Example: CHB0039-0C
Cable Suspended Fixture

About Hammerton Studio

HAMMERTON STUDIO

In 2013, the Hammerton Studio brand was created to offer artisan-crafted, contemporary design solutions that are both versatile and accessible. Hammerton Studio fixtures add contemporary distinction to entries, great rooms and master suites, yet are cost-effective enough to use throughout any residential or commercial projects. Like all Hammerton fixtures, they are designed and fabricated in Salt Lake City, Utah using domestically sourced materials.

POWERFUL DESIGN

Since 1992, Hammerton has been known for extraordinary decorative lighting that is boldly designed, expertly rendered, perfectly proportioned and exquisitely detailed. Each fixture exudes a design aesthetic that is timeless and enduring, yet remarkably relevant.

UNCOMPROMISING CRAFTSMANSHIP

In addition to their exceptional metalworking and finishing expertise, Hammerton artisans share an aesthetic eye and a sculptural talent that define the difference between ordinary and extraordinary craftsmanship. Every fixture demonstrates its artisan's ability to elevate craft to an art form.

UNIQUE MATERIALS

Hammerton's recent acquisition of the Lightspann brand has added unparalleled strength in all types of artisan glass, including hand-blown, slumped, fused, and lampworked glass. The combination of Hammerton's traditional metalworking and Lightspann glass allows steel, woven mesh, fabric and glass to be combined in a manner which cannot be duplicated

A REPUTATION REFLECTED BY OUR CLIENTS

Hammerton fixtures are as extraordinary as the clients who purchase them, including Forbes 400 members, Fortune 500 leaders, award-winning entertainers, fashion and interior designers, sports legends, and leading luxury hospitality brands.

Hammerton
217 Wright Brothers Drive
Salt Lake City, UT
84116

801-973-8095
info@hammerton.com
www.hammerton.com

Warranty

ONE YEAR LIMITED WARRANTY

Hammerton, Inc. (Hammerton) warrants the original owner that this product will be free of defects in material or workmanship for the period of one year from the date of original purchase from Hammerton, if (i) the allegedly defective product has not been abused, misused or improperly maintained and or repaired during the warranty period, (ii) the defect is not caused by water damage/flooding, fire, explosion, earthquakes or similar phenomenon, and (iii) the defect is not caused by improper installation (unless installed by Hammerton). In order to obtain warranty service, the user must first complete a warranty claims form. Hammerton will determine if the product will be inspected on site or returned to Hammerton. If after the inspection Hammerton finds that the product is defective as claimed, Hammerton will, at its option, repair or replace the product free of charge, or Hammerton may in its sole discretion, refund the purchase price. Hammerton warrants any replaced or repaired products for ninety days after shipment or through the end of the original warranty period, whichever is longer. All products or parts that are replaced become the property of Hammerton. No representative or employee of Hammerton is authorized to make any modification or addition to this limited warranty.

TO THE FULL EXTENT ALLOWED BY LAW, THE FOREGOING WARRANTY AND REMEDIES ARE EXCLUSIVE, AND HAMMERTON EXPRESSLY DISCLAIMS ALL OTHER WARRANTIES, EXPRESSED OR IMPLIED, INCLUDING WITHOUT LIMITATION THE IMPLIED WARRANTIES OF MERCHANTABILITY AND FITNESS FOR A PARTICULAR PURPOSE. TO THE FULL EXTENT ALLOWED BY LAW, HAMMERTON EXCLUDES AND DISCLAIMS LIABILITY, WHETHER BASED IN CONTRACT OR TORT (INCLUDING NEGLIGENCE FOR ANY CONSEQUENTIAL, INDIRECT INCIDENTAL OR SPECIAL DAMAGES OF ANY NATURE ARISING OUT OF THE SALE INSTALLATION, MAINTENANCE, USE OR FAILURE OF THIS PRODUCT, EVEN IF HAMMERTON HAS BEEN ADVISED OF THE POSSIBILITY OF SUCH DAMAGES IN ADVANCE, AND HAMMERTON LIMITS ITS LIABILITY TO REPLACEMENT, REPAIR OR REFUND OF THE PURCHASE PRICE PAID, AT HAMMERTON'S OPTION.) SOME STATES DO NOT ALLOW LIMITATIONS ON HOW LONG AN IMPLIED WARRANTY LASTS AND/OR DO NOT ALLOW THE EXCLUSION OR LIMITATION OF INCIDENTAL OR CONSEQUENTIAL DAMAGES, SO THE ABOVE LIMITATION ON IMPLIED WARRANTY AND INCIDENTAL OR CONSEQUENTIAL DAMAGES MAY NOT APPLY TO YOU. THIS WARRANTY GIVES YOU SPECIFIC LEGAL RIGHTS YOU MAY HAVE OTHER RIGHTS, WHICH VARY FROM STATE TO STATE

HAMMERTONSTUDIO®

Mounting Instructions

Packets S & Z

WARNING: FAILURE TO INSTALL THIS FIXTURE PROPERLY MAY RESULT IN SERIOUS PERSONAL INJURY OR DEATH AND PROPERTY DAMAGE.

It is recommended that this product be installed by a licensed electrician.