

Collection: Aalto

Product #: IDB0049-07

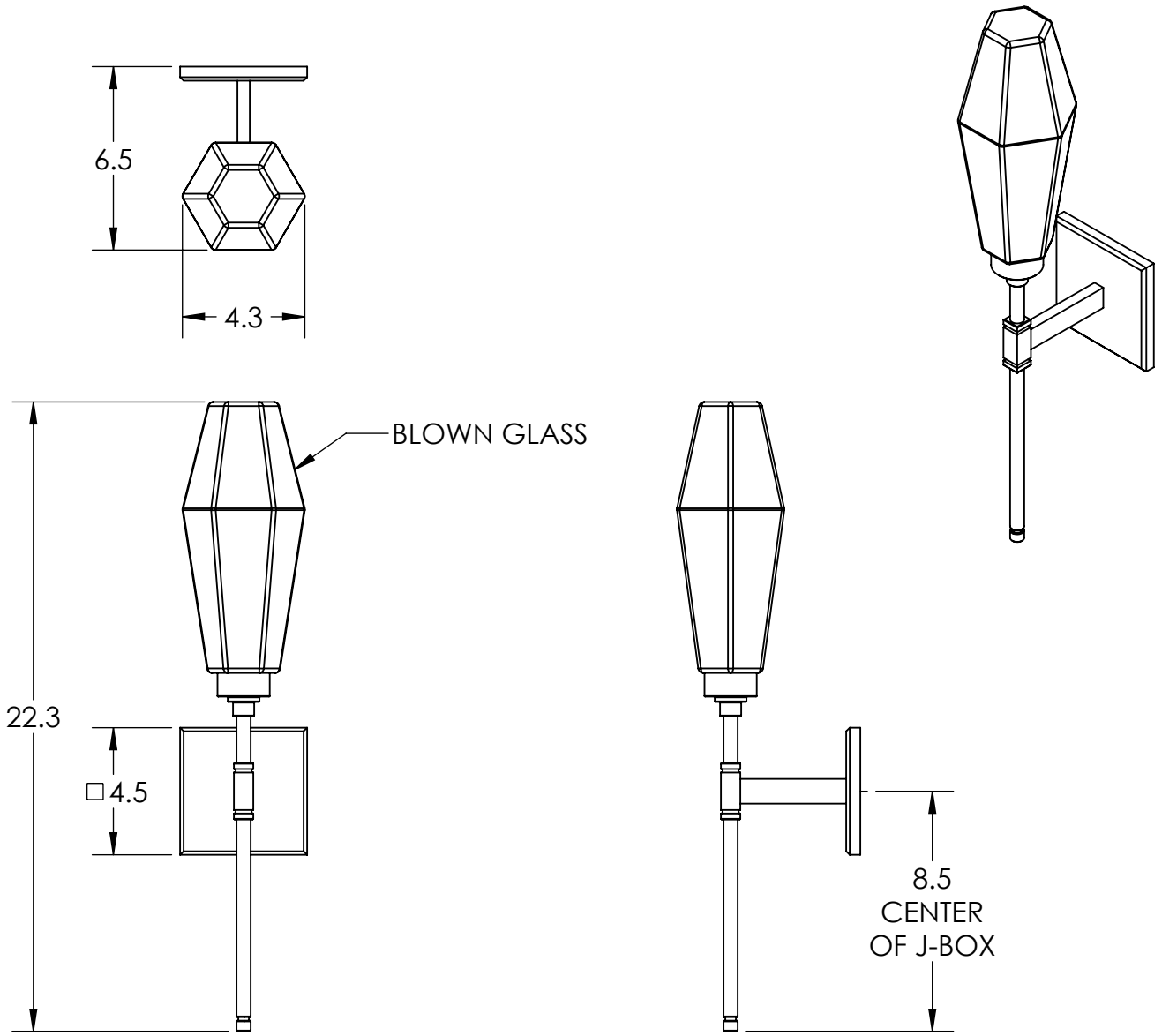

****NOTE****
 DRIVER TO BE INSTALLED IN JUNCTION BOX.
 MINIMUM SIZE J-BOX REQUIRED IS
 4" L X 4" W X 1.5" D

Visit hammertonstudio.com for product options and specifications.

10/17/2017 (A)

Mounting Packet: U	Weight(lbs.): 4	Electrical Type: LED	CCT: 2700 K
UL Location: DRY	Elec. Qty: 1	Wattage: 5.2	Voltage: 120
Finish: SEE WEB SITE FOR OPTIONS	Source Lumens: Up: 340	Down: N/A	
Top Diffuser: CLOSED GLASS	Dimmable: Forward/Reverse Phase or 0-10V To 1%		
Bottom Diffuser: CLOSED METAL	CRI: 93+	Power Factor: >0.9	
All fixtures created by Hammerton are handcrafted by artisans. Dimensions may vary up to 7/8".			
© Copyright 2017. All rights in design, detail or invention of this drawing are reserved as the property of Hammerton. Any imitation or adaptation without written consent is strictly prohibited.			
Hammerton Inc. 217 Wright Brothers Dr. Salt Lake City, UT 84116 (801)973-8095			

Mounting Detail

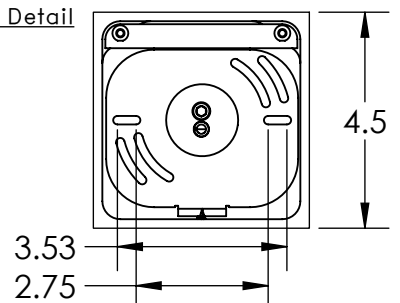

MOUNTS DIRECTLY TO J-BOX