



CARE INSTRUCTIONS

Wipe the parts with a damp cloth soaked in warm water and a bit of mild detergent. Use only soft cloth for wiping and polishing, never sponges or steel wool. Do not use abrasive household cleaners. Do not use acidic or alkaline cleaning materials, glass cleaner or household ammonia.

TROUBLESHOOTING

If lamp does not light, turn off the power. Check the bulb for a broken filament. Replace bulb if necessary, then turn it on. If the lamp still does not light, please contact customer service at the local dealer.

TECHNICAL INFORMATION

Recommended light source :

E26 Tubular (type) T30 or T9 Max length 10 inches, max 60W, 120V.

Turn power off when changing light bulb. Isolation class II. The lamp is not approved for outdoor use or use in damp/wet rooms (IP20)

CAUTION: TO REDUCE THE RISK OF FIRE, Do not exceed recommended wattage.
CAUTION! IMPORTANT: LAMP MUST BE INSTALLED BY A QUALIFIED ELECTRICIAN!

SAFETY INSTRUCTIONS

SAFETY INSTRUCTIONS PERTAINING TO RISK OF FIRE, ELECTRIC SHOCK, OR PERSONAL INJURY! WARNING: Lighted bulb gets HOT! Do not touch while on.
CAUTION: Keep lamp away from curtains, bedding linens, and any other flammable materials. Do not look directly at lighted bulb. Turn off/unplug and allow lamp to cool before replacing bulb, cleaning or other maintenance.



For enquiries contact GUBI A/S - CVR: 17940384
Orientkaj 18-20. 2150 Nordhavn. Copenhagen, Denmark
T +45 69 15 60 60 – salessupport@gubi.dk
GUBI.COM

51-20-031-04 Assembly Instructions Satellite Pendant US.

GUBI

ASSEMBLY INSTRUCTIONS

for

SATELLITE PENDANT

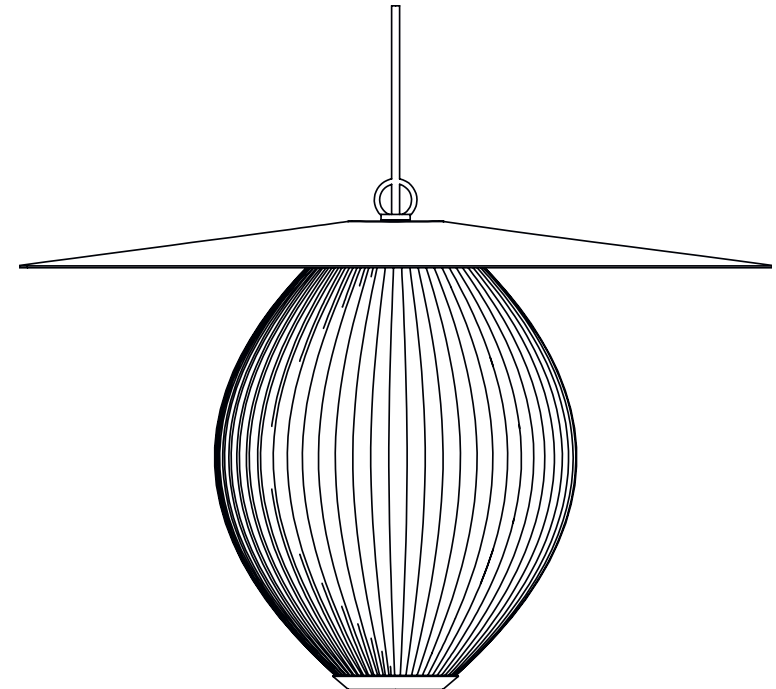

GUBI

ASSEMBLY INSTRUCTION

CONTENTS

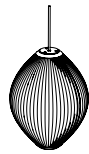

x1

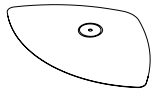

x1



x1



x1



x1



x1



x1



x1

1.

Put the light bulb in the socket. Place on top of the lantern.

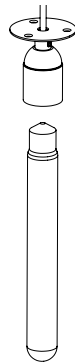

2.

Screw the wire set into the lantern and place the large rubber disk on top.

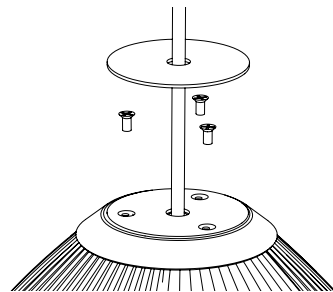

3.

Put the top hat on the lantern and screw the top hanger with the rubber disc through the hat and into the lantern.

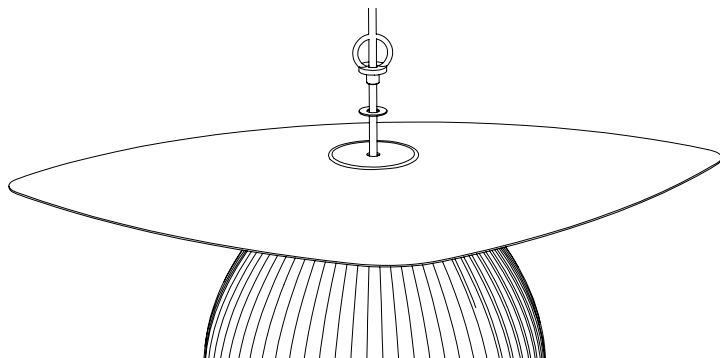

4.

Mount lamp to the ceiling using the hook.

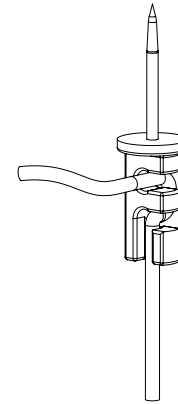

5.

Connect the lamp wires to the supply wires.

- Open connection box pushing the pins white pulling the lid.
- Connect mains wire and lamp wire in the screw terminal.
- Close connection box and place inside the canopy.

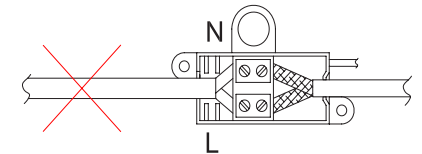
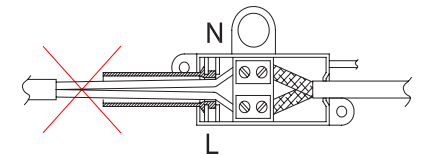
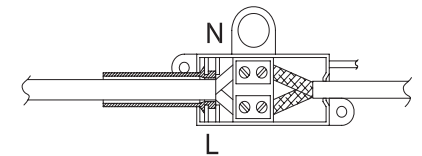
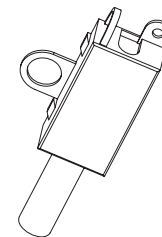

6.

- If the external flexible cable or cord of this luminaire is damaged, it shall be exclusively replaced by the manufacturer or his service agent or a similar qualified person in order to avoid a hazard.
- Only to be installed outside arm's reach.