

INSTALLATION INSTRUCTIONS

Item#P1911-084/66A-L (New.2022/04/13)

READ AND SAVE THESE INSTRUCTIONS

WARNING! SHUT POWER OFF AT FUSE OR CIRCUIT BREAKER.
AVERTISSEMENT! COUPER LE COURANT AU NIVEAU DES FUSIBLES OU DU DISJONCTEUR.

PREPARATION (Fig.1)

1. Shut off power at the fuse box or circuit breaker box and remove the old fixture including the mounting hardware.
2. Carefully unpack your new fixture and lay out all the parts in a clean area. Take care not to misplace any small parts necessary for installation.
3. Remove mounting plate (C) from ceiling canopy (E). Secure mounting plate (C) to outlet box (A) (Not included) with the mounting screws (D). Tighten until snug. Make sure the side of mounting plate (C) marked "GND" must face out.
4. Press the wire restraint (G) on ceiling canopy (E) to adjust cable to desired height by pulling and pushing the cable.

WIRES CONNECTIONS (Fig.2)

5. Pull power supply wires out from outlet box (A). Connect black supply wire to black fixture wire using wire nuts (B). Connect white supply wire to white fixture wire using wire nuts (B). Connect fixture ground wire and supply ground wire together using wire nuts (B). If your outlet box does not have a ground wire, connect the fixture's ground wire directly to the mounting plate (C) using the green screw provided. Secure all wire nuts with electrical tape.

COMPLETING THE INSTALLATION (Fig.1)

6. Assembling fixture body to outlet box (A). Line up holes on ceiling canopy (E) and mounting holes on mounting plate (C). Secure with lock screws (F). Tighten until snug.

Replacing LED driver (Fig. 3)

The LED driver can be replaced by a qualified electrician without cutting of wire and without damage to any decorative element to which the fixture is attached. See installation steps for more details (Fig.3)

- a. Shut off the power.
- b. Remove lock screws (F) on canopy (E) from mounting plate (C) with screw driver (Not included). Disconnect the fixture wires from the outlet box (A). (Fig.1)
- c. Loosen screws (CC) and carefully remove led driver (BB) from ceiling canopy (E).
- d. Un-twist wire nuts (DD) to loosen red and yellow wires.
- e. Reverse steps a-d for installing new LED driver

Your installation is now complete. Return power to outlet box and test the fixture.

Note: Illustration (Fig.1) on this manual is for installation purposes only. It may or may not be identical to the fixture purchased.

Dimmable with ELV and/or LED compatible wall dimmer switches.

Fig. 1

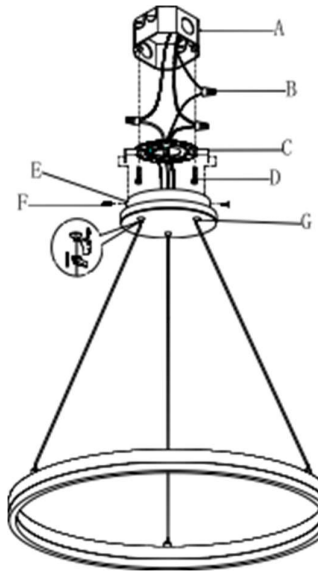

Set#A-020-145

-Mounting Plate

-Ground Screw

-Mounting Screw*2

Fig. 2

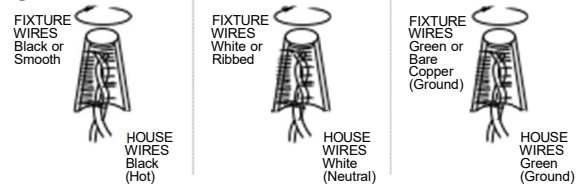
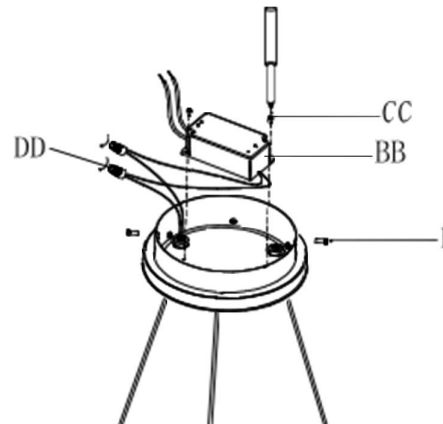

Fig. 3



LA-3188E



american
lighting
association