

INSTALLATION INSTRUCTIONS

Item#P1894-XXX-L (New. 2021/10/19)

READ AND SAVE THESE INSTRUCTIONS

WARNING! SHUT POWER OFF AT FUSE OR CIRCUIT BREAKER.

AVERTISSEMENT! COUPER LE COURANT AU NIVEAU DES FUSIBLES OU DU DISJONCTEUR.

MOUNTING THE FIXTURE (Fig.1)

1. Shut off power at the fuse box or circuit breaker box and remove the old fixture including the mounting hardware.
2. Carefully unpack your new fixture and lay out all the parts in a clear area. Take care not to misplace any small parts necessary for installation.
3. Loosen screws (C) to remove mounting plate (A) from back plate (D). Position mounting plate (A) on wall and mark location of two drywall anchors (F). Pre-drill holes for drywall anchors (F). Insert drywall anchors (F) into wall.
4. Attach mounting plate (A) to junction box (not included) using mounting screws (B). The side of the mounting plate (A) marked "GND" must face out.
5. Screw wood screws (H) through holes into drywall anchor (F) to secure mounting plate (A) as shown in Fig.1.

CONNECTING THE WIRES (Fig. 2)

6. Connect the electrical wires as shown in Fig. 2, making sure that all wire connectors are secured. If your junction box has a ground wire (green or bare copper), connect the fixture's ground wire to it. Otherwise, connect the fixture's ground wire directly to the mounting plate (A) using the green screw provided.
7. Tuck wire connectors neatly inside junction box.

FINISHING THE INSTALLATION (Fig.1)

8. Place back plate (D) over mounting plate (A) and secure with screws (C).
9. Align glass shade (E) onto back plate (D) and secure with plastic washers (K) and screws (C).
10. Place decorative frame (G) over glass shade (E) and secure with screws (C).

Replacing LED module (Fig.3)

The LED module can be replaced by a qualified electrician without cutting of wire and without damage to any decorative element to which the fixture is attached. See installation steps for more details (Fig 3.)

- a. Shut off the power.
- b. Loosening screws (C), remove decorative frame (G), plastic washers (K) and glass shade (E) from back plate (D).
- c. To remove fixture from wall, loosen screws (C) and back plate (D) from mounting plate (A). Disconnect wire connectors and place back plate (D) on a clean surface.
- d. Press button of printed "L" quick connector on LED module (I) with screwdriver (not included) to disconnected black wire, and then disconnect white wire from printed "N" quick connector on LED module (I).
- e. Remove screws (J) and then remove LED module (I) carefully.
- f. Reverse steps b - e for installing new LED module.

Note: Illustration (Fig. 1) on this manual is for installation purposes only. It may or may not be identical to the fixture purchased.

Dimmable with ELV and/or LED compatible wall dimmer switches.

IMPORTANT: FIXTURE SHOULD BE INSTALLED BY A QUALIFIED ELECTRICIAN TO ENSURE PROPER WIRING AND INSTALLATION.

Fig. 1

Set#A-021-480119
-Mounting Screw *2
-Ground Screw
-Mounting Plate

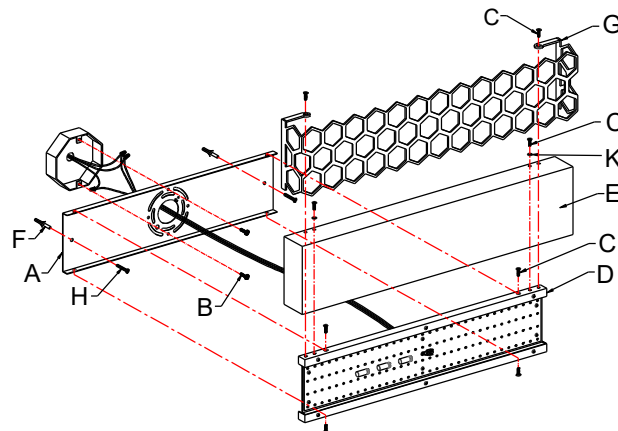

Fig. 2

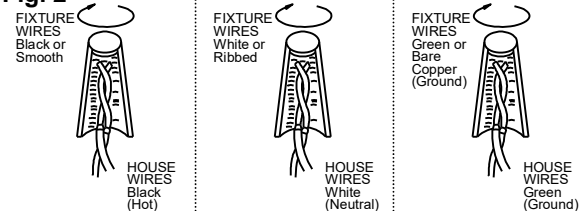

Fig. 3

