

BTCR9U Remote Control

SPECIFICATION and INSTRUCTION SHEET

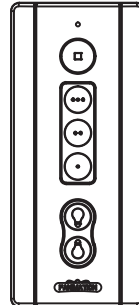

DESCRIPTION: fanSync Bluetooth receiver and transmitter. Transmitter features 3 Speeds, Uplight and Downlight controls. Fan/light off timer function available through FanSync app on your smart devices.

FAN COMPATIBILITY: visit www.fanimation.com/fanSync

IMPORTANT: FOR PULL CHAIN FANS YOU MUST SET CEILING FAN TO HIGH SPEED AND LIGHT KIT (IF ANY) TO ON BEFORE OPERATING REMOTE CONTROL.

1. Read and save these instructions.
2. Please note that all fixed wiring appliances should be installed by a qualified electrician.
3. The supply to the remote control receiver should be connected through a main switch, i.e. existing wall switch.
4. Disconnect from power supply at wall switch before working on remote control receiver or ceiling fan.
5. Install receiver into the ceiling fan canopy of the fan to ensure proper protection.
6. This unit is to be used for the control of ceiling fans connected to an AC120V 60Hz power supply only.
7. Do not install in damp locations or immerse in water (For indoor use only).
8. Do not pull on or cut/shorten receiver leads.
9. Do not drop or subject the unit to any form of impact.

PLEASE NOTE: The battery will weaken with age and should be replaced before leaking takes place as this will damage the transmitter. Dispose of used battery properly and keep the battery out of reach of children.

CAUTION: To reduce the risk of fire or injury, do not use this product in conjunction with any variable (rheostat) wall control.

To assure continued FCC compliance

FEDERAL COMMUNICATIONS COMMISSION INTERFERENCE STATEMENT

This equipment has been tested and found to comply with the limits for a Class B digital device, pursuant to Part 15 of the FCC Rules. These limits are designed to provide reasonable protection against harmful interference in a residential installation. This equipment generates, uses and can radiate radio frequency energy and, if not installed and used in accordance with the instructions, may cause harmful interference to radio communications. However, there is no guarantee that interference will not occur in a particular installation. If this equipment does cause harmful interference to radio or television reception, which can be determined by turning the equipment off and on, the user is encouraged to try to correct the interference by one or more of the following measures: --Reorient or relocate the receiving antenna. --Increase the separation between the equipment and receiver. --Connect the equipment into an outlet on a circuit different from that to which the receiver is connected. --Consult the dealer or an experienced radio/TV technician for help.

CAUTION:

To assure continued FCC compliance:

Any changes or modifications not expressly approved by the grantee of this device could void the user's authority to operate the equipment.

FCC ID: KUJCE10302

This device complies with Part 15 of the FCC Rules. Operation is subject to the following two conditions:

(1) This device may not cause harmful interference, and (2) this device must accept any interference received, including interference that may cause undesired operation.

How to Wire and Operate Your BTCR9U Remote Control





NOTE: If fan or supply wires are different colors than indicated, have this unit installed by a qualified electrician.

CAUTION: INCORRECT WIRE CONNECTION WILL DAMAGE THIS RECEIVER.

1. Ceiling fan must be set at HIGH speed and light kit (if any) in the ON position.
2. Connect wires using connectors as shown in Figure 1.
3. Once the connection has been made, slide the receiver into the hanger bracket, taking care not to pinch the wires. The canopy comes up to cover the receiver and hanger bracket. (Figure 2)
4. **Pairing Process for Receiver & Transmitter:** (Figure 3)
 - The receiver and accompanying transmitter are matched at the factory. If replacing transmitter or receiver, you must follow the pairing process below before using the unit. The fanSync receiver can be paired to up to five (5) transmitters. **NOTE:** Smart device pairing is unlimited.
 - After installing the receiver unit, set desired transmitter code by pushing dip switches (under battery cover) up or down to the desired positions. Once code is set, restore power to your fan and press and hold the fan off button (◻) for approximately 1 to 3 seconds. Fan will turn off, then turn on to medium speed to indicate that the pairing process is complete. Please note that you must press the fan off button (◻) within 30 seconds after restoring power. Re-pairing your device is not necessary after replacing the battery. Each fanSync receiver can pair to five different transmitters (with different dip switch codes). If light kit uses CFL bulbs, please slide the “light dimmer function select switch” to on/off position. If incandescent light bulbs are installed, please slide the “light dimmer function select switch” to dimmer position.

NOTE: Transmitters can pair to multiple receivers, when performing the pairing process take care not to pair the transmitter to unintended receivers. It is suggested that fans more than seven feet apart be on separate power switches.

5. Functions of Transmitter (Figure 4)

-  **UPLIGHT ON/OFF:** Press and release button immediately to turn uplight on or off.
-  **UPLIGHT DIMMER:** Press and hold to dim or brighten light to desired level and release.
-  **DOWN LIGHT ON/OFF:** Press and release button immediately to turn downlight on or off.
-  **DOWNLIGHT DIMMER:** Press and hold to dim or brighten light to desired level and release.

Dimming feature is not available with certain bulbs, i.e. CFLs

- ◻ : Turns off ceiling fan.
- : Turns on ceiling fan to high speed
- : Turns on ceiling fan to medium speed
- : Turns on ceiling fan to low speed

To use your smart device to control your receiver, download the fanSync app from your app store.

6. Installing Wall Plate: (Figure 5)

Attach wall plate using the two provided screws.

⚠ WARNING

To avoid possible electrical shock, be sure electricity is turned off at the main fuse box before wiring. **NOTE:** If you are not sure if the outlet box is grounded, consult with a licensed electrician before proceeding.

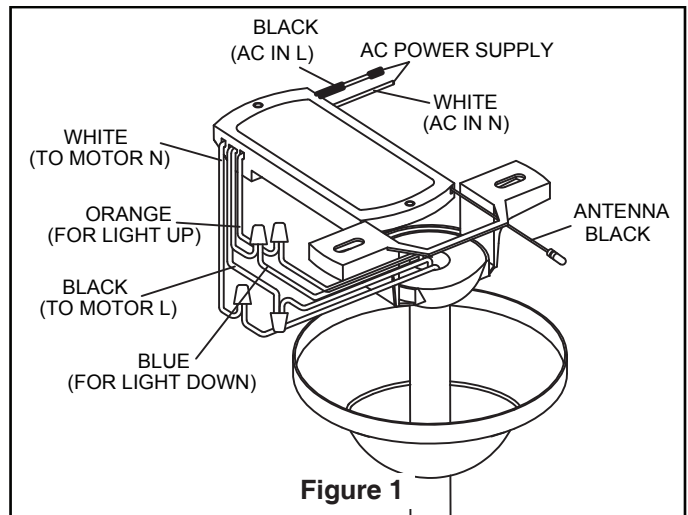

Figure 1

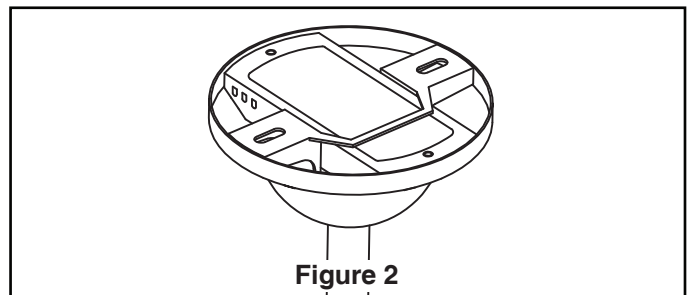

Figure 2

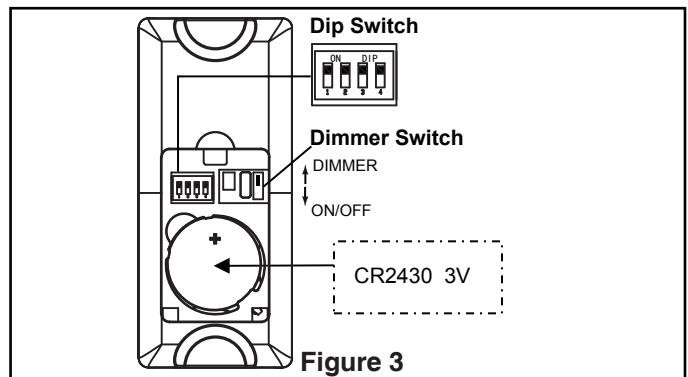

Figure 3

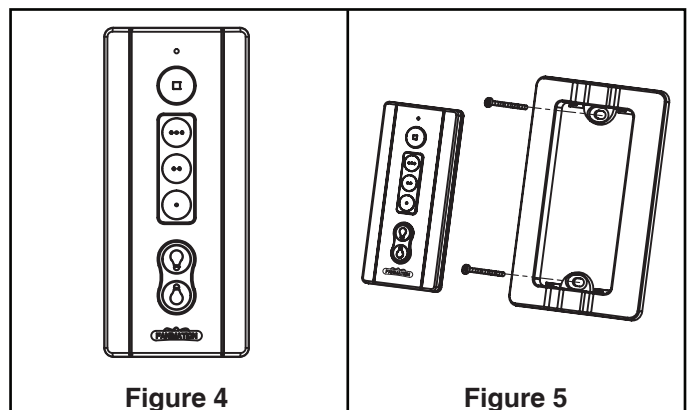

Figure 4

Figure 5