

MODEL NAME **HPD4-CC**
HILUX
4-Inch High-Powered Commercial Downlight

This recessed downlight is a go-to for your commercial projects.



PROJECT: _____ **TYPE:** _____

DATE: _____ **QTY:** _____

NOTES:

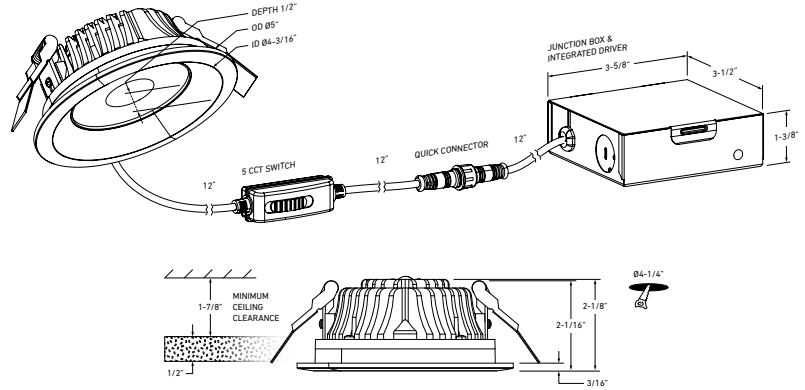

QUICK SPECS

SIZE	WATTS	DELIVERED LUMENS*	COLOR °T 5CCT	CRI	VOLTAGE	BEAM ANGLE	FINISH
4"	20W	1415lm	2700K 3000K 3500K 4000K 5000K	90	120V	90°	○ White ● Black

*Lumen output measured at 3000K

LIGHT DISTRIBUTION

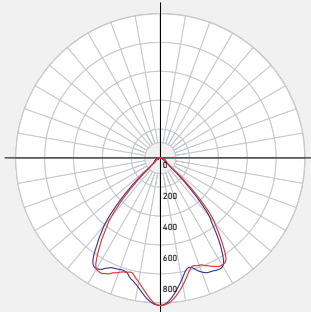

CONSTRUCTION	Lens Clear	Type of optics Reflector	Type of LED COB
	Lens material Glass	Housing material Cast aluminum	Cut hole size 4-1/4"

RATINGS	Placement Indoor/Outdoor	Lifespan 50,000 hrs.	FT rating FT6
	Location Wet	Certifications ETL, FCC, ICES, ES IC, ASTM E283-04, T24	Operating temperature -20° to 40° C

WHAT'S IN THE BOX

- LED recessed fixture
- Junction box
- Push-in wire connectors
- Mounting hardware
- Instruction sheet

ACCESSORIES

- [RFP-UNI](#)
Universal Drilling Plate
- [RFP-46](#)
Drilling Plate

ADAPTERS

- [REC-EXT108](#)
108" extension cord for recessed fixtures
- [REC-EXT230](#)
230" extension cord for recessed fixtures



ELECTRICAL DETAILS	Input voltage 108-135V	Output current 450mA	Power factor 99%	Driver type Constant current
	Output voltage 30-42V	LED model # COB	THD harmonic distortion <30%	Binning type 3 SDCM

FEATURES	Every fixture includes a junction box with an integrated driver	Superior LED performance and lifespan	Switch-selectable CCT: 2700K / 3000 K / 3500 K / 4000 K / 5000 K
	Can be daisy chained	Smooth 360° wide spread	

WARRANTY	DALS offers a 5-year warranty from the date of purchase which covers repairs or replacement of defective parts of the housing, optics, and electronics. To contact DALS customer service call 1-877-430-1818 or send an e-mail to info@dals.com .
-----------------	--

RECOMMENDED DIMMER LIST*

BRAND	MODEL #	DIMMER SPECS	GRADE	DIMMING RANGE (%)	MAX LOAD
Dals	SM-DIMSW Smart Dimmer	Triac, 250W LED/CFL	Compatible	Min: 1 / Max: 100	12
Lutron	DVCL-153PR-WH-C	Triac, 150 W Dimmable CFL/LED	Compatible	Min: 7 / Max: 95	7
Lutron	CTCL-153PDH-WH-C	Triac, 150 W Dimmable CFL/LED	Compatible	Min: 7 / Max: 94	7
Lutron	STCL-153PH-WH-C	Triac, 150 W Dimmable CFL/LED	Compatible	Min: 7 / Max: 94	7
Lutron	DVWCL-153PH-WHC	Triac, 150 W Dimmable CFL/LED	Compatible	Min: 7 / Max: 96	7
Lutron	MACL-153MRHW-WHC	Triac, 150 W Dimmable CFL/LED	Compatible	Min: 7 / Max: 94	7
Lutron	DVELV-300P-WH	300W electronic low voltage dimmer	Compatible	Min: 7 / Max: 65	15
Lutron	MA-PRO-WH	ELV, 250W LED/CFL	Compatible	Min: 1 / Max: 80	12
Lutron	Caseta PD-6WCL-WH-R-C	Triac, 300W Dimmable CFL/LED	Compatible	Min: 1 / Max: 92	15
Lutron	Caseta PD-5NE-WH-C	ELV, LED—up to 250 W	Compatible	Min: 1 / Max: 80	12
Lutron	Caseta PD-10NXD-WH	Triac, LED—up to 250 W	Compatible	Min: 1 / Max: 94	12
Leviton	6672-1LW	Triac, 150W Dimmable CFL/LED	Compatible	Min: 14 / Max: 97	7
Leviton	DSM10	Triac, 450W Dimmable CFL/LED	Compatible	Min: 10 / Max: 97	22
Leviton	6674	Triac, 150 W Dimmable CFL/LED	Compatible	Min: 1 / Max: 98	7
Leviton	IPL06-10Z	Triac, 150 W Dimmable CFL/LED	Compatible	Min: 6 / Max: 98	7
Leviton	DSL06-752	Triac, 150 W Dimmable CFL/LED	Compatible	Min: 6 / Max: 97	7
Leviton	D26HD-742-1RW	Triac, 300W LED/CFL	Compatible	Min: 3 / Max: 99	15
Legrand	RHCL453PNICCV4	Triac, 450W Dimmable CFL/LED	Compatible	Min: 3 / Max: 96	22
Legrand	ADTP703TUM4	Triac, 450W Dimmable CFL/LED	Compatible	Min: 2 / Max: 74	22
Legrand	ADPD453LM2	Triac, 450W Dimmable CFL/LED	Compatible	Min: 18 / Max: 97	22
Legrand	RHL373PW	Triac, 250W LED	Compatible	Min: 2 / Max: 95	12
Control 4	C4-APD120-WH	ELV, 120W LED	Compatible	Min: 1 / Max: 100	6
Control 4	C4-FPD120-WH	Triac, 200W LED	Compatible	Min: 1 / Max: 100	10

* Minimal buzzing noise may occur with some dimmers