

## RING CLUSTER 5 PENDANT

Installation Guide

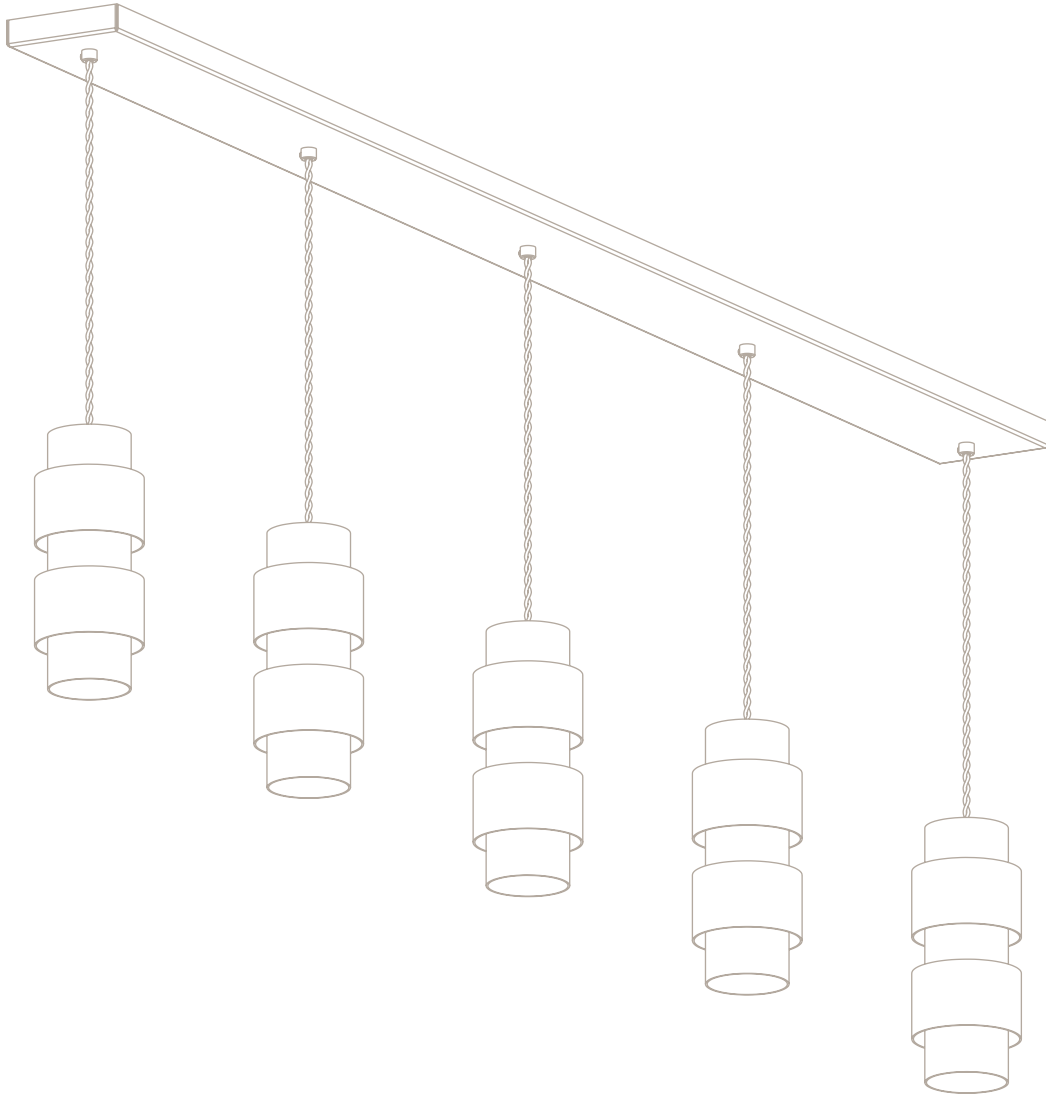

!

Please handle with care and wear gloves at all times during assembly and installation to avoid damaging components.

## TECHNICAL

**Bulb Holder**  
 240v - 5 x E14  
 120v - 5 x E12  
 (no bulbs supplied)

**Wattage**  
 6w 2700k - LED ONLY

**Weight**  
 18kg (39.7lbs)

## PARTS & COMPONENTS

- A. 1 x Ceiling box, 5 x Ring pendants
- B. 1 x Mounting plate
- C. 6 x Screws

A.

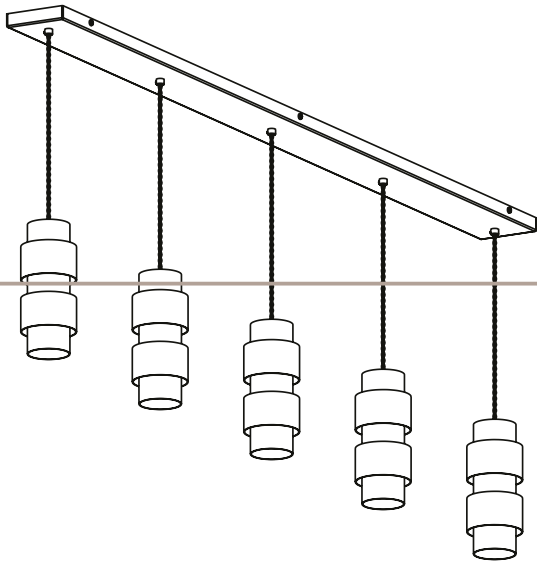

B.

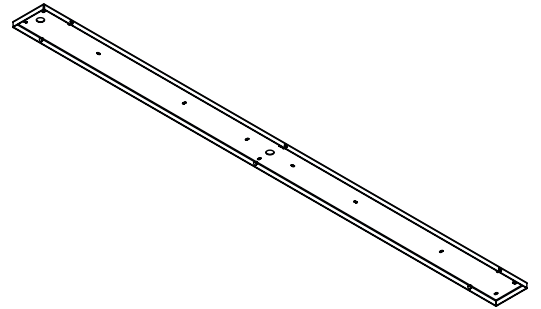

C.



D.

E.

F.

- All nuts and bolts required for the installation will be included in the delivery.



## **BEFORE INSTALLATION**

- Check that you have all components before starting the installation.
  - Installation must be carried out by a qualified electrician.
  - A minimum of two people is required to install a pendant light.
- Check that the ceiling or wall fixings are suitable and strong enough to support the weight of the light fixture.
  - Specific tools are required for a successful installation.

1. Securely fix the mounting plate to the ceiling in the correct position using fixings suitable for the surface you are mounting to (not supplied).

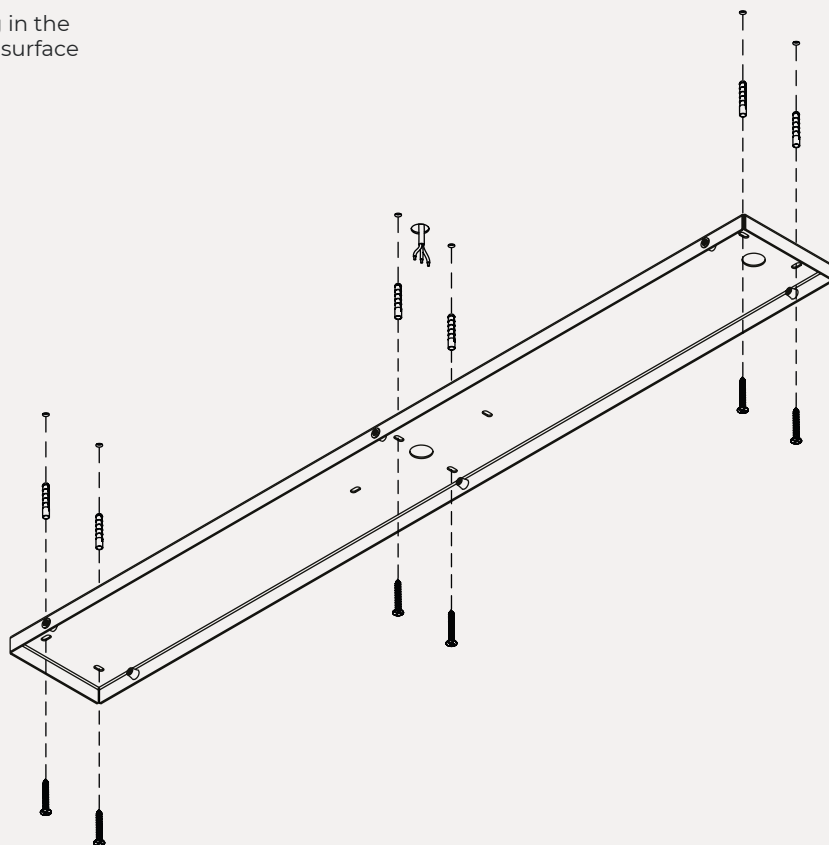

2. Raise the pendant and make the electrical connections inside the ceiling box ensuring all wires are colour matched and the pendant is earthed correctly.

Bring the ceiling box cover up to the mounted plate and secure with the six screws.

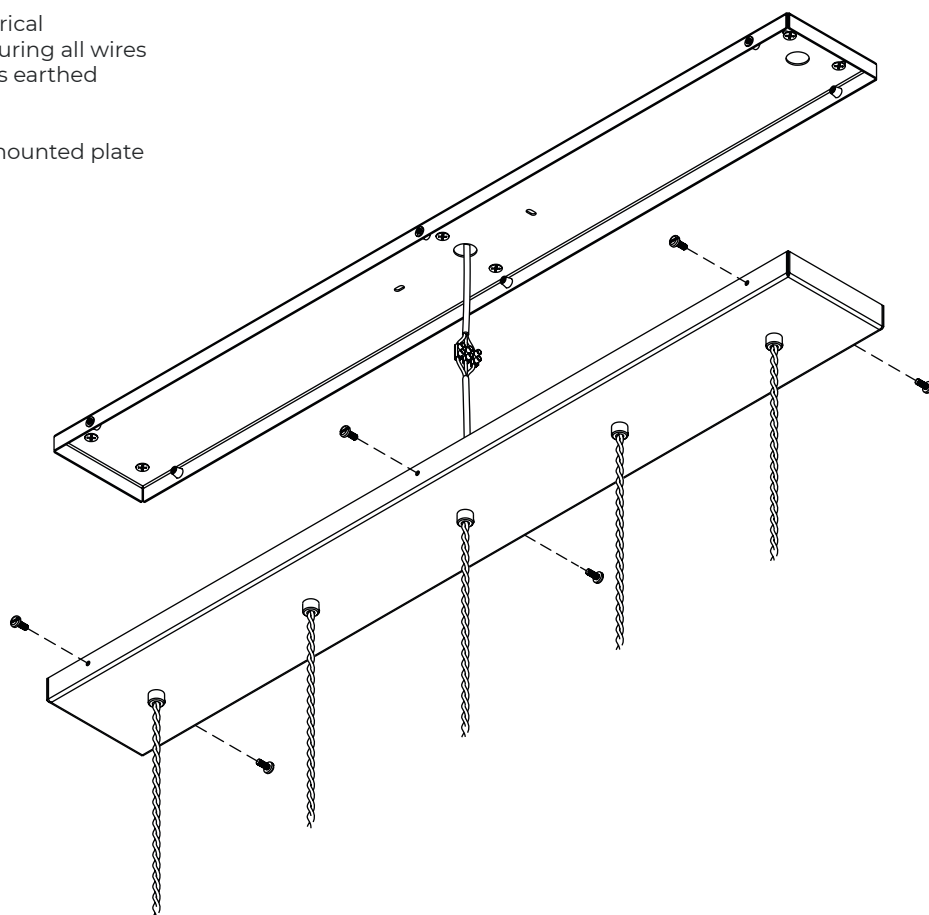

3. If the pendants are not level, whilst supporting the weight of each individual pendant, loosen the grub screw on the cable grip at the top of each cable and adjust the drop.

After adjusting the drop, ensure that the grub screw is fully tightened before releasing the individual pendants you are adjusting.

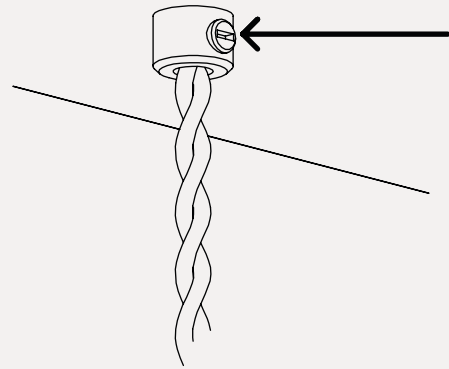

4. With the ceiling box securely fixed to the mounting plate, raise each pendant to access the lampholder.

Fit the bulbs to the lampholders and carefully lower the pendants ensuring that they are sitting level.

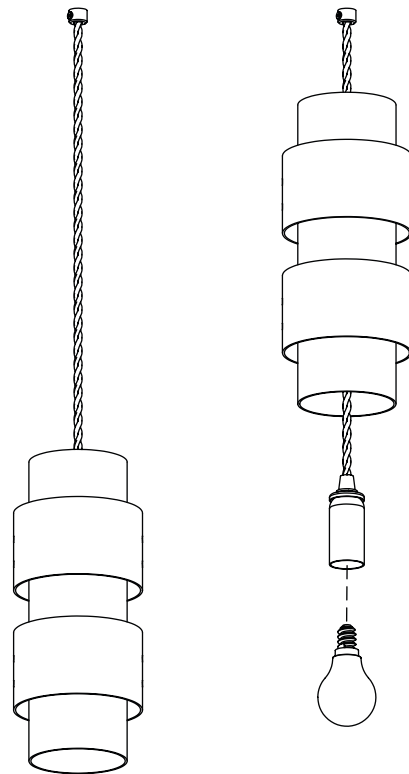

## MAINTENANCE

### Cleaning

Dust using a dry lint-free cloth weekly or as required

### Repairs

Contact  
CTO Lighting

### Warranty

Please visit  
[www.ctolighting/warranty](http://www.ctolighting/warranty)  
for CTO warranty policy

### Certification



E492308