

CRYSTORAMA

LIGHTING THE WAY FOR SIXTY YEARS

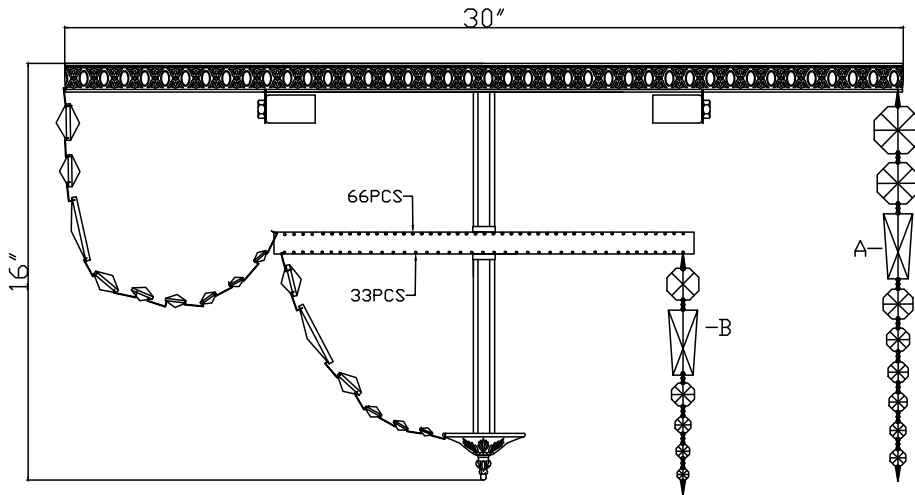

ASSEMBLY INSTRUCTION MODEL #730-OB-CL-SAQ



All electrical components must be installed by a licensed electrician in accordance with the National Electric Code and the appropriate local electrical codes.

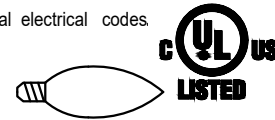

You will need 8- Candelabra Base Bulb
40 Watts recommended 60 Watts Max.
USE LED BULBS FOR EXTENDED USE

The fixture is Dry rated

HOW TO INSTALL:

Place the fixture parts on a soft cloth-covered platform before installation of fixture.

1. Place the cross bar over the outlet box and mark the four points on the ceiling at the same distance as between the two holes on cross bar. See illustration on next page.
2. Drill the holes at the marked points on the all and insert the wall anchors into the holes. Place the mounting bar over the outlet box and secure with anchor screws.
3. Attach the Frame over the mounting bar. After the wire connection is completed, secure with ball nut.
4. Screw the stem onto the coupling on the frame and secure with a hex nut. Slide the smaller tube, check ring, metal ring, check ring, larger tube and check ring in that order over the stem. Secure with a hex nut.
5. Place the vase cap over the end of the stem and secure with the finial.
6. Dress the crystals as illustrated.

Crystal Sets

- A. 66 Sets. (1)32mm + (1)30mm + (1)58mm Baguette + (1)26mm + (1)24mm + (1)22mm + (1)18mm + (1)16mm + (1)14mm
- B. 33 Sets. (1)32mm + (1)58mm Baguette + (1)24mm + (1)16mm + (1)14mm + (1)12mm

WARNING: This product can expose you to Lead, which is known to the State of California to cause cancer and/or birth defects or reproductive harm. For more information go to www.p65warnings.ca.gov

CRYSTORAMA



LIGHTING THE WAY FOR SIXTY YEARS

ASSEMBLY INSTRUCTION MODEL #730-OB-CL-SAQ

Part Number

Part Numbers

- A. (2)-Wire Connector
- B. (1)-Mounting bar
- C. (4)-Wall anchor
- D. (4)-Wall anchor screw
- E. (4)-Screw
- F. (4)-Small hex Nut
- G. (4)-Ball nut-XSN724OBBANUT
- H. (1)-Frame ; Ø30" ; 66 pin holes ; with inner plate.
- I. (4)-Check ring
- J. (1)-Coupling
- K. (2)-Hex Nut
- L. (8)-Socket
- M. (1)-Stem ; H13 3/4"-XSN730OBSTEM13.75IN
- N. (1)-Tube ; H6"-XSN730OBSTEM6IN
- O. (1)-Tube ; H7"-XSN730OBSTEM7IN
- P. (1)-Metal ring ; Ø15" ; 66 pin holes for up side ; 33 pin holes for lower side.
- Q. (1)-Vase Cap ; Ø5" ; 33 pin holes-XSN730OBCAP
- R. (1)-Finial-XSN710OBFIN

