

⚠ WARNING
DISCONNECT POWER BEFORE RE-LAMPING OR WIRING THE FIXTURE
READ ALL INSTRUCTIONS COMPLETELY BEFORE STARTING INSTALLATION.

⚠ CAUTION

- TO AVOID THE RISK OF FIRE OR SHOCK, FIXTURE MUST BE INSTALLED IN COMPLIANCE WITH ALL APPLICABLE NATIONAL AND LOCAL ELECTRICAL/BUILDING CODES.
- INSTALLATION AND MAINTENANCE OF THIS UNIT REQUIRES AN ELECTRICIAN OR CERTIFIED FACTORY TRAINED TECHNICIAN.
- If an existing fixture is being replaced, remove it and note to which of the wires in the outlet box the fixture was attached. DO NOT SEPARATE ANY OTHER WIRES THAT MAY BE IN THE BOX. DO NOT DAMAGE THE INSULATION OF OLDER WIRING. In regular circumstances the BLACK wire will be the "Hot" lead and the WHITE wire will be the "Neutral" or "Common" lead A GREEN or BARE COPPER wire is the "Ground". In older buildings it is always good practice to reconfirm the polarity of the wiring.

NOTICE

- The important safeguards and instructions outlined on this sheet cannot cover all possible conditions and situations that may occur. it must be understood that common sense, caution and care factors that cannot be built into any product. Caution and care must be supplied by the person(s) installing, operating and caring of this lighting fixture.
- This fixture is designed to be mounted on a correctly installed on 1/2-13 threaded rod secured to structure and standard round or octagon box or a through wiring box with a plaster frame. The box must be securely mounted to the structure of the building. The crossbar and hardware supplied should be used. directly mounting the fixture to the outlet box may make it impossible to correctly align the fixture.
- This fixture is supplied with a 16ft. aircraft cable . This feature allows the fixture to be mounted up to 14ft. in height.

NOTICE:
CALIFORNIA PROP 65: THIS LIGHTING FIXTURE CONTAINS CHEMICALS KNOWN TO THE STATE OF CALIFORNIA TO CAUSE CANCER, BIRTH DEFECTS, AND/OR OTHER REPRODUCTIVE HARM. WASH HANDS AFTER USE.

FIXTURE PREPARATION

1. Remove the fixture, parts and parts bag(s) from the carton.

NOTICE:

- Before discarding the carton, double check to make certain that all parts are found.

FIXTURE INSTALLATION

1. Attach the modified heavy duty zinc plated strap to the junction box. (The green screw should face the floor). Place the modified heavy duty zinc plated strap at the junction box and fasten using the round head screw then fasten the 1/2-13 threaded rod with the corresponding nuts. See FIGURE-01.

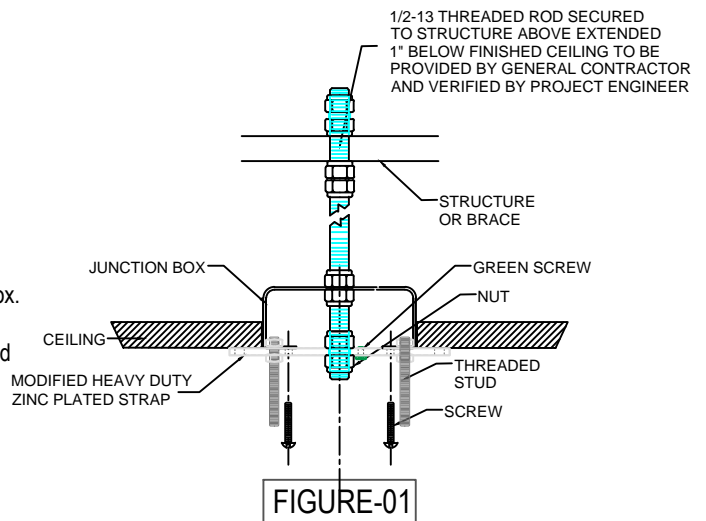

- Determine the overall desired length of the fixture. Insert cables on the cable grip attached on the canopy.

WARNING
 REFER TO THE ILLUSTRATION FOR CORRECT AND SAFE INSTALLATION OF SAFETY CABLE. FAILURE TO FOLLOW THIS INSTRUCTION COULD RESULT HARM/DAMAGE TO THE FIXTURE, PROPERTY AND/OR PERSON(S)!

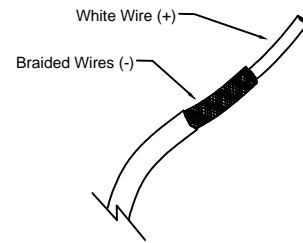

FIGURE-02

- Strip the coaxial cable about 2", exposing 2 wires (braided wire & white wire). (See Figure-02)
- Separate the two wires and tangle the braided wire. (See Figure-03)
- Strip the White Wire by 1/2" as well as to the Braided Wire. (See Figure-04)
- Insert the LED Drivers unto the studs on the inside face of canopy and secure it by tightening the hex nut.

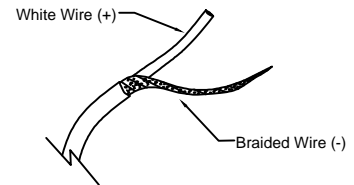

FIGURE-03

- For DC Wire Connection:
 Connect the coaxial cable to the LED Driver (See Figure -05)
 Fasten the white wire of coaxial cable unto the red wire of the LED Driver.
 Fasten the wires together with an approved fastener (wire nut). Starting about 1" below the fastener, tightly wrap the connection with electrical tape so that the connections seals the end of the fastener.

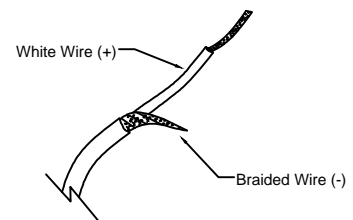
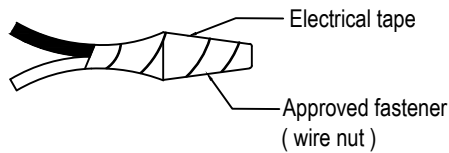

FIGURE-04

WARNING
 Make sure that there is no exposed wire or strands that could cause a dangerous short circuit!

- Connect the braided wire of coaxial cable to the black wire of LED Driver.
 Fasten the joined wires as in step 7.
- For AC Wire Connection:
 LED Driver's white lead to be fasten to the white wire in the outlet box.
 Fasten the wires together with an approved fastener (wire nut). Starting about 1" below the fastener, tightly wrap the connection with electrical tape so that the connections seals the end of the fastener.

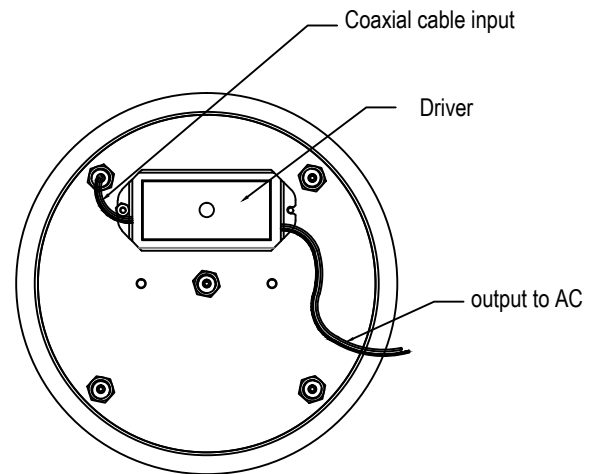
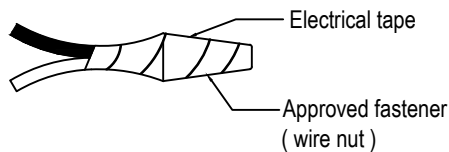

FIGURE-05

WARNING
 Make sure that there is no exposed wire or strands that could cause a dangerous short circuit!

- LED Driver's black lead to be connected to the black wire in the outlet box.
 Fasten the joined wires as in step 9.

11. Fasten the ground wire to the green or bare copper wire in the outlet box or the green screw on the heavy duty strap.
12. Attach the fixture to the mounting threaded studs on modified heavy duty zinc plated strap. Secure the canopy with barrel nuts. (See Figure-06)

WARNING
 REFER TO THE ILLUSTRATION FOR CORRECT AND SAFE INSTALLATION OF FIXTURE.
 FAILURE TO FOLLOW THIS INSTRUCTION COULD RESULT HARM/DAMAGE TO THE
 FIXTURE, PROPERTY AND/OR PERSON(S)!

13. To level the fixture or change the drop height based on your desire height, push the tab down on the grip lock either pull or push the aircraft cable. Repeat this to all aircraft and coaxial cable until the fixture is level and with the desired height.
14. Insert the frosted glass flower to stems labeled with frosted and lock them using the resin ball. (See Figure -07)
15. Insert the bubbles glass flower to stems labeled with bubbles and lock them using the resin ball. (See Figure -07)
16. Insert the clear glass flower to the unlabeled stems and lock them using the resin ball. (See Figure -07)
17. Restore power to the circuit breaker or fuse box.

