

cerno®

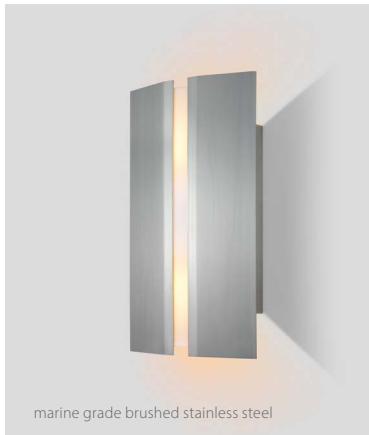

DESIGNED AND MADE IN CALIFORNIA

Rima Outdoor Sconce



marine grade brushed stainless steel



textured black powder coat



textured white powder coat



Rima outdoor sconce

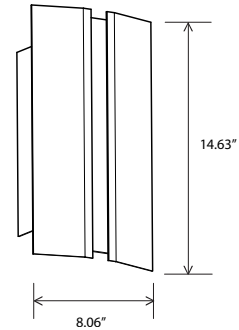

- Dimensions: 14.63" x 8.06" x 3.71"
- Product weight: 2 lb (4 lb Stainless Steel)
- Light source: integrated LED
- Light output: see options below*
- Light color options: 2700 K, 3000K, 3500 K, or 4000 K
- Color accuracy: 90+ CRI
- Power usage: 13 W (standard output)
7 W (reduced output)
- UL listed for wet locations, suitable for indoor and outdoor use
- Specifications subject to change



MATERIAL & FINISH OPTIONS

Rima outdoor part # 03-310-

Shade Finish

- marine grade brushed stainless steel (CM-102) **S**
- textured black powdercoat (CM-099) **K**
- textured white powdercoat (CM-100) **Y**

Lamping

- 2700 K LED **27**
- 3000 K LED **30**
- 3500 K LED **35**
- 4000 K LED **40**

Light Distribution and Driver Options*

Uplight & Downlight

- Standard output - 1130 Lumens (source, at 2700 K)
- 120 V input: TRIAC, ELV & 0-10 V dimmable **P1**
- 240 & 277 V input: only 0-10 V dimmable

- Reduced output - 540 Lumens (source, at 2700 K)
- 120 - 277 V input: Nondimmable **PR**

Includes: frosted polymer (CM-051)

The Rima Outdoor sconce is an illuminating example of functional minimalism. The shade is distilled down to a few essential materials composing a sleek modern design that emits a beautiful quality of light.

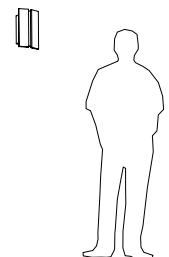

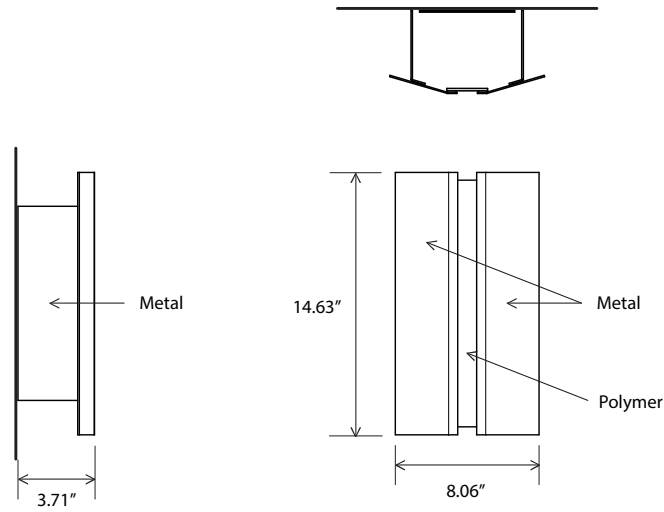

PHOTOMETRIC POLAR GRAPH

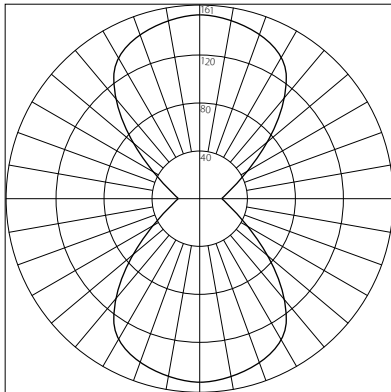

Maximum Candela = 160.66
 Located at:
 Horizontal Angle = 0
 Vertical Angle = 20

Output specifications shown for 2700K CCT and stainless steel finish for vertical plane through 90-270 degree horizontal angles. Other CCTs and material finishes may cause output specifications to vary.

FINISHES



marine grade brushed stainless steel (CM-102)

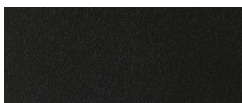

textured black powder coat (CM-099)

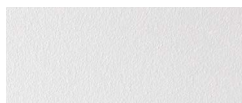

textured white powder coat (CM-100)

▲WARNING. California Proposition 65 Warning for California Consumers. This product can expose you to chemicals including wood dust and lead which are known to the State of California to cause cancer or birth defects or other reproductive harm. For more information go to www.P65Warnings.ca.gov