

MASHIKO 200 SQUARE astro

8266 / SKU 1121057

EN PLEASE READ THE INSTRUCTIONS CAREFULLY

THIS PRODUCT MUST BE INSTALLED IN ACCORDANCE WITH THE APPLICABLE INSTALLATION CODE BY A PERSON FAMILIAR WITH THE CONSTRUCTION AND OPERATION OF THE PRODUCT AND THE HAZARDS INVOLVED CONSULT A QUALIFIED ELECTRICIAN TO ENSURE CORRECT BRANCH CIRCUIT CONDUCTOR.

FR LIRE ATTENTIVEMENT LES INSTRUCTIONS AVANT DE COMMENCER LE MONTAGE

CE PRODUIT DOIT ÊTRE INSTALLÉ SELON LE CODE D'INSTALLATION PERTINENT, PAR UNE PERSONNE QUI CONNAÎT BIEN LE PRODUIT ET SON FONCTIONNEMENT AINSI QUE LES RISQUES INHÉRENTS CONSULTER UN ÉLECTRICIEN QUALIFIÉ POUR VOUS ASSURER QUE LES CONDUCTEURS DE LADÉRIATION SONT ADÉQUATS.

ES LEA DETENIDAMENTE LAS INSTRUCCIONES

ESTE PRODUCTOR DEBE SER INSTALADO SEGUN EL CODIGO DE INSTALACION APLICABLE POR UNA PERSONA QUE CONOZCA LE CONSUSSION Y EL FUNCIONAMIENTO DEL PRODUCTO Y LOS RIESGOS QUE SUPONE. CONSULTAR A UN ELECTRICISTA CALIFICADO PARA ASEGURAR LA ELECCION DEL CONDUCTOR DE CIRCUITO DERIVADO.

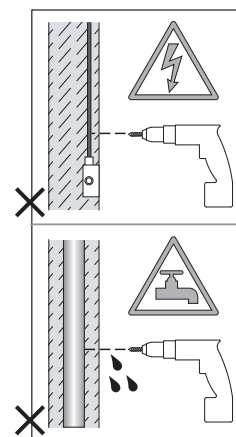

COVERED CEILING MOUNT ONLY
Installation sur plafond couvert seulement
Exclusivamente para fijacion en techo cubierto

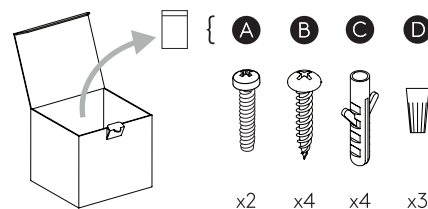
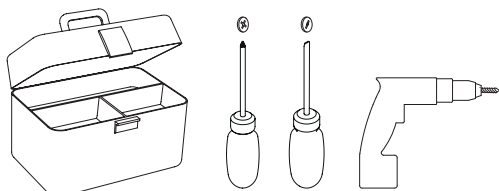

1

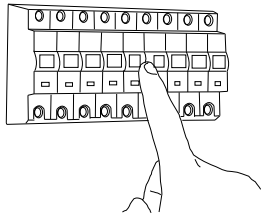

TURN OFF POWER
Couper Le Courant! / Corte La Corriente!

2

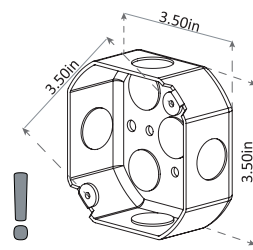

3

<p>WHITE SUPPLY WIRE / NEUTRAL</p> <p>WHITE OR IDENTIFIED FIXTURE WIRE UL LISTED WIRE NUTS</p>	<p>FILS DE COURANT BLANC / NEUTRE</p> <p>FILS DE CONNECTEUR BLANC OU IDENTIFIABLE COINCEUR DE RELAIS UL QUALIFIE</p>	<p>CABLE DE SUMINISTRO BLANCO / NEGATIVO</p> <p>CABLE A LÁMPARA BLANCO / NEGATIVO CONOS ELÉCTRICOS</p>
<p>BLACK SUPPLY WIRE</p> <p>PLAIN OR BLACK FIXTURE WIRE</p>	<p>FILS DE COURANT NOIR</p> <p>FILS DE CONNECTEUR NOIR OU SANS MARQUES</p>	<p>CABLE DE SUMINISTRO NEGRO</p> <p>CABLE A LÁMPARA NEGRO</p>
<p>BARE, OR GREEN GROUND WIRE FROM SUPPLY</p> <p>BARE, OR GREEN FIXTURE GROUND WIRE</p>	<p>FILS VERT OU NEUTRE DU COURANT</p> <p>FILS VERT OU NEUTRE</p>	<p>CABLE DESNUDO / VERDE TIERRA FÍSICA DEL SUMINISTRO</p> <p>CABLE A LÁMPARA VERDE / TIERRA FÍSICA</p>
<p>BARE, OR GREEN GROUND WIRE FROM SUPPLY</p> <p>OR GREEN GROUND SCREW</p>	<p>FILS VERT OU NEUTRE DU COURANT</p> <p>VIS DE TERRE VERTE</p>	<p>CABLE DESNUDO / VERDE TIERRA FÍSICA DEL SUMINISTRO</p> <p>TORNILLO VERDE DE TIERRA</p>

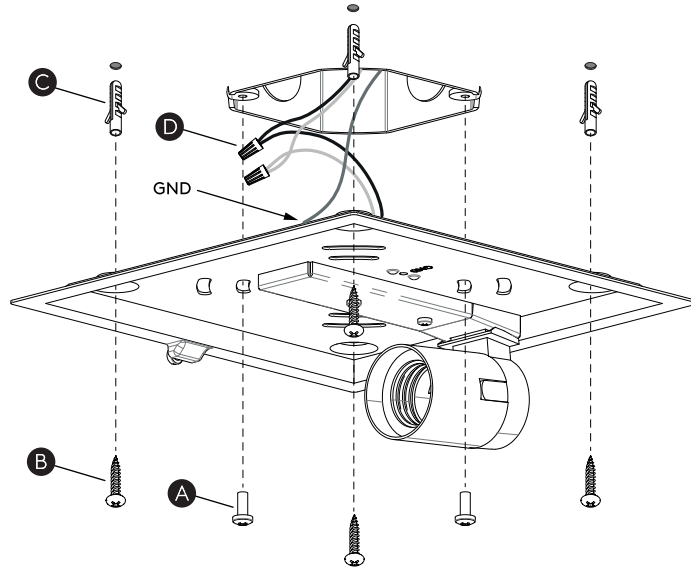

4

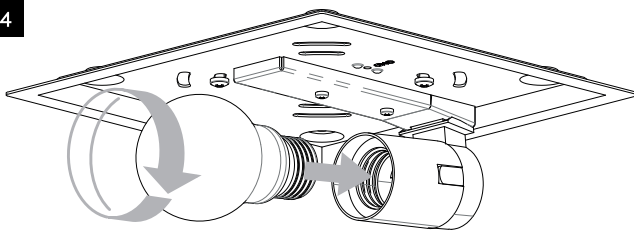

5b

5a

