

ENNA WALL LED

astro

SKU 1058xxx

INSTALLATION INSTRUCTIONS / INSTRUCTIONS D'INSTALLATION / INSTRUCCIONES DE INSTALACIÓN

EN PLEASE READ THE INSTRUCTIONS CAREFULLY

PRODUCTS WITH ELECTRONIC BALLASTS/DRIVERS MUST NOT BE INSTALLED ON THE SAME ELECTRICAL CIRCUITS AS PRODUCTS WITH INDUCTIVE LOADS, FOR EXAMPLE MAGNETIC FLUORESCENT LUMINAIRES, MOTORS OR VENTILATORS. INDUCTIVE LOADS CAN GENERATE EXCESSIVE VOLTAGE SURGES WHICH CAN DAMAGE ELECTRONIC BALLASTS.

THIS PRODUCT MUST BE INSTALLED IN ACCORDANCE WITH THE APPLICABLE INSTALLATION CODE BY A PERSON FAMILIAR WITH THE CONSTRUCTION AND OPERATION OF THE PRODUCT AND THE HAZARDS INVOLVED CONSULT A QUALIFIED ELECTRICIAN TO ENSURE CORRECT BRANCH CIRCUIT CONDUCTOR.

FR LIRE ATTENTIVEMENT LES INSTRUCTIONS AVANT DE COMMENCER LE MONTAGE

LES LUMINAIRES UTILISANT UN BALLAST ÉLECTRONIQUE/DRIVERS NE PEUVENT ÊTRE INSTALLÉS SUR LE MÊME CIRCUIT QUE DES APPAREILS AVEC CHARGES INDUCTIVES, TELS QUE LUMINAIRES FLUORESCENTS MAGNÉTIQUES, MOTEURS ET VENTILATEURS. LES CHARGES INDUCTIVES PEUVENT GÉNÉRER DES VOLTAGES EXCESSIFS ET AINSI ENDOMMAGER LES BALLASTS ÉLECTRONIQUES.

CE PRODUIT DOIT ÊTRE INSTALLÉ SELON LE CODE D'INSTALLATION PERTINENT, PAR UNE PERSONNE QUI CONNAÎT BIEN LE PRODUIT ET SON FONCTIONNEMENT AINSI QUE LES RISQUES INHÉRENTS CONSULTER UN ÉLECTRICIEN QUALIFIÉ POUR VOUS ASSURER QUE LES CONDUCTEURS DE LA DÉRIVATION SONT ADÉQUATS.

ES LEA DETENIDAMENTE LAS INSTRUCCIONES

LOS PRODUCTOS CON REACTANCIAS ELECTRÓNICAS NO DEBEN SER INSTALADOS EN LOS MISMOS CIRCUITOS ELÉCTRICOS QUE LOS PRODUCTOS CON CARGA INDUCTIVA COMO, POR EJEMPLO, LUMINARIAS DE FLUORESCENTES MAGNÉTICOS, MOTORES O VENTILADORES. LA CARGA INDUCTIVA PUEDE GENERAR SOBREVOLTAJES EXCESIVOS QUE PODRIAN DAÑAR LAS REACTANCIAS ELECTRÓNICAS.

ESTE PRODUCTOR DEBE SER INSTALADO SEGUN EL CODIGO DE INSTALACION APLICABLE POR UNA PERSONA QUE CONOZCA LE CONSTUSSION Y EL FUNCIONAMIENTO DEL PRODUCTO Y LOS RIESGOS QUE SUPONE. CONSULTAR A UN ELECTRICISTA CALIFICADO PARA ASEGURAR LA ELECCION DEL CONDUCTOR DE CIRCUITO DERIVADO.

THIS DEVICE COMPLIES WITH PART 15 OF THE FCC RULES. OPERATION IS SUBJECT TO THE FOLLOWING TWO CONDITIONS:
(1) THIS DEVICE MAY NOT CAUSE HARMFUL INTERFERENCE, AND (2) THIS DEVICE MUST ACCEPT ANY INTERFERENCE RECEIVED, INCLUDING INTERFERENCE THAT MAY CAUSE UNDESIRED OPERATION

NOTE: THIS EQUIPMENT HAS BEEN TESTED AND FOUND TO COMPLY WITH THE LIMITS FOR A CLASS B DIGITAL DEVICE, PURSUANT TO PART 15 OF THE FCC RULES. THESE LIMITS ARE DESIGNED TO PROVIDE REASONABLE PROTECTION AGAINST HARMFUL INTERFERENCE IN A RESIDENTIAL INSTALLATION. THIS EQUIPMENT GENERATES, USES AND CAN RADIATE RADIO FREQUENCY ENERGY AND, IF NOT INSTALLED AND USED IN ACCORDANCE WITH THE INSTRUCTIONS, MAY CAUSE HARMFUL INTERFERENCE TO RADIO COMMUNICATIONS. HOWEVER, THERE IS NO GUARANTEE THAT INTERFERENCE WILL NOT OCCUR IN A PARTICULAR INSTALLATION. IF THIS EQUIPMENT DOES CAUSE HARMFUL INTERFERENCE TO RADIO OR TELEVISION RECEPTION, WHICH CAN BE DETERMINED BY TURNING THE EQUIPMENT OFF AND ON, THE USER IS ENCOURAGED TO TRY TO CORRECT THE INTERFERENCE BY ONE OR MORE OF THE FOLLOWING MEASURES:

- REORIENT OR RELOCATE THE RECEIVING ANTENNA.
- INCREASE THE SEPARATION BETWEEN THE EQUIPMENT AND RECEIVER.
- CONNECT THE EQUIPMENT INTO AN OUTLET ON A CIRCUIT DIFFERENT FROM THAT TO WHICH THE RECEIVER IS CONNECTED.
- CONSULT THE DEALER OR AN EXPERIENCED RADIO/TV TECHNICIAN FOR HELP. CHANGES OR MODIFICATIONS NOT EXPRESSLY APPROVED BY THE PARTY RESPONSIBLE FOR COMPLIANCE COULD VOID THE USER'S AUTHORITY TO OPERATE THE EQUIPMENT.

CAN ICES-005 (B) / NMB-005 (B)



WALL MOUNT ONLY
Installation murale seulement
Exclusivamente para fijacion en muro



UNSUITABLE FOR DIMMING
Ne convient pour gradateur
No es adecuado para dimmer

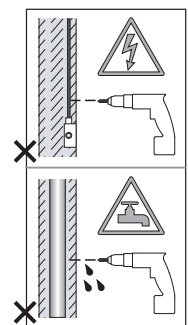
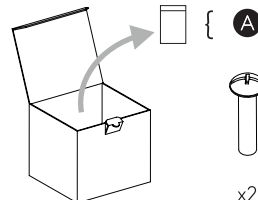
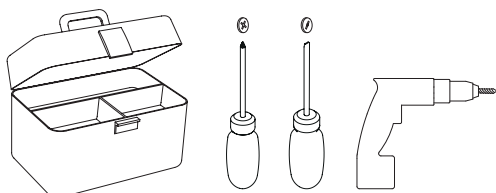

1

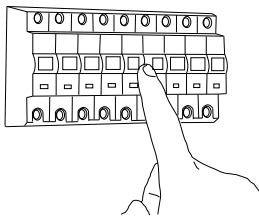

TURN OFF POWER
Couper Le Courant! /
Corte La Corriente!

2

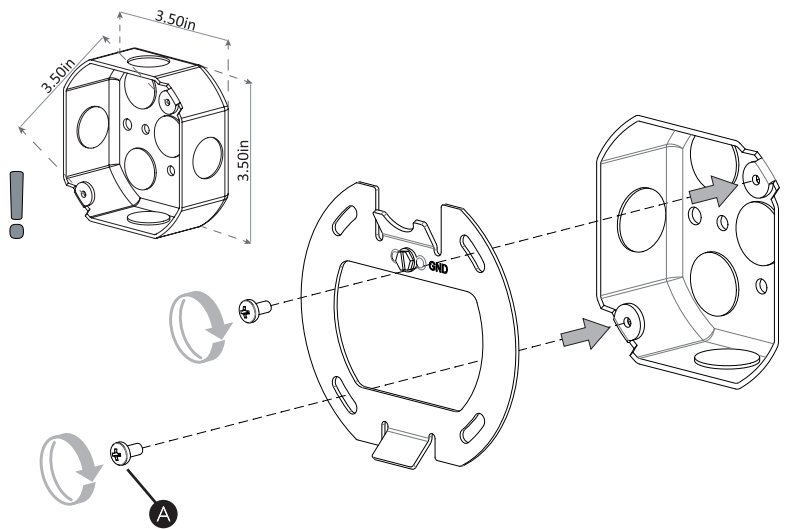

3

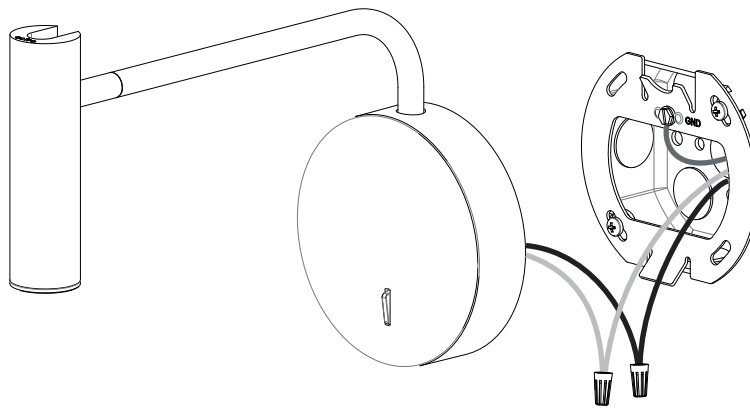

<p>WHITE SUPPLY WIRE / NEUTRAL</p> <p>WHITE OR IDENTIFIED FIXTURE WIRE</p> <p>UL LISTED WIRE NUTS</p>	<p>FILS DE COURANT BLANC / NEUTRE</p> <p>FILS DE CONNECTEUR BLANC OU IDENTIFIABLE</p> <p>ÉCROUS DE FIL HOMOLOGUÉS UL</p>	<p>CABLE DE SUMINISTRO BLANCO / NEGATIVO</p> <p>CABLE A LÁMPARA BLANCO / NEGATIVO</p> <p>CONOS ELÉCTRICOS LISTADOS POR UL</p> <p>CABLE A LÁMPARA NEGRO</p>
<p>BLACK SUPPLY WIRE</p> <p>PLAIN OR BLACK FIXTURE WIRE</p>	<p>FILS DE COURANT NOIR</p> <p>FILS DE CONNECTEUR NOIR OU SANS MARQUES</p>	<p>CABLE DE SUMINISTRO NEGRO</p> <p>CABLE A LÁMPARA NEGRO</p>
<p>BARE, OR GREEN GROUND WIRE FROM SUPPLY</p> <p>GREEN GROUND SCREW</p>	<p>FILS VERT OU NEUTRE DU COURANT</p> <p>VIS DE TERRE VERTE</p>	<p>CABLE DESNUDO / VERDE TIERRA FÍSICA DEL SUMINISTRO</p> <p>TORNILLO VERDE DE TIERRA</p>

- ! Use the appropriate UL listed wire nut for the number of conductors in the installation/
Utilisez l'écrou de fil homologué UL approprié pour le nombre de conducteurs dans l'installation/
- Utilice el cono eléctrico apropiado listado por UL para la cantidad de conductores en la instalación

4

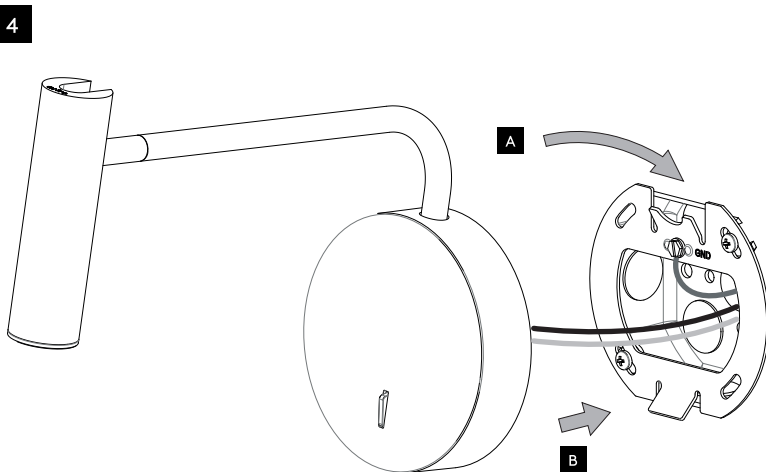

5

