

Arnsberg

Das Licht

customerservice@arnsberg.com

www.arnsberg.com

ASSEMBLY INSTRUCTIONS FOR **SEATTLE** 625211008

Parts Included

Mounting Strap

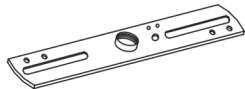

Outlet Box screw

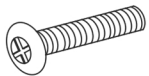

Wire Connector

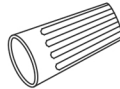

Mounting Screw

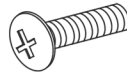

CSA / UL SAFETY REQUIREMENTS

CSA/UL requires that these IMPORTANT SAFETY INSTRUCTION be listed:

- Before starting installation of this fixture or removal of a previous fixture, disconnect the power by turning off the circuit breaker or by removing the fuse at the fuse box.
- Consult a qualified electrician if you have any electrical questions or need to replace the driver.

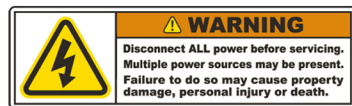

Care Instructions

Arnsberg suggests using only micro fiber cleaning cloth to clean this fixture. If required, a slightly damp cleaning cloth may be used to spot clean. Do not use common household cleaners on this fixture, as the final finish may be damaged as a result. Enjoy your new Arnsberg fixture.

Mounting Instructions

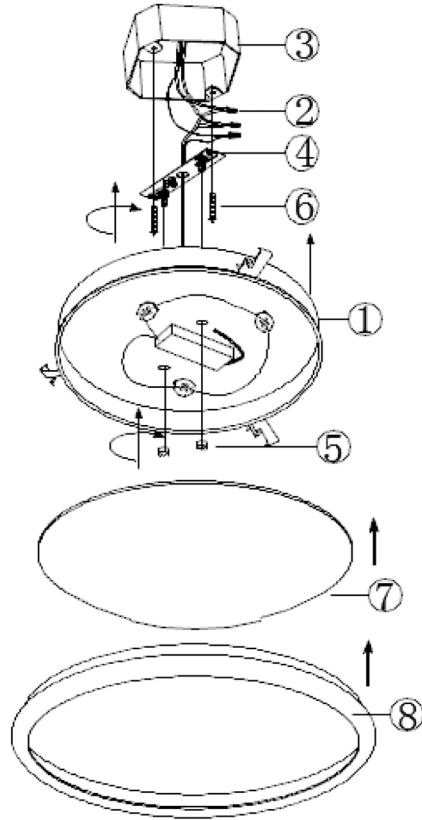

ASSEMBLY INSTRUCTIONS FOR **SEATTLE** 625211008

Assembly Instructions

1. Screw the Outlet Screw (#6) into the Mounting Strap (#4). Mount the Mounting Strap (#4) to the Outlet Box (#3) (Make sure the heads of the Outlet Screw(#6) are facing outside when the Mounting Strap (#4) is attached to the Outlet Box(#3))
2. Connect the ground wire from the fixture to the ground wire from the Outlet Box (#3). Connect the white wire from the fixture to the white wire (neutral wire) from the Outlet Box (#3). Connect the black wire from the fixture to the black wire (live wire) of the Outlet Box (#3). Cover the connections using the Wire Connectors (#2). Wrap the wire connectors with electrical tape for a more secure connection. Position the wires back inside the Outlet Box (#3). Note: If you have electrical questions, consult your local licensed electrician.
3. Place the Canopy (#1) over the Outlet Box(#3) using the End Cap(#5). Attach the Face Glass (#7) to the Canopy(#1), and fasten the Front Ring(#8)
4. Installation is complete, Turn on the power at the circuit breaker of the fuse box. Turn the light switch on to activate the fixture.