

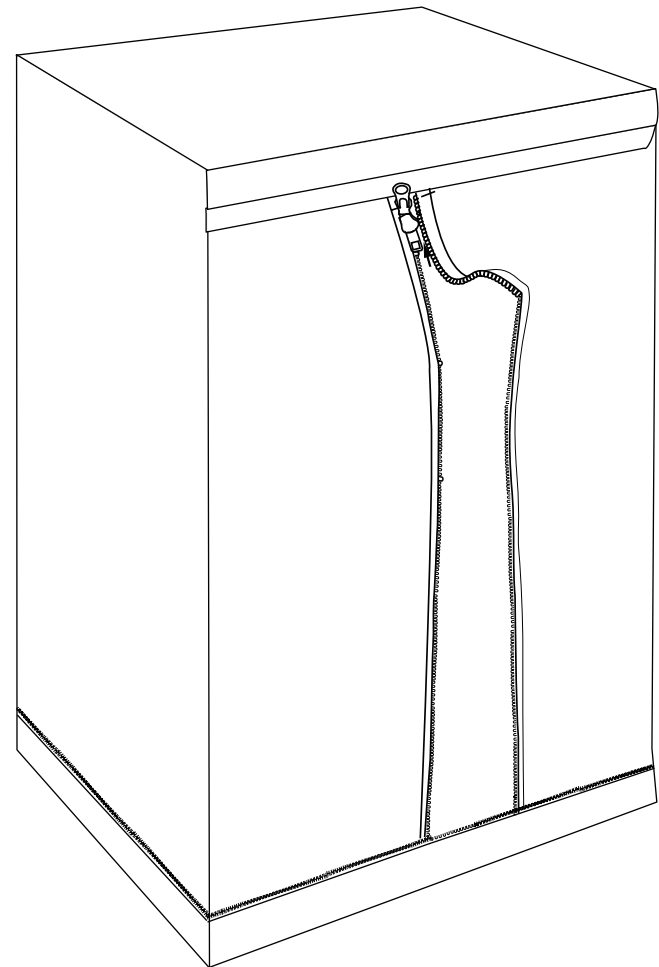

Grow tent ASSEMBLY INSTRUCTIONS

JR - 855040



TENT SIZE: Length: 85cm - Width: 50cm - Height: 40 cm





No tools required

Parts list

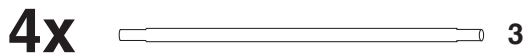
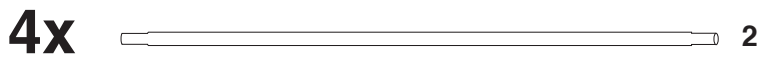
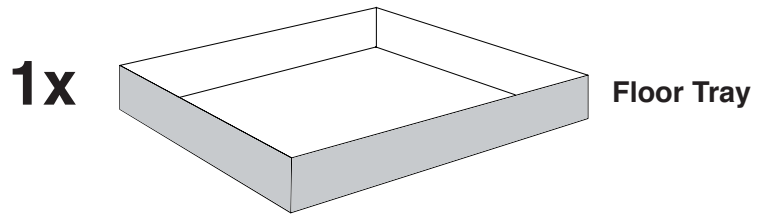
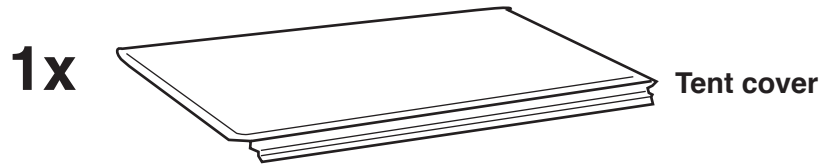

Step9

Close all zippers. All parts have been assembled.

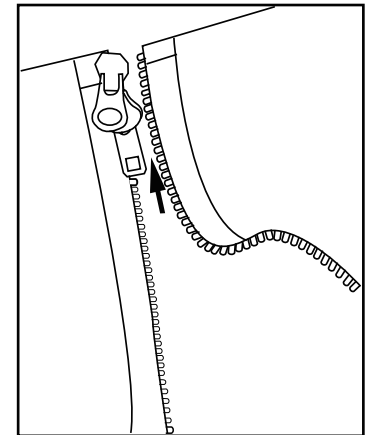
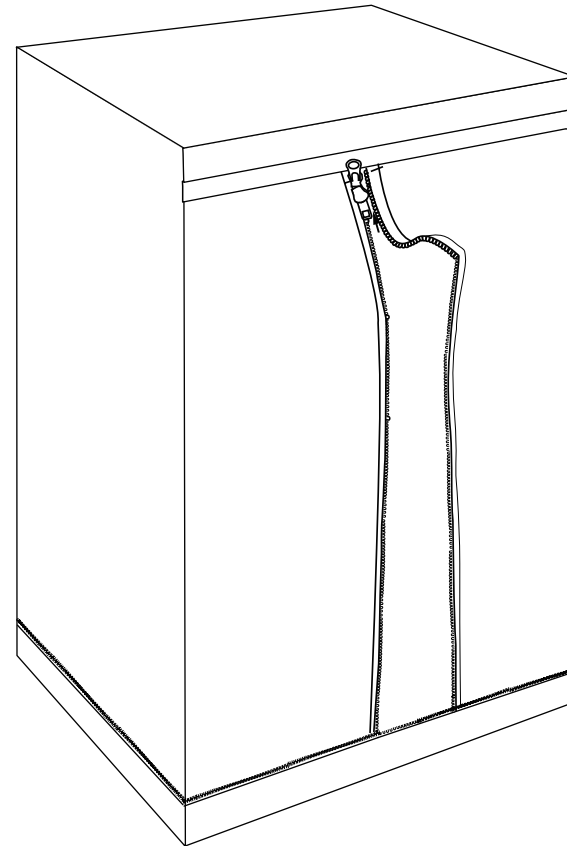

Step3

Unzip all zippers of the tent cover all the way

Step4

Put frame upright on the base of the tent, making sure that all four corners are inside the base.

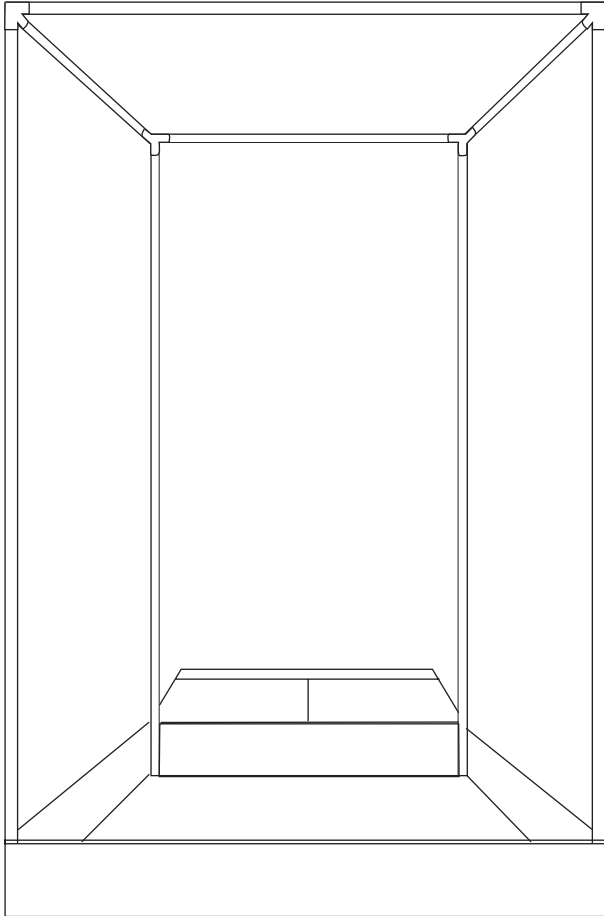

Step5

Gently pull up the back of the tent cover such that the two upper back corners of the cover are squarely in place. Note that having a helper makes this process easier

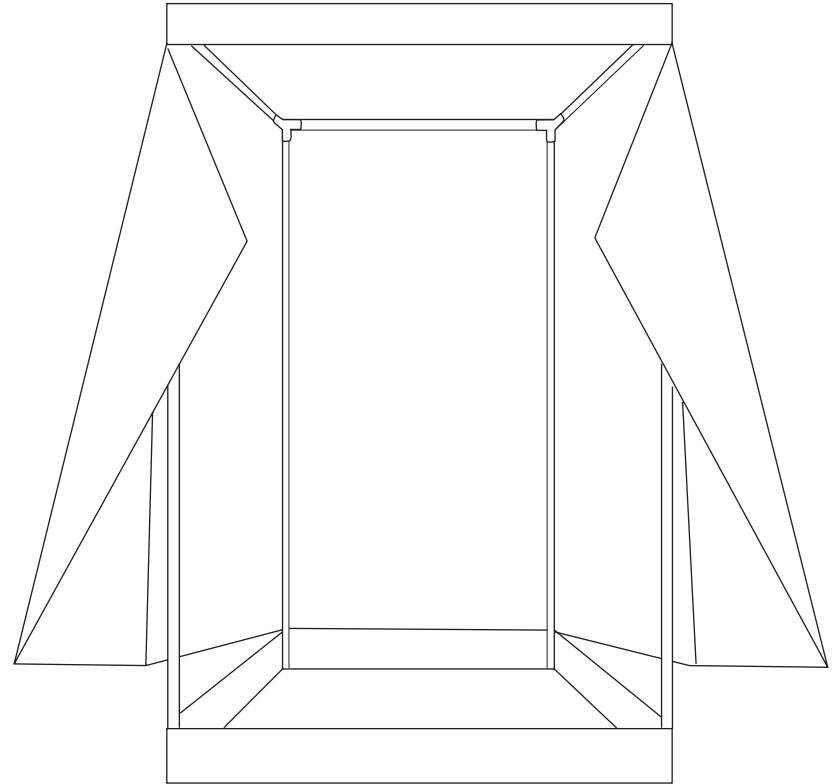

Step6

Gently pull the "roof" of the tent to cover the two upper front corners.

Step7

Gently wriggle/adjust all eight corners until cover is square against the frame

Step8

Place floor tray/liner inside the tent floor and secure to Velcro pieces of the tent cover.

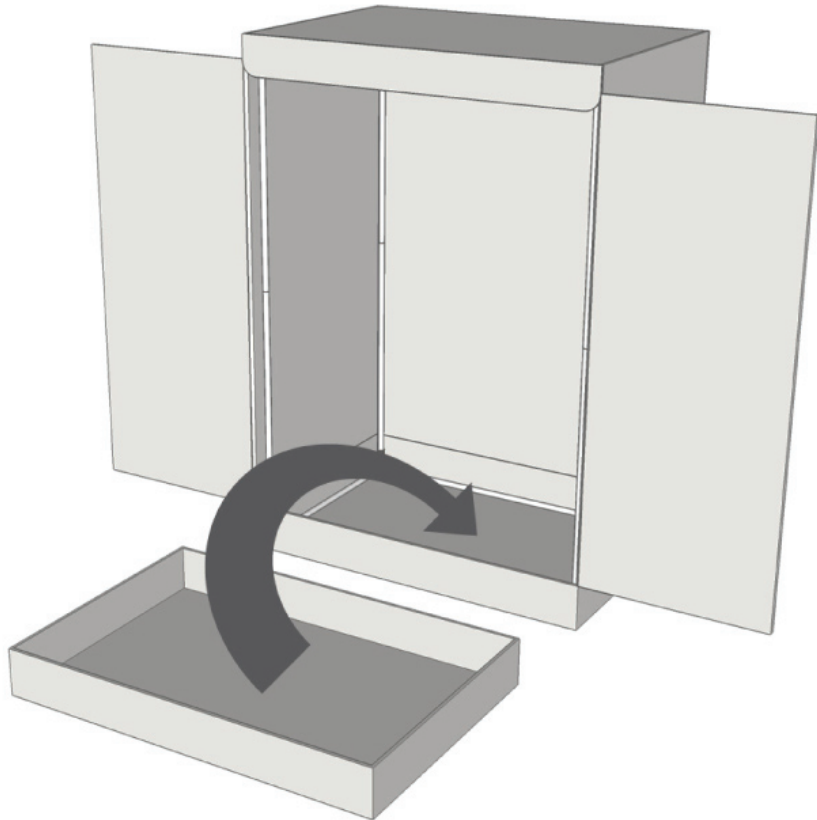

Step1

Connect the poles 1, 2 and 3 to form the complete frame. Once the frame is assembled, make sure that all poles are fully inserted into the corner.

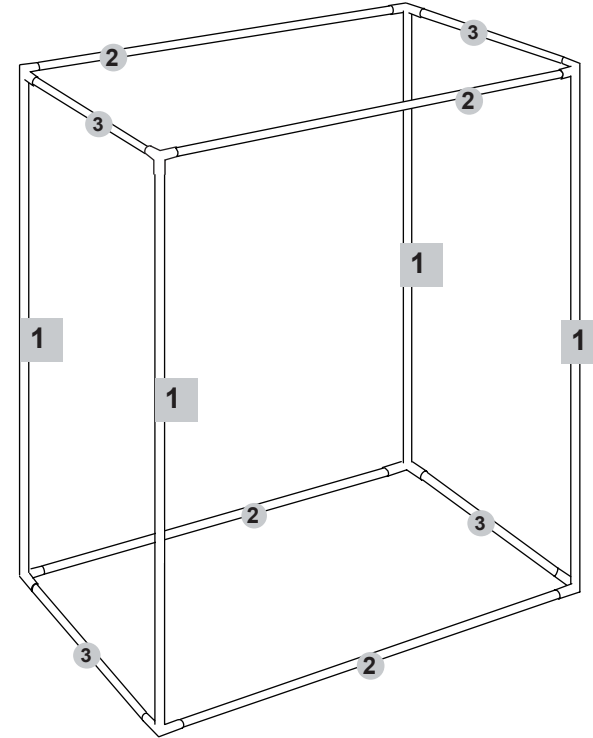

Step2

Place hanging poles 4 on the top of the frame

